

INTERIOR DOORS

2018





40 YEARS OF TRADITION



Dear Partners and Clients,

I would like to express my gratitude for Your trust and loyalty to Erkado brand. Also, I am proud to realise the fact You greatly enjoy our offer.

It is exactly thanks to Your strong feedback, knowledge of the market and involvement that together we can navigate the trends when it comes to the production of interior and exterior doors. Your support is a priceless asset to us and I want to thank again. With every edition of the catalogue we discover and become more aware of the fact that the functionality of doors is only of the aspects. There is more to it and I can say it is the design and innovative solutions.

It is of utmost importance to have Your trust, to share responsible work policy and cooperate in loyal terms.

For more than forty years we have managed the company in an ambitious and flexible way. The result is a strong, dynamic growth that motivates us to take up daring investments. One of them is to expand the production area by ten thousand square metres (thirty thousand currently existing) till the end of 2018.

All this happens thanks to You and for You that is why, I feel honest pleasure to present to You the newest edition of the catalogue - effect of joint passion to doors.

Yours sincerely,

Zbigniew Kozłowski

AWARDS



The mark of responsible forestry
Look for FSC®-certified products

CONTENTS

STILE DOORS	6
ARALIA	6
EWODIA	8
NOLINA	10
DAGLEZJA	12
JUKA BEST PRICE!	14
FORSYCJA BEST PRICE!	16
LAWENDA BEST PRICE!	18
IRYS	20
MAGNOLIA	22
FREZJA	24
DEBECJA	26
NEMEZJA	28
BERBERYS	30
FLOKS	32
KROKUS	34
DALIA	36
KAMELIA	38
PETUNIA	40
MALWA	42
AZALIA	44
HIACYNT	46
FRAGI	48
GRAF GLASS DOORS	50
BOARD DOORS	52
UNO PREMIUM	52
UNO LUX	56
CLASIC	58
UNO	58
BRAND	59
ALEJA LUX	59
DORA	59
MANHATTAN	59
EKA	59
GAMA	59
ALEJA	60
TOLEDO	60
ZEFIR	60
BROADWAY	60
CORTINA	60
GALERIA	60
INTERIOR ENTRANCE DOORS	62
HERSE SET	62
HERSE LUX SET	64
HERSE MAX SET	66
FIXED AND ADJUSTABLE DOOR FRAMES TO HERSE SET	68
METAL DOOR FRAMES TO HERSE SET	70
INTERIOR FIRE RESISTANT DOORS	71
LEDA EI30	71
LEDA EI60	71
WOODEN DOOR FRAME TO LEDA	72
METAL DOOR FRAMES TO LEDA	73
HARDWARE	74
TECHNICAL INFORMATION	80
ON-WALL SLIDING SYSTEM	86
IN-WALL SLIDING SYSTEM	89
DOUBLE DOORS	94
HIDDEN DOORS SYSTEM	97
TRANSOMS	100
DOOR FRAMES	102
ADJUSTABLE FRAME TUNNEL TYPE	105
METAL DOOR FRAMES	106
ADJUSTABLE CASING FRAME TO IRON FRAMES	107
ADJUSTABLE FRAME TO NON-REBATED DOOR LEAF	108
FIXED FRAME TO REBATED DOOR LEAF	109
ADJUSTABLE FRAME TO REBATED DOOR LEAF	110



DECORS

DECORS AVAILABLE TO/FOR INTERIOR DOORS

GREKO, FINISH



GOLDEN OAK GREKO



VENGE GREKO

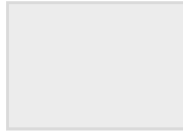

WHITE GREKO



ELM GREKO



GREY OAK GREKO



SANREMO GREKO



NUT GREKO



OAK GREKO



MEDIUM OAK GREKO



SONOMA GREKO



WHITE PINE GREKO



NUT



VENGE



ACACIA



BRIGHT ACACIA

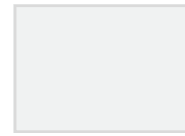

WHITE

PREMIUM



NUT PREMIUM



GREY MAPLE PREMIUM



OAK PREMIUM

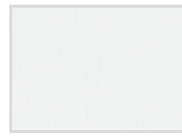

WHITE BARK PREMIUM

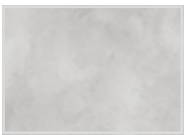

CONCRETE PREMIUM

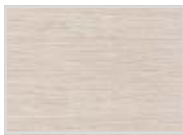

DIAGONAL LARCH



GRAPHITE ASH PREMIUM

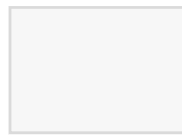

WHITE PREMIUM

CPL



VENGE CPL



VENGE TWIN



GOLDEN OAK TWIN

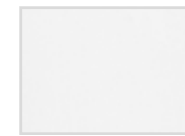

WHITE TWIN



MIDDLE NUT TWIN

SOFT PCV

LAK



ALDER LAK



CALVADOS LAK

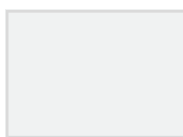

WHITE LAK



OAK LAK



BEECH LAK



STILE INTERIOR DOORS

REBATED AND NON-REBATED



Solid rail 22 mm thick



Esthetic profiled non-rail glazing



Unusual GREKO foil, resistant CPL foil or PREMIUM foil that combines unique structure with practical features



Modern tempered glass; milk and transparent or innovative VSG matt glass

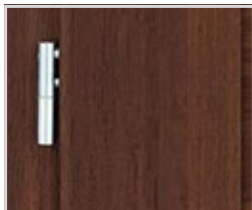

Three regulated hinges set in massive vertical rail 40 mm thick



Solid tenon connections



MDF rail for GREKO and CPL foils



Wooden rail for PREMIUM foil - core made of layer plywood



ARALIA



REBATED AND NON-REBATED INTERIOR STILE DOOR LEAFS



ARALIA 2
WHITE BARK PREMIUM, FUTURA INOX door knob



ARALIA 1



ARALIA 2



ARALIA 3



Presented model: ARALIA 1 in WHITE BARK PREMIUM decor with FUTURA INOX door knob



CONSTRUCTION

- rebated or non-rebated door leaf made in STILE technology
- vertical wooden rails covered with thin HDF in PREMIUM decor
- HDF boards 16mm thick covered with PREMIUM decor (vertical graining)

HARDWARE

- rebated door leaves: three silver pintle hinges regulated horizontally, bolt lock
- non-rebated door leaves: three hidden hinges regulated in three planes, magnetic lock, cylinder lock, economy lock or bathroom lock

GLAZING

- milk decormat glass or VSG 221 security type of glass, smooth on both sides
- possibility to modify glazing for REVERSE (OBVERSE in standard glazing)

AVAILABLE SOLUTIONS (page 86-96)

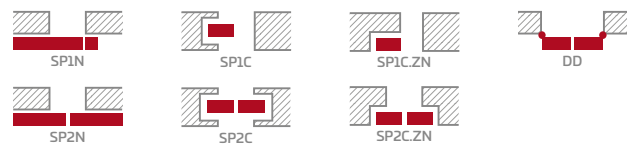

AVAILABLE DOOR WIDTHS



PREMIUM



NUT PREMIUM



GREY MAPLE PREMIUM



OAK PREMIUM

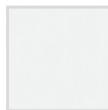

WHITE BARK PREMIUM



GRAPHITE ASH PREMIUM

ACCESSORIES CHARGED ADDITIONALLY

ventilation cut

plastic ventilation sleeves (4 pieces)

metal ventilation grill round and square (4 pieces);
finishing: brushed nickel or patina, white and black

ventilation grill

only for door leaves in widths: 80, 90, 100

rebated and non-rebated door leaf 100 wide

VSG 221 security type of glass, smooth on both sides

metal hinge casings for rebated door leaf

colour: brushed nickel, patina, polished chrome, polished brass, white and black

automatic door seal



EWODIA



REBATED AND NON-REBATED INTERIOR STILE DOOR LEAFS

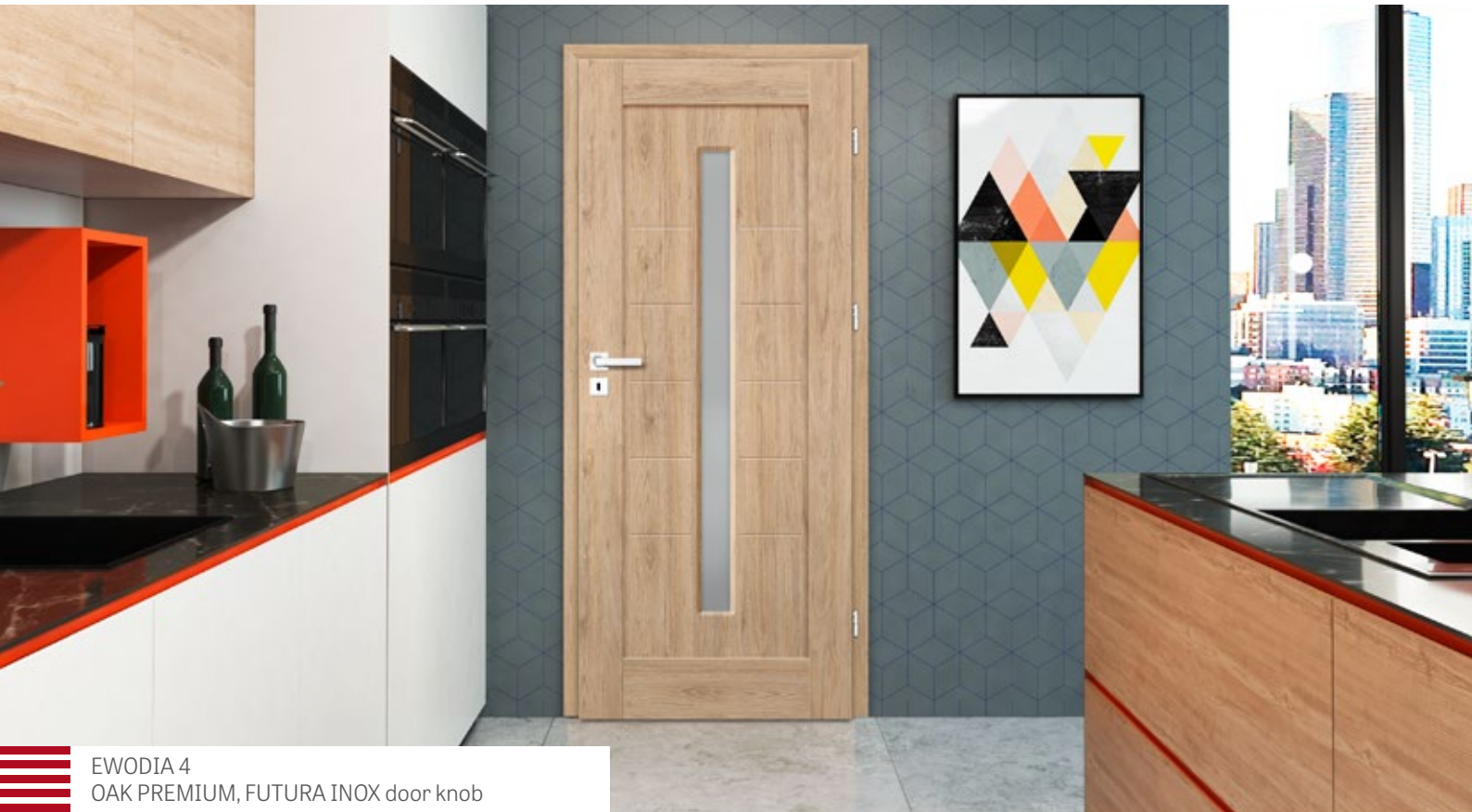

EWODIA 4
OAK PREMIUM, FUTURA INOX door knob



EWODIA 1



EWODIA 2

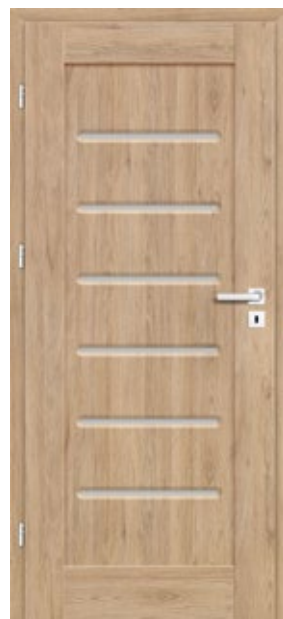

EWODIA 3



EWODIA 4



Presented model: EWODIA 1 in OAK PREMIUM decor with FUTURA INOX door knob



CONSTRUCTION

- rebated or non-rebated door leaf made in STILE technology
- vertical wooden rails covered with thin HDF in PREMIUM decor
- HDF boards 16mm thick covered with PREMIUM decor (vertical graining)

HARDWARE

- rebated door leaves: three silver pintle hinges regulated horizontally, bolt lock
- non-rebated door leaves: three hidden hinges regulated in three planes, magnetic lock, cylinder lock, economy lock or bathroom lock

GLAZING

- milk decormat glass or VSG 221 security type of glass, smooth on both sides
- possibility to modify glazing for REVERSE (OBVERSE in standard glazing)

AVAILABLE SOLUTIONS (page 86-96)

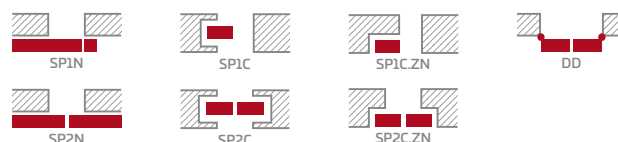

AVAILABLE DOOR WIDTHS



PREMIUM

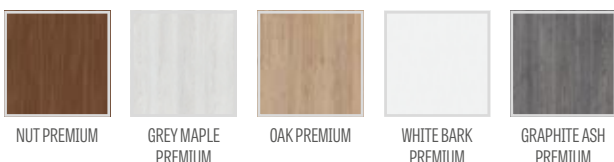

ACCESSORIES CHARGED ADDITIONALLY

ventilation cut

plastic ventilation sleeves (4 pieces)

metal ventilation grill round and square (4 pieces);
finishing: brushed nickel or patina, white and black

ventilation grill

only for door leaves in widths: 80, 90, 100

rebated and non-rebated door leaf 100 wide

VSG 221 security type of glass, smooth on both sides

metal hinge casings for rebated door leaf

colour: brushed nickel, patina, polished chrome, polished brass, white and black

automatic door seal

NOLINA



REBATED AND NON-REBATED INTERIOR STILE DOOR LEAFS



NOLINA 1
GREY MAPLE PREMIUM, FUTURA INOX door knob



NOLINA 1



NOLINA 2



NOLINA 3

Presented model: NOLINA 1 in GREY MAPLE PREMIUM decor with FUTURA INOX door knob



CONSTRUCTION

- rebated or non-rebated door leaf made in STILE technology
- vertical wooden rails covered with thin HDF in PREMIUM decor
- HDF boards 16mm thick covered with PREMIUM decor (vertical graining)

HARDWARE

- rebated door leaves: three silver pintle hinges regulated horizontally, bolt lock
- non-rebated door leaves: three hidden hinges regulated in three planes, magnetic lock, cylinder lock, economy lock or bathroom lock

GLAZING

- milk decormat glass or VSG 221 security type of glass, smooth on both sides
- possibility to modify glazing for REVERSE (OBVERSE in standard glazing)

AVAILABLE SOLUTIONS (page 86-96)

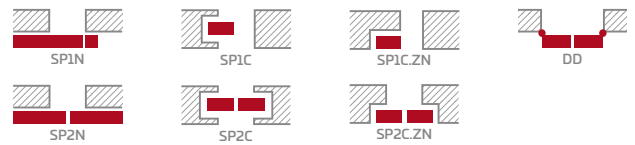

AVAILABLE DOOR WIDTHS



PREMIUM

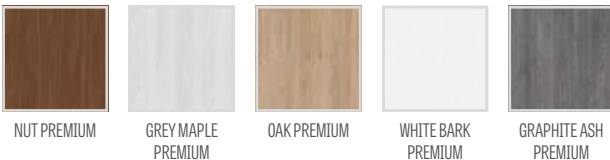

ACCESSORIES CHARGED ADDITIONALLY

ventilation cut

plastic ventilation sleeves (4 pieces)

metal ventilation grill round and square (4 pieces);
finishing: brushed nickel or patina, white and black

ventilation grill

only for door leaves in widths: 80, 90, 100

rebated and non-rebated door leaf 100 wide

VSG 221 security type of glass, smooth on both sides

metal hinge casings for rebated door leaf

colour: brushed nickel, patina, polished chrome, polished brass, white and black

automatic door seal



DAGLEZJA



REBATED AND NON-REBATED INTERIOR STILE DOOR LEAFS



DAGLEZJA 1
GREY OAK GREKO, TUPAI 2275 Q door knob



DAGLEZJA 1



DAGLEZJA 2



DAGLEZJA 3



DAGLEZJA 4



DAGLEZJA 5



DAGLEZJA 6



DAGLEZJA 7



DAGLEZJA 8



Presented model: DAGLEZJA1 in GREY OAK GREKO decor with TUPAI 2275 Q door knob



CONSTRUCTION

- rebated or non-rebated door leaf made in STILE technology
- MDF rails covered in GREKO decors and vertical wooden rails covered with thin HDF in PREMIUM decors
- HDF boards 4mm thick covered with GREKO or PREMIUM decors
- narrow bar

HARDWARE

- rebated door leaves: three silver pintle hinges regulated horizontally, bolt lock
- non-rebated door leaves: three hidden hinges regulated in three planes, magnetic lock, cylinder lock, economy lock or bathroom lock

GLAZING

- milk or transparent hardened glass fixed in standard or VSG 221 security type of glass, smooth on both sides additionally charged
- possibility to modify glazing for REVERSE (OBVERSE in standard glazing)

AVAILABLE SOLUTIONS (page 86-96)

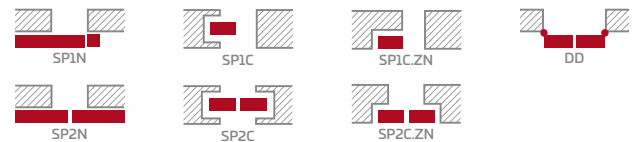

AVAILABLE DOOR WIDTHS



ACCESSORIES CHARGED ADDITIONALLY

ventilation cut

plastic ventilation sleeves (4 pieces)

metal ventilation grill round and square (4 pieces);
finishing: brushed nickel or patina, white and black

ventilation grill
only for door leaves in widths: 80, 90, 100

rebated and non-rebated door leaf 100 wide

VSG 221 security type of glass, smooth on both sides

metal hinge casings for rebated door leaf
colour: brushed nickel, patina, polished chrome, polished brass,
white and black

automatic door seal

GREKO



PREMIUM

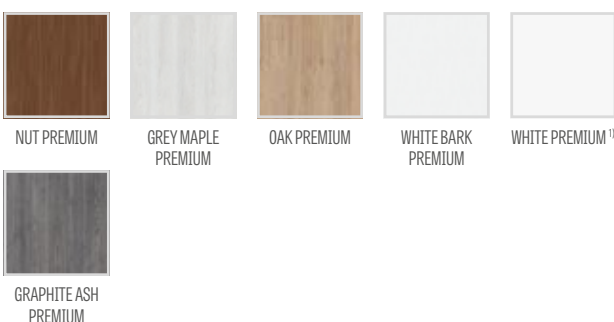

¹⁾ white foil imitating painting surface



JUKA

BEST PRICE!



REBATED AND NON-REBATED INTERIOR STILE DOOR LEAFS



JUKA 4
MEDIUM OAK GREKO, FUTURA INOX door knob



JUKA 1



JUKA 2



JUKA 3



JUKA 4



JUKA 5



JUKA 6



JUKA 7



JUKA 8



Presented model: JUKA 1 in MEDIUM OAK GREKO decor with FUTURA INOX door knob



CONSTRUCTION

- rebated or non-rebated door leaf made in STILE technology
- MDF rails covered in GREKO or CPL decors and vertical wooden rails covered with thin HDF in PREMIUM decors
- HDF boards 4mm thick covered with GREKO, CPL or PREMIUM decor

HARDWARE

- rebated door leaves: three silver pintle hinges regulated horizontally, bolt lock
- non-rebated door leaves: three hidden hinges regulated in three planes, magnetic lock, cylinder lock, economy lock or bathroom lock

GLAZING

- milk or transparent hardened glass fixed in standard or VSG 221 security type of glass, smooth on both sides additionally charged
- possibility to modify glazing for REVERSE (OBVERSE in standard glazing)

AVAILABLE SOLUTIONS (page 86-96)

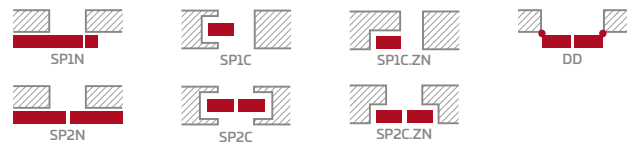

AVAILABLE DOOR WIDTHS



ACCESSORIES CHARGED ADDITIONALLY

ventilation cut

plastic ventilation sleeves (4 pieces)

metal ventilation grill round and square (4 pieces); finishing: brushed nickel or patina, white and black

ventilation grill

only for door leaves in widths: 80, 90, 100

rebated and non-rebated door leaf 100 wide

VSG 221 security type of glass, smooth on both sides

metal hinge casings for rebated door leaf

colour: brushed nickel, patina, polished chrome, polished brass, white and black

automatic door seal

GREKO

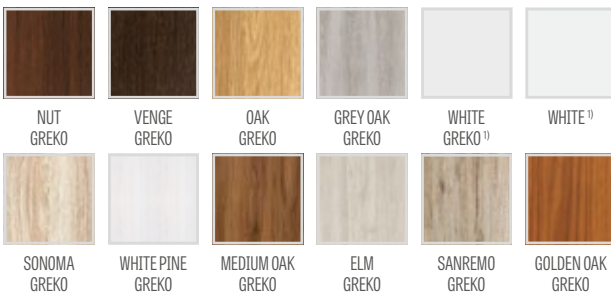

PREMIUM

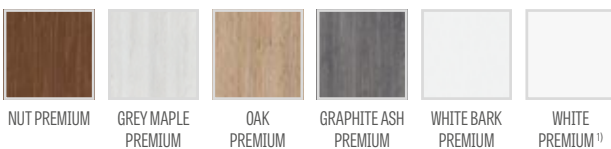

CPL



VENGE CPL

¹⁾ white foil imitating painting surface



FORSYCJA

BEST PRICE!



REBATED AND NON-REBATED INTERIOR STILE DOOR LEAFS



FORSYCJA 1
WHITE GREKO, TUPAI 2275 Q door knob



FORSYCJA 1



FORSYCJA 2



FORSYCJA 3



FORSYCJA 4



FORSYCJA 5



FORSYCJA 6



FORSYCJA 7



FORSYCJA 8



Presented model: FORSYC-JA 4 in WHITE GREKO decor with TUPAI 2275 Q door knob



CONSTRUCTION

- rebated or non-rebated door leaf made in STILE technology
- MDF rails covered in GREKO or CPL decors and vertical wooden rails covered with thin HDF in PREMIUM decors
- HDF boards 4mm thick covered with GREKO, CPL or PREMIUM decor

HARDWARE

- rebated door leaves: three silver pintle hinges regulated horizontally, bolt lock
- non-rebated door leaves: three hidden hinges regulated in three planes, magnetic lock, cylinder lock, economy lock or bathroom lock

GLAZING

- milk or transparent hardened glass fixed in standard or VSG 221 security type of glass, smooth on both sides additionally charged
- possibility to modify glazing for REVERSE (OBVERSE in standard glazing)

AVAILABLE SOLUTIONS (page 86-96)

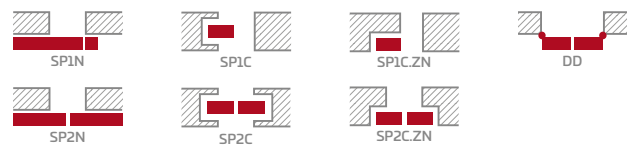

AVAILABLE DOOR WIDTHS



ACCESSORIES CHARGED ADDITIONALLY

ventilation cut

plastic ventilation sleeves (4 pieces)

metal ventilation grill round and square (4 pieces);
finishing: brushed nickel or patina, white and black

ventilation grill

only for door leaves in widths: 80, 90, 100

rebated and non-rebated door leaf 100 wide

VSG 221 security type of glass, smooth on both sides

metal hinge casings for rebated door leaf

colour: brushed nickel, patina, polished chrome, polished brass,
white and black

automatic door seal

GREKO



PREMIUM

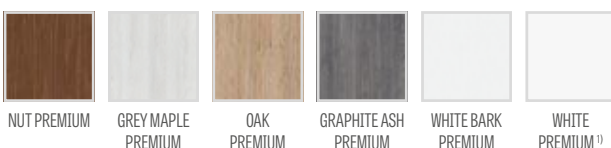

CPL



VENGE CPL

¹⁾ white foil imitating painting surface



LAWENDA

BEST PRICE!



REBATED AND NON-REBATED INTERIOR STILE DOOR LEAFS



LAWENDA 7
OAK GREKO, DECO door knob



LAWENDA 1



LAWENDA 2



LAWENDA 3



LAWENDA 4



LAWENDA 5



LAWENDA 6



LAWENDA 7



LAWENDA 8



LAWENDA 9



Presented model: LAWENDA 1 in OAK GREKO decor with DECO door knob



CONSTRUCTION

- rebated or non-rebated door leaf made in STILE technology
- MDF rails covered in GREKO or CPL decors and vertical wooden rails covered with thin HDF in PREMIUM decors
- HDF boards 4mm thick covered with GREKO, CPL or PREMIUM decor

HARDWARE

- rebated door leaves: three silver pintle hinges regulated horizontally, bolt lock
- non-rebated door leaves: three hidden hinges regulated in three planes, magnetic lock, cylinder lock, economy lock or bathroom lock

GLAZING

- milk or transparent hardened glass fixed in standard or VSG 221 security type of glass, smooth on both sides additionally charged
- possibility to modify glazing for REVERSE (OBVERSE in standard glazing)

AVAILABLE SOLUTIONS (page 86-96)

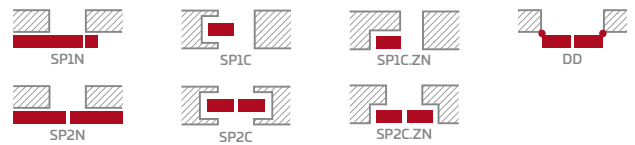

AVAILABLE DOOR WIDTHS

60 70 80 90 100

ACCESSORIES CHARGED ADDITIONALLY

ventilation cut

plastic ventilation sleeves (4 pieces)

metal ventilation grill round and square (4 pieces);
finishing: brushed nickel or patina, white and black

ventilation grill
only for door leaves in widths: 80, 90, 100

rebated and non-rebated door leaf 100 wide

VSG 221 security type of glass, smooth on both sides

metal hinge casings for rebated door leaf
colour: brushed nickel, patina, polished chrome, polished brass,
white and black

automatic door seal

GREKO



PREMIUM

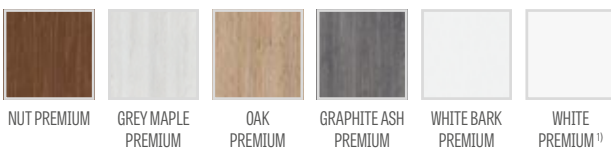

CPL



1) white foil imitating painting surface



IRYS



REBATED AND NON-REBATED INTERIOR STILE DOOR LEAFS



IRYS 1
WHITE PREMIUM, TUPAI 2275 Q door knob



IRYS 1



IRYS 2



IRYS 3



IRYS 4



IRYS 5



IRYS 6



IRYS 7



IRYS 8



Presented model: IRYS 1 in WHITE PREMIUM decor with TUPAI 2275 Q door knob



CONSTRUCTION

- rebated or non-rebated door leaf made in STILE technology
- MDF rails covered in GREKO or CPL decors and vertical wooden rails covered with thin HDF in PREMIUM decors
- HDF boards 4mm thick covered with GREKO, CPL or PREMIUM decor

HARDWARE

- rebated door leaves: three silver pintle hinges regulated horizontally, bolt lock
- non-rebated door leaves: three hidden hinges regulated in three planes, magnetic lock, cylinder lock, economy lock or bathroom lock

GLAZING

- milk or transparent hardened glass fixed in standard or VSG 221 security type of glass, smooth on both sides additionally charged
- possibility to modify glazing for REVERSE (OBVERSE in standard glazing)

AVAILABLE SOLUTIONS (page 86-96)

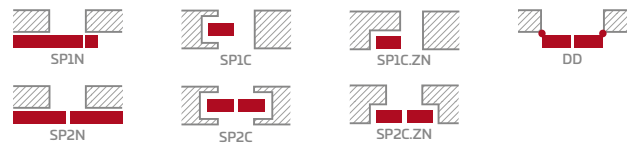

AVAILABLE DOOR WIDTHS

60 70 80 90 100

ACCESSORIES CHARGED ADDITIONALLY

ventilation cut

plastic ventilation sleeves (4 pieces)

metal ventilation grill round and square (4 pieces);
finishing: brushed nickel or patina, white and black

ventilation grill
only for door leaves in widths: 80, 90, 100

rebated and non-rebated door leaf 100 wide

VSG 221 security type of glass, smooth on both sides

metal hinge casings for rebated door leaf
colour: brushed nickel, patina, polished chrome, polished brass,
white and black

automatic door seal

GREKO



PREMIUM

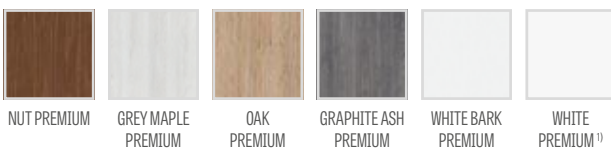

CPL



1) white foil imitating painting surface



MAGNOLIA



REBATED AND NON-REBATED INTERIOR STILE DOOR LEAFS



MAGNOLIA 1
NUT GREKO, DECO door knob



MAGNOLIA 1



MAGNOLIA 2



MAGNOLIA 3



MAGNOLIA 4



MAGNOLIA 5



MAGNOLIA 6



MAGNOLIA 7



MAGNOLIA 8



Presented model: MAGNOLIA 1 in NUT GREKO decor with DECO door knob



CONSTRUCTION

- rebated or non-rebated door leaf made in STILE technology
- MDF rails covered in GREKO or CPL decors and vertical wooden rails covered with thin HDF in PREMIUM decors
- HDF boards 4mm thick covered with GREKO, CPL or PREMIUM decor

HARDWARE

- rebated door leaves: three silver pintle hinges regulated horizontally, bolt lock
- non-rebated door leaves: three hidden hinges regulated in three planes, magnetic lock, cylinder lock, economy lock or bathroom lock

GLAZING

- milk or transparent hardened glass fixed in standard or VSG 221 security type of glass, smooth on both sides additionally charged
- possibility to modify glazing for REVERSE (OBVERSE in standard glazing)

AVAILABLE SOLUTIONS (page 86-96)

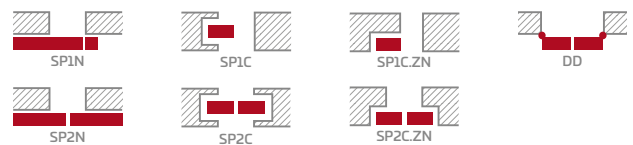

AVAILABLE DOOR WIDTHS



ACCESSORIES CHARGED ADDITIONALLY

ventilation cut

plastic ventilation sleeves (4 pieces)

metal ventilation grill round and square (4 pieces);
finishing: brushed nickel or patina, white and black

ventilation grill
only for door leaves in widths: 80, 90, 100

rebated and non-rebated door leaf 100 wide

VSG 221 security type of glass, smooth on both sides

metal hinge casings for rebated door leaf
colour: brushed nickel, patina, polished chrome, polished brass,
white and black

automatic door seal

GREKO



PREMIUM

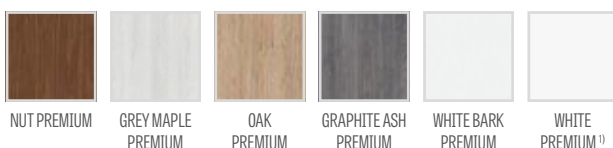

CPL



¹⁾ white foil imitating painting surface

²⁾ vertical rails in WHITE GREKO decor; vertical elements and boards in NUT GREKO decor



FREZJA



REBATED AND NON-REBATED INTERIOR STILE DOOR LEAFS



FREZJA 5
ELM GREKO, MILANO door knob



FREZJA 1



FREZJA 2



FREZJA 3



FREZJA 4



FREZJA 5



FREZJA 6



Presented model: FREZJA 1 in ELM GREKO decor with MILANO door knob



CONSTRUCTION

- rebated or non-rebated door leaf made in STILE technology
- MDF rails covered in GREKO decors and vertical wooden rails covered with thin HDF in PREMIUM decors
- HDF boards 16mm thick (in FREZJA 2 and 6 also 4mm) covered with GREKO or PREMIUM decor

HARDWARE

- rebated door leaves: three silver pintle hinges regulated horizontally, bolt lock
- non-rebated door leaves: three hidden hinges regulated in three planes, magnetic lock, cylinder lock, economy lock or bathroom lock

GLAZING

- milk or transparent hardened glass fixed in standard or VSG 221 security type of glass, smooth on both sides additionally charged
- possibility to modify glazing for REVERSE (OBVERSE in standard glazing)

AVAILABLE SOLUTIONS (page 86-96)

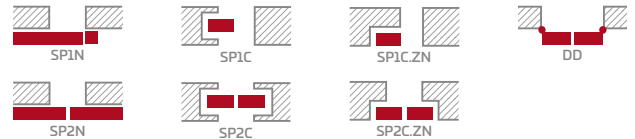

AVAILABLE DOOR WIDTHS

60 70 80 90 100

ACCESSORIES CHARGED ADDITIONALLY

ventilation cut

plastic ventilation sleeves (4 pieces)

metal ventilation grill round and square (4 pieces);
finishing: brushed nickel or patina, white and black

ventilation grill
only for door leaves in widths: 80, 90, 100

rebated and non-rebated door leaf 100 wide

VSG 221 security type of glass, smooth on both sides

metal hinge casings for rebated door leaf
colour: brushed nickel, patina, polished chrome, polished brass,
white and black

automatic door seal

GREKO

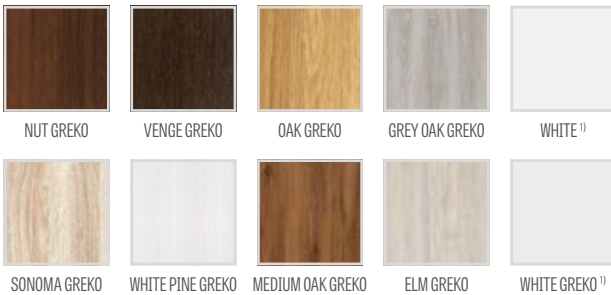

PREMIUM

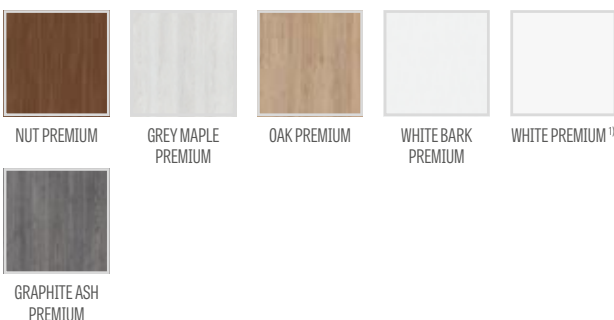

1) white foil imitating painting surface



DEBECJA



REBATED AND NON-REBATED INTERIOR STILE DOOR LEAFS

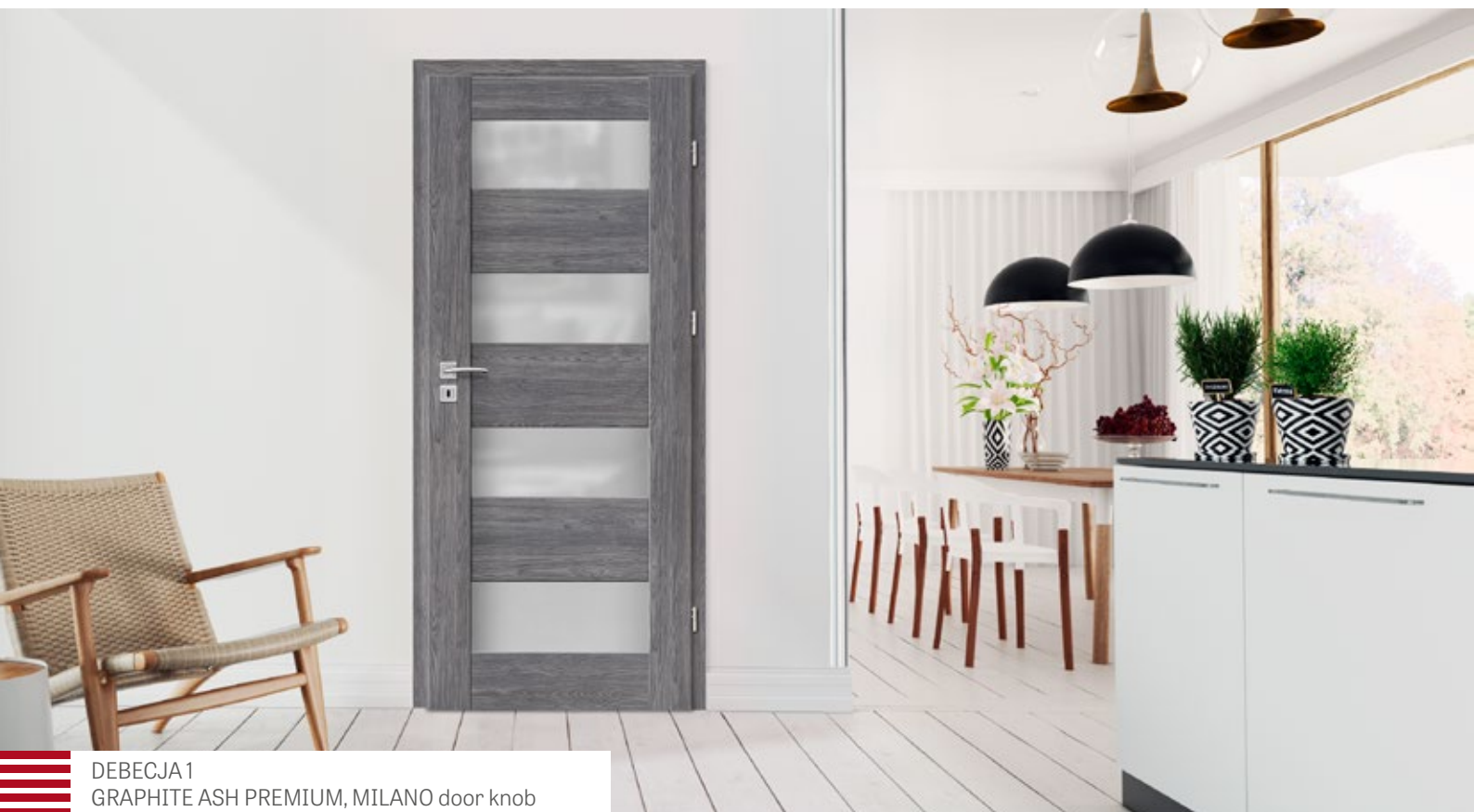

DEBECJA 1
GRAPHITE ASH PREMIUM, MILANO door knob



DEBECJA 1



DEBECJA 2



DEBECJA 3



DEBECJA 4



DEBECJA 5



DEBECJA 6



DEBECJA 7



Presented model: DEBECJA 1 in GRAPHITE ASH PREMIUM decor with MILANO door knob



CONSTRUCTION

- rebated or non-rebated door leaf made in STILE technology
- MDF rails covered in GREKO decors and vertical wooden rails covered with thin HDF in PREMIUM decors
- HDF boards 4mm thick covered with GREKO or PREMIUM decors
- narrow bar

HARDWARE

- rebated door leaves: three silver pintle hinges regulated horizontally, bolt lock
- non-rebated door leaves: three hidden hinges regulated in three planes, magnetic lock, cylinder lock, economy lock or bathroom lock

GLAZING

- milk or transparent hardened glass fixed in standard or VSG 221 security type of glass, smooth on both sides additionally charged
- possibility to modify glazing for REVERSE (OBVERSE in standard glazing)

AVAILABLE SOLUTIONS (page 86-96)

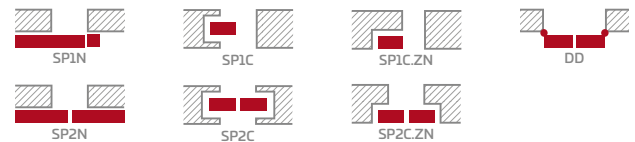

AVAILABLE DOOR WIDTHS



ACCESSORIES CHARGED ADDITIONALLY

ventilation cut

plastic ventilation sleeves (4 pieces)

metal ventilation grill round and square (4 pieces);
finishing: brushed nickel or patina, white and black

ventilation grill
only for door leaves in widths: 80, 90, 100

rebated and non-rebated door leaf 100 wide

VSG 221 security type of glass, smooth on both sides

metal hinge casings for rebated door leaf
colour: brushed nickel, patina, polished chrome, polished brass,
white and black

automatic door seal

GREKO



PREMIUM

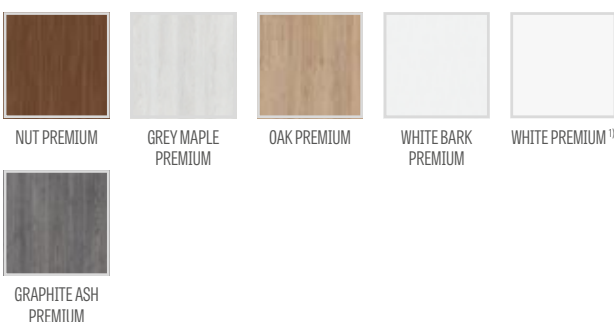

¹⁾ white foil imitating painting surface

NEMEZJA



REBATED AND NON-REBATED INTERIOR STILE DOOR LEAFS



NEMEZJA 7
MEDIUM OAK GREKO, FUTURA INOX door knob



NEMEZJA 1



NEMEZJA 2



NEMEZJA 3



NEMEZJA 4



NEMEZJA 5



NEMEZJA 6



NEMEZJA 7



NEMEZJA 8

Presented model: NEMEZJA 6 in MEDIUM OAK GREKO decor with FUTURA INOX door knob



CONSTRUCTION

- rebated or non-rebated door leaf made in STILE technology
- MDF rails covered in GREKO decors and vertical wooden rails covered with thin HDF in PREMIUM decors
- HDF boards 10 mm thick, chamfered and covered with GREKO or selected PREMIUM decors

HARDWARE

- rebated door leaves: three silver pintle hinges regulated horizontally, bolt lock
- non-rebated door leaves: three hidden hinges regulated in three planes, magnetic lock, cylinder lock, economy lock or bathroom lock

GLAZING

- milk or transparent hardened glass fixed in standard or VSG 221 security type of glass, smooth on both sides additionally charged
- possibility to modify glazing for REVERSE (OBVERSE in standard glazing)

AVAILABLE SOLUTIONS (page 86-96)

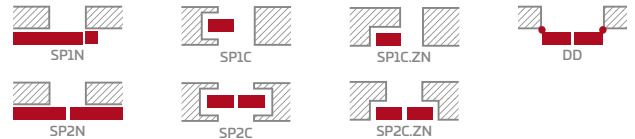

AVAILABLE DOOR WIDTHS



ACCESSORIES CHARGED ADDITIONALLY

ventilation cut

plastic ventilation sleeves (4 pieces)

metal ventilation grill round and square (4 pieces);
finishing: brushed nickel or patina, white and black

ventilation grill
only for door leaves in widths: 80, 90, 100

rebated and non-rebated door leaf 100 wide

VSG 221 security type of glass, smooth on both sides

metal hinge casings for rebated door leaf
colour: brushed nickel, patina, polished chrome, polished brass,
white and black

automatic door seal

GREKO



PREMIUM

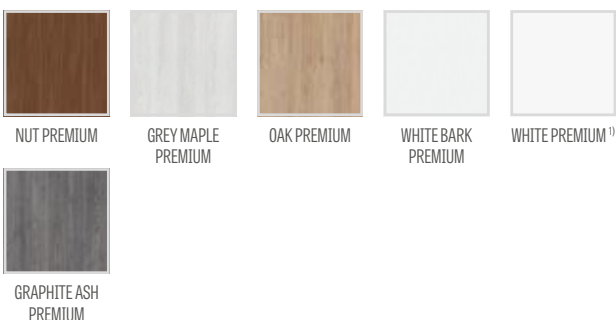

¹⁾ white foil imitating painting surface



BERBERYS



REBATED AND NON-REBATED INTERIOR STILE DOOR LEAFS



BERBERYS 5
GREY MAPLE PREMIUM, FUTURA INOX door knob



BERBERYS 1



BERBERYS 2



BERBERYS 3



BERBERYS 4



BERBERYS 5



BERBERYS 6



BERBERYS 7



BERBERYS 8



Presented model: BERBERYS 1 in GREY MAPLE PREMIUM decor with FUTURA INOX door knob



CONSTRUCTION

- rebated or non-rebated door leaf made in STILE technology
- MDF rails covered in GREKO or CPL decors and vertical wooden rails covered with thin HDF in PREMIUM decors
- HDF boards 4mm thick covered with GREKO, CPL or PREMIUM decor
- brushed aluminium profiles

HARDWARE

- rebated door leaves: three silver pintle hinges regulated horizontally, bolt lock
- non-rebated door leaves: three hidden hinges regulated in three planes, magnetic lock, cylinder lock, economy lock or bathroom lock

GLAZING

- milk or transparent hardened glass fixed in standard or VSG 221 security type of glass, smooth on both sides additionally charged
- possibility to modify glazing for REVERSE (OBVERSE in standard glazing)

AVAILABLE SOLUTIONS (page 86-96)

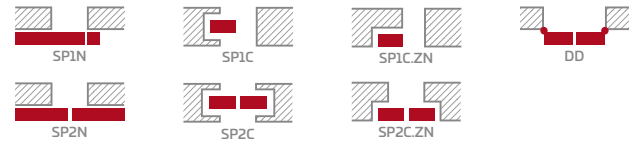

AVAILABLE DOOR WIDTHS



ACCESSORIES CHARGED ADDITIONALLY

ventilation cut

plastic ventilation sleeves (4 pieces)

metal ventilation grill round and square (4 pieces); finishing: brushed nickel or patina, white and black

ventilation grill

only for door leaves in widths: 80, 90, 100

rebated and non-rebated door leaf 100 wide

VSG 221 security type of glass, smooth on both sides

metal hinge casings for rebated door leaf

colour: brushed nickel, patina, polished chrome, polished brass, white and black

automatic door seal

GREKO

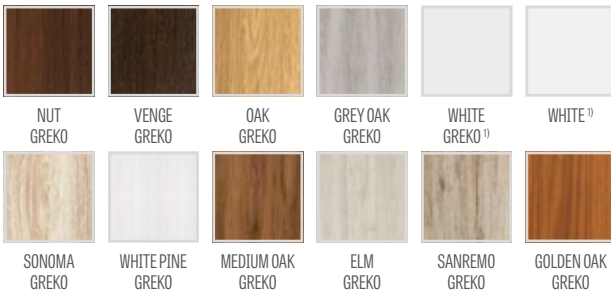

PREMIUM

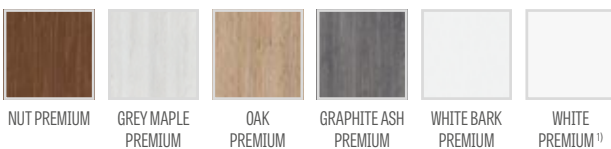

CPL

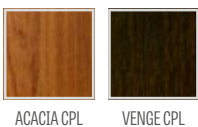

¹⁾ white foil imitating painting surface



FLOKS



REBATED AND NON-REBATED INTERIOR STILE DOOR LEAFS



FLOKS 1
VENGE GREKO, DECO door knob



FLOKS 1



FLOKS 2



FLOKS 3



FLOKS 4



FLOKS 5



FLOKS 6



FLOKS 7



FLOKS 8



Presented model: FLOKS 1 in VENGE GREKO decor with DECO door knob



CONSTRUCTION

- rebated or non-rebated door leaf made in STILE technology
- MDF rails covered in GREKO or CPL decors and vertical wooden rails covered with thin HDF in PREMIUM decors
- HDF boards 4mm thick covered with GREKO, CPL or PREMIUM decor
- brushed aluminium profiles

HARDWARE

- rebated door leaves: three silver pintle hinges regulated horizontally, bolt lock
- non-rebated door leaves: three hidden hinges regulated in three planes, magnetic lock, cylinder lock, economy lock or bathroom lock

GLAZING

- milk or transparent hardened glass fixed in standard or VSG 221 security type of glass, smooth on both sides additionally charged
- possibility to modify glazing for REVERSE (OBVERSE in standard glazing)

AVAILABLE SOLUTIONS (page 86-96)

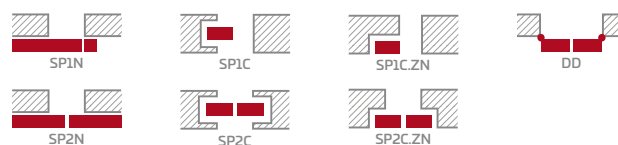

AVAILABLE DOOR WIDTHS



ACCESSORIES CHARGED ADDITIONALLY

ventilation cut

plastic ventilation sleeves (4 pieces)

metal ventilation grill round and square (4 pieces); finishing: brushed nickel or patina, white and black

ventilation grill

only for door leaves in widths: 80, 90, 100

rebated and non-rebated door leaf 100 wide

VSG 221 security type of glass, smooth on both sides

metal hinge casings for rebated door leaf
colour: brushed nickel, patina, polished chrome, polished brass, white and black

automatic door seal

GREKO



PREMIUM

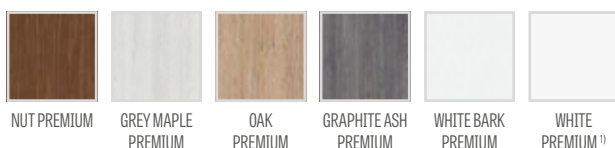

CPL



¹⁾ white foil imitating painting surface



KROKUS



REBATED AND NON-REBATED INTERIOR STILE DOOR LEAFS



KROKUS 1
NUT GREKO, DECO door knob



KROKUS 1



KROKUS 2



KROKUS 3



KROKUS 4



KROKUS 5



KROKUS 6



Presented model: KROKUS 1 in NUT GREKO decor with DECO door knob



CONSTRUCTION

- rebated or non-rebated door leaf made in STILE technology
- MDF rails covered in GREKO or CPL decors and vertical wooden rails covered with thin HDF in PREMIUM decors
- HDF boards 4mm thick covered with GREKO, CPL or PREMIUM decor
- brushed aluminium profiles

HARDWARE

- rebated door leaves: three silver pintle hinges regulated horizontally, bolt lock
- non-rebated door leaves: three hidden hinges regulated in three planes, magnetic lock, cylinder lock, economy lock or bathroom lock

GLAZING

- milk or transparent hardened glass fixed in standard or VSG 221 security type of glass, smooth on both sides additionally charged
- possibility to modify glazing for REVERSE (OBVERSE in standard glazing)

AVAILABLE SOLUTIONS (page 86-96)

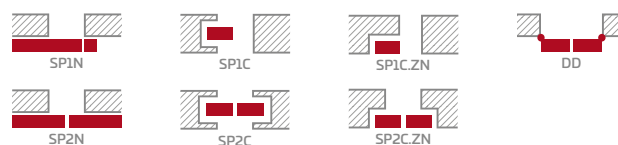

AVAILABLE DOOR WIDTHS



ACCESSORIES CHARGED ADDITIONALLY

ventilation cut

plastic ventilation sleeves (4 pieces)

metal ventilation grill round and square (4 pieces); finishing: brushed nickel or patina, white and black

ventilation grill
only for door leaves in widths: 80, 90, 100

rebated and non-rebated door leaf 100 wide

VSG 221 security type of glass, smooth on both sides

metal hinge casings for rebated door leaf
colour: brushed nickel, patina, polished chrome, polished brass, white and black

automatic door seal

GREKO



PREMIUM

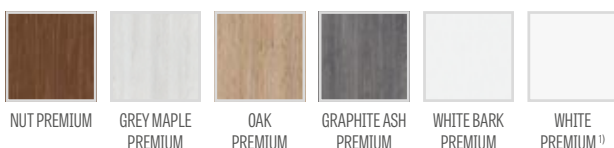

CPL



¹⁾ white foil imitating painting surface



DALIA



REBATED AND NON-REBATED INTERIOR STILE DOOR LEAFS



DALIA 1
OAK GREKO, MILANO door knob



DALIA 1



DALIA 2



DALIA 3



Presented model: DALIA 1 in OAK GREKO decor with MILANO door knob



CONSTRUCTION

- rebated or non-rebated door leaf made in STILE technology
- MDF rails covered with GREKO foils
- HDF boards 12 mm thick, chamfered and covered in selected GREKO decors
- vertical rails in line with horizontal rails

HARDWARE

- rebated door leaves: three silver pintle hinges regulated horizontally, bolt lock
- non-rebated door leaves: three hidden hinges regulated in three planes, magnetic lock, cylinder lock, economy lock or bathroom lock

GLAZING

- milk or transparent hardened glass fixed in standard or VSG 221 security type of glass, smooth on both sides additionally charged
- possibility to modify glazing for REVERSE (OBVERSE in standard glazing)

AVAILABLE SOLUTIONS (page 86-96)

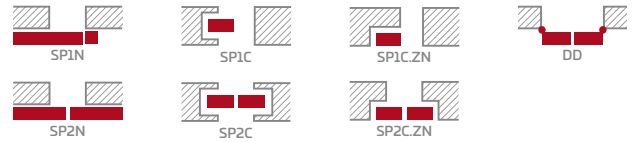

AVAILABLE DOOR WIDTHS

60 70 80 90 100

GREKO



NUT GREKO

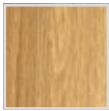

OAK GREKO

ACCESSORIES CHARGED ADDITIONALLY

ventilation cut

plastic ventilation sleeves (4 pieces)

metal ventilation grill round and square (4 pieces);
finishing: brushed nickel or patina, white and black

ventilation grill
only for door leaves in widths: 80, 90, 100

rebated and non-rebated door leaf 100 wide

VSG 221 security type of glass, smooth on both sides

metal hinge casings for rebated door leaf
colour: brushed nickel, patina, polished chrome, polished brass,
white and black

automatic door seal



KAMELIA



REBATED AND NON-REBATED INTERIOR STILE DOOR LEAFS



KAMELIA 1
GRAPHITE ASH PREMIUM, TUPAI 2275 Q door knob



KAMELIA 1



KAMELIA 2



KAMELIA 3



KAMELIA 4



KAMELIA 5



KAMELIA 6



KAMELIA 7



KAMELIA 8



Model KAMELIA 1 in GRAPHITE ASH PREMIUM decor with TUPAI 2275 Q door knob



CONSTRUCTION

- rebated or non-rebated door leaf made in STILE technology
- MDF rails covered in GREKO or CPL decors and vertical wooden rails covered with thin HDF in PREMIUM decors
- HDF boards 4mm thick covered with GREKO, CPL or PREMIUM decor

HARDWARE

- rebated door leaves: three silver pintle hinges regulated horizontally, bolt lock
- non-rebated door leaves: three hidden hinges regulated in three planes, magnetic lock, cylinder lock, economy lock or bathroom lock

GLAZING

- milk or transparent hardened glass fixed in standard or VSG 221 security type of glass, smooth on both sides additionally charged
- possibility to modify glazing for REVERSE (OBVERSE in standard glazing)

AVAILABLE SOLUTIONS (page 86-96)

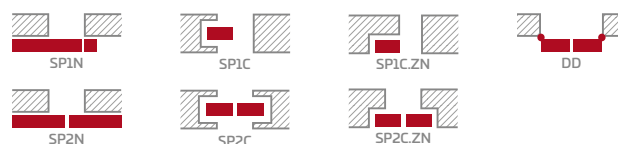

AVAILABLE DOOR WIDTHS



ACCESSORIES CHARGED ADDITIONALLY

ventilation cut

plastic ventilation sleeves (4 pieces)

metal ventilation grill round and square (4 pieces); finishing: brushed nickel or patina, white and black

ventilation grill
only for door leaves in widths: 80, 90, 100

rebated and non-rebated door leaf 100 wide

VSG 221 security type of glass, smooth on both sides

metal hinge casings for rebated door leaf
colour: brushed nickel, patina, polished chrome, polished brass, white and black

automatic door seal

GREKO



PREMIUM



CPL



¹⁾ white foil imitating painting surface

²⁾ vertical rails in WHITE GREKO decor; vertical elements and boards in NUT GREKO decor



PETUNIA



REBATED AND NON-REBATED INTERIOR STILE DOOR LEAFS



PETUNIA 1
OAK PREMIUM, TUPAI 2275 Q door knob



PETUNIA 1



PETUNIA 2



PETUNIA 3



PETUNIA 4



PETUNIA 5



PETUNIA 6



PETUNIA 7



PETUNIA 8



Presented model: PETUNIA 1 in OAK PREMIUM decor with TUPAI 2275 Q door knob



CONSTRUCTION

- rebated or non-rebated door leaf made in STILE technology
- MDF rails covered in GREKO or CPL decors and vertical wooden rails covered with thin HDF in PREMIUM decors
- HDF boards 4mm thick covered with GREKO, CPL or PREMIUM decor

HARDWARE

- rebated door leaves: three silver pintle hinges regulated horizontally, bolt lock
- non-rebated door leaves: three hidden hinges regulated in three planes, magnetic lock, cylinder lock, economy lock or bathroom lock

GLAZING

- milk or transparent hardened glass fixed in standard or VSG 221 security type of glass, smooth on both sides additionally charged
- possibility to modify glazing for REVERSE (OBVERSE in standard glazing)

AVAILABLE SOLUTIONS (page 86-96)

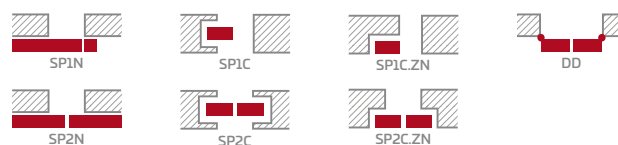

AVAILABLE DOOR WIDTHS



ACCESSORIES CHARGED ADDITIONALLY

ventilation cut

plastic ventilation sleeves (4 pieces)

metal ventilation grill round and square (4 pieces); finishing: brushed nickel or patina, white and black

ventilation grill

only for door leaves in widths: 80, 90, 100

rebated and non-rebated door leaf 100 wide

VSG 221 security type of glass, smooth on both sides

metal hinge casings for rebated door leaf

colour: brushed nickel, patina, polished chrome, polished brass, white and black

automatic door seal

GREKO



PREMIUM

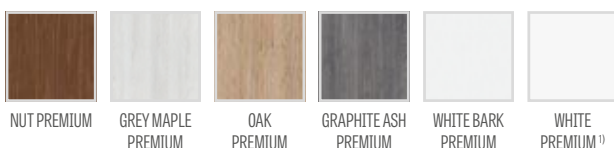

CPL



¹⁾ white foil imitating painting surface

MALWA



REBATED AND NON-REBATED INTERIOR STILE DOOR LEAFS



MALWA 2
SONOMA GREKO, DECO door knob

○ milk glass

● brushed aluminium



MALWA 1

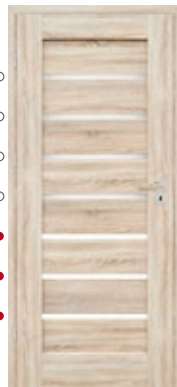

MALWA 2



MALWA 3

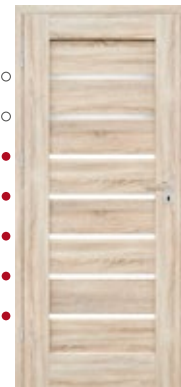

MALWA 4



MALWA 5



MALWA 6



MALWA 7



MALWA 8

Presented model: MALWA 2 in SONOMA GREKO decor with DECO door knob



CONSTRUCTION

- rebated or non-rebated door leaf made in STILE technology
- MDF rails covered in GREKO or CPL decors and vertical wooden rails covered with thin HDF in PREMIUM decors
- HDF boards 4mm thick covered with GREKO, CPL or PREMIUM decor

HARDWARE

- rebated door leaves: three silver pintle hinges regulated horizontally, bolt lock
- non-rebated door leaves: three hidden hinges regulated in three planes, magnetic lock, cylinder lock, economy lock or bathroom lock

GLAZING

- milk or transparent hardened glass fixed in standard or VSG 221 security type of glass, smooth on both sides additionally charged
- possibility to modify glazing for REVERSE (OBVERSE in standard glazing)

AVAILABLE SOLUTIONS (page 86-96)

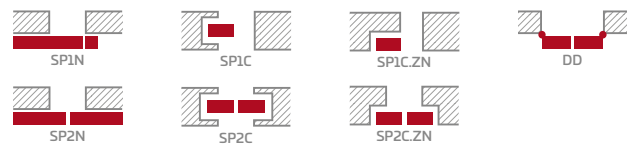

AVAILABLE DOOR WIDTHS



ACCESSORIES CHARGED ADDITIONALLY

ventilation cut

plastic ventilation sleeves (4 pieces)

metal ventilation grill round and square (4 pieces); finishing: brushed nickel or patina, white and black

ventilation grill

only for door leaves in widths: 80, 90, 100

rebated and non-rebated door leaf 100 wide

VSG 221 security type of glass, smooth on both sides

metal hinge casings for rebated door leaf

colour: brushed nickel, patina, polished chrome, polished brass, white and black

automatic door seal

GREKO



PREMIUM

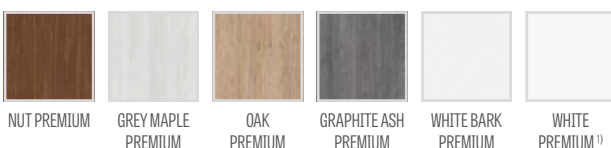

CPL



VENGE CPL

¹⁾ white foil imitating painting surface

AZALIA



REBATED AND NON-REBATED INTERIOR STILE DOOR LEAFS



AZALIA 1
VENGE GREKO, DECO door knob



AZALIA 1



AZALIA 2



AZALIA 3



AZALIA 4



AZALIA 5



AZALIA 6



AZALIA 7



AZALIA 8

Presented model: AZALIA1 in VENGE GREKO decor with DECO door knob



CONSTRUCTION

- rebated or non-rebated door leaf made in STILE technology
- MDF rails covered in GREKO or CPL decors and vertical wooden rails covered with thin HDF in PREMIUM decors
- HDF boards 4mm thick covered with GREKO, CPL or PREMIUM decor

HARDWARE

- rebated door leaves: three silver pintle hinges regulated horizontally, bolt lock
- non-rebated door leaves: three hidden hinges regulated in three planes, magnetic lock, cylinder lock, economy lock or bathroom lock

GLAZING

- milk or transparent hardened glass fixed in standard or VSG 221 security type of glass, smooth on both sides additionally charged
- possibility to modify glazing for REVERSE (OBVERSE in standard glazing)

AVAILABLE SOLUTIONS (page 86-96)

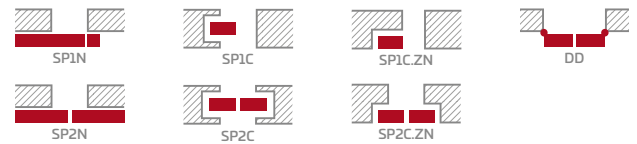

AVAILABLE DOOR WIDTHS



ACCESSORIES CHARGED ADDITIONALLY

ventilation cut

plastic ventilation sleeves (4 pieces)

metal ventilation grill round and square (4 pieces);
finishing: brushed nickel or patina, white and black

ventilation grill
only for door leaves in widths: 80, 90, 100

rebated and non-rebated door leaf 100 wide

VSG 221 security type of glass, smooth on both sides

metal hinge casings for rebated door leaf
colour: brushed nickel, patina, polished chrome, polished brass,
white and black

automatic door seal

GREKO

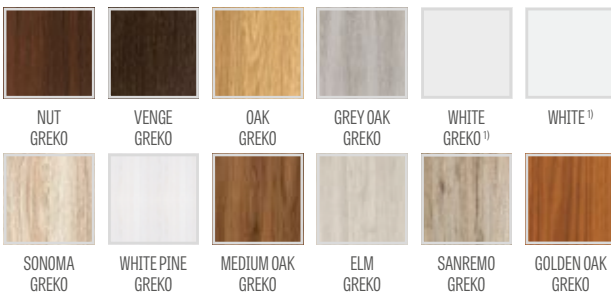

PREMIUM

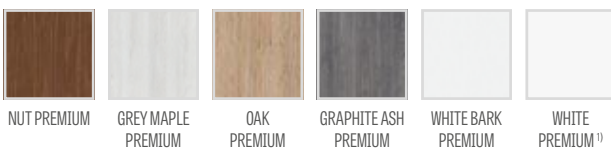

CPL



VENGE CPL

¹⁾ white foil imitating painting surface

HIACYNT



REBATED AND NON-REBATED INTERIOR STILE DOOR LEAFS

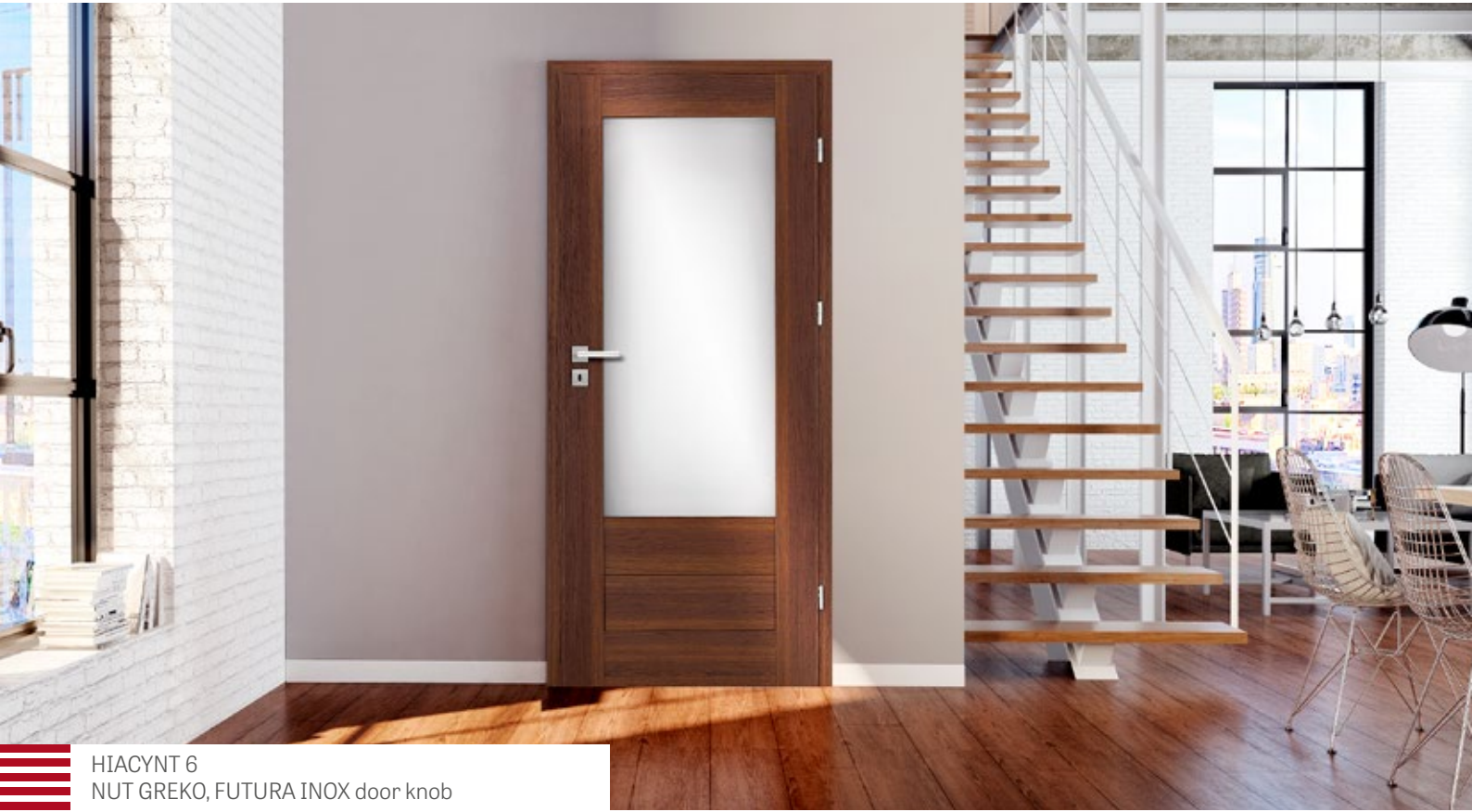

HIACYNT 6
NUT GREKO, FUTURA INOX door knob



HIACYNT 1



HIACYNT 2



HIACYNT 3



HIACYNT 4



HIACYNT 5



HIACYNT 6



HIACYNT 7



HIACYNT 8

Presented model: HIACYNT 1 in MEDIUM OAK GREKO decor with FUTURA INOX door knob



CONSTRUCTION

- rebated or non-rebated door leaf made in STILE technology
- MDF rails covered in GREKO or CPL decors and vertical wooden rails covered with thin HDF in PREMIUM decors
- HDF boards 22 mm thick covered with GREKO, CPL or PREMIUM decors

HARDWARE

- rebated door leaves: three silver pintle hinges regulated horizontally, bolt lock
- non-rebated door leaves: three hidden hinges regulated in three planes, magnetic lock, cylinder lock, economy lock or bathroom lock

GLAZING

- milk or transparent hardened glass fixed in standard or VSG 221 security type of glass, smooth on both sides additionally charged
- possibility to modify glazing for REVERSE (OBVERSE in standard glazing)

AVAILABLE SOLUTIONS (page 86-96)

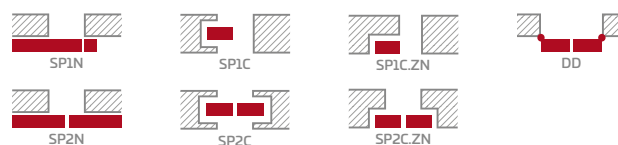

AVAILABLE DOOR WIDTHS



ACCESSORIES CHARGED ADDITIONALLY

ventilation cut

plastic ventilation sleeves (4 pieces)

metal ventilation grill round and square (4 pieces);
finishing: brushed nickel or patina, white and black

ventilation grill
only for door leaves in widths: 80, 90, 100

rebated and non-rebated door leaf 100 wide

VSG 221 security type of glass, smooth on both sides

metal hinge casings for rebated door leaf
colour: brushed nickel, patina, polished chrome, polished brass,
white and black

automatic door seal

GREKO



PREMIUM

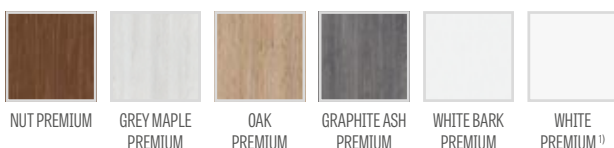

CPL



VENGE CPL

¹⁾ white foil imitating painting surface



FRAGI



REBATED AND NON-REBATED INTERIOR STILE DOOR LEAFS



FRAGI 1
NUT GREKO, DECO door knob



FRAGI 1



FRAGI 2



FRAGI 3



FRAGI 4
DECORMAT



FRAGI 5
TRANSPARENT



FRAGI 7
DECORMAT GRAPHITE



FRAGI 9



FRAGI 10



Presented model: FRAGI 4 in NUT GREKO decor with DECO door knob



CONSTRUCTION

- rebated door leaf made in STILE technology
- MDF rails covered in GREKO or CPL decors and vertical wooden rails covered with thin HDF in PREMIUM decors

HARDWARE

- rebated door leaves: three silver pintle hinges regulated horizontally
- bolt lock for regular key, cylinder, economy lock or bathroom lock

GLAZING

- hardened glass 8 mm thick
- possibility to modify glazing for REVERSE (OBVERSE in standard glazing)

AVAILABLE SOLUTIONS (page 94-96)



AVAILABLE DOOR WIDTHS



ACCESSORIES CHARGED ADDITIONALLY

ventilation cut

metal hinge casings for rebated door leaf
 colour: brushed nickel, patina, polished chrome, polished brass, white and black

GREKO



PREMIUM



CPL



Attention:

Presented graphics of model FRAGI concerns only widths 80. The remaining widths will show little differences in the proportion of graphics. Detailed information can be accessed online at www.erkado.pl

GLAZING IN STANDARD - OBVERSE

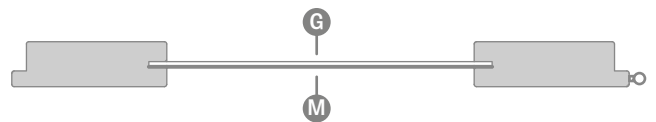

GLAZING ON DEMAND - REVERSE

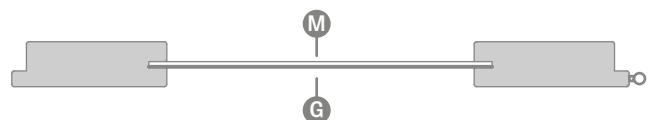

G smooth side; **M** matt decorated side

¹⁾ white foil imitating painting surface



GRAF GLASS DOORS

GLASS INTERIOR DOOR LEAFS



GRAF 5



GRAF 6



GRAF 7



GRAF 8 DECORMAT



GRAF 9 TRANSPARENT



GRAF 11 DECORMAT GRAPHITE



GRAF 12



GRAF 16



GRAF 17



GRAF 18



GRAF 20



GRAF 22

Presented model: GRAF 1 in WHITE GREKO



CONSTRUCTION

- hardened glass 8 mm thick
- possibility to modify glazing for REVERSE (OBVERSE in standard)
- milk glass with decors painted in black or in white

FIXED AND ADJUSTABLE FRAME

- prices of fixed and adjustable frames are the same as for rebated frames
- no possibility to apply electric strike
- **GRAF REBATED FRAMES COME IN ALL AVAILABLE DECORS AS FOR REGULAR REBATED FRAMES**

Attention:

Presented graphics of MODEL GRAF concerns only the Door width 80 cm. The remaining widths in GRAF 1, 5, 7, 12, 16, 18 will show little differences in the proportion of graphics. Detailed information can be accessed online at www.erkado.pl

AVAILABLE DOOR WIDTHS

60 70 80 90 (add. charged)

ACCESSORIES CHARGED ADDITIONALLY

door leaf 90 cm wide

ventilation cut

hardware

HARDWARE METAL-BUD stainless steel

Metal-Bud

Available shapes: oval or rectangular



2A OVAL



3A OVAL



1A OVAL



4AZ OVAL EXTERIOR
4AW OVAL INTERIOR



HINGE OVAL



2B RECTANGULAR



3B RECTANGULAR



1B RECTANGULAR



4BZ RECTANGULAR EXTERIOR
4BW RECTANGULAR INTERIOR



HINGE RECTANGULAR

UNO PREMIUM



REBATED AND NON-REBATED INTERIOR DOOR LEAFS



UNO PREMIUM
OAK PREMIUM, TUPAI 2275 Q door knob

Presented model: UNO PREMIUM in NUT PREMIUM decor with MILANO door knob



Presented model: UNO PREMIUM in OAK PREMIUM decor with TUPAI 2275 Q door knob



Presented model: UNO PREMIUM in DIAGONAL LARCH decor with TUPAI 2275 RT door knob



CONSTRUCTION

- rebated or non-rebated door leaf
- MDF rails covered with two HDF boards
- stabilising filling 'honeycomb core' or homalight board (extra charged)

FINISHING

- HDF board covered with diagonal or premium foil
- door leaf made in standard rebated or non-rebated technology
- edge banding compatible with door leaf colours; optionally rebate can be smooth black in WHITE PREMIUM decor and diagonal black in DIAGONAL ASH PREMIUM decor

HARDWARE

- rebated door leaves: three silver pintle hinges regulated horizontally, bolt lock
- non-rebated door leaves: three hidden hinges regulated in three planes, magnetic lock, cylinder lock, economy lock or bathroom lock

AVAILABLE SOLUTIONS (page 86-96)

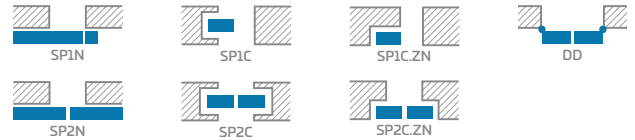

AVAILABLE DOOR WIDTHS



PREMIUM



NUT PREMIUM



GREY MAPLE PREMIUM



OAK PREMIUM



WHITE BARK PREMIUM



GRAPHITE ASH PREMIUM



CONCRETE PREMIUM



DIAGONAL LARCH



WHITE PREMIUM¹⁾

TYPES OF EDGE FINISHING

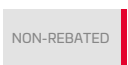

NON-REBATED

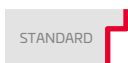

STANDARD



SMOOTH BLACK DOOR EDGE FINISHING



DIAGONAL BLACK DOOR EDGE FINISHING



ACCESSORIES CHARGED ADDITIONALLY

homalight board

enforcement for self-lock

door closer

additional bottom construction bar (offers possibility to individual trim of door leaf up to 8 cm)

metal ventilation grill round and square (4 pieces); finishing: brushed nickel or patina, white and black

plastic ventilation sleeves (4 pieces)

ventilation cut or ventilation grill

rebated and non-rebated door leaf 100 wide

automatic door seal

metal hinge casings for rebated door leaf
colour: brushed nickel, patina, polished chrome, polished brass, white and black

bull eye stainless steel: polished chrome or brushed satin; milk decormat glass, transparent glass,
dimensions: diameter inside: 235 mm, outside: 350 mm

¹⁾ white foil imitating painting surface

UNO PREMIUM



REBATED AND NON-REBATED INTERIOR DOOR LEAFS



UNO PREMIUM
GRAPHITE ASH PREMIUM, TUPAI 2275 RT door knob

Presented model: UNO PREMIUM in GREY MAPLE PREMIUM decor with TUPAI 2275 Q door knob



Presented model: UNO PREMIUM in GRAPHITE ASH PREMIUM decor with TUPAI 2275 RT door knob





PREMIUM



UNO PREMIUM
CONCRETE PREMIUM, TUPAI 2275 Q door knob



Presented model: UNO PREMIUM in WHITE BARK PREMIUM decor with TUPAI 2275 RT door knob



Presented model: UNO PREMIUM in DIAGONAL LARCH decor with TUPAI 2275 RT door knob





UNO LUX



REBATED AND NON-REBATED INTERIOR DOOR LEAFS



UNO LUX
NUT GREKO, TUPAI 2275 Q door knob



UNO LUX 1



UNO LUX 3



UNO LUX 4



UNO LUX 7



UNO LUX 8



UNO LUX 9



Presented model: UNO LUX 4 in VENGE decor with TUPAI 2275 Q door knob



CONSTRUCTION

- rebated or non-rebated door leaf
- MDF rails covered with two HDF boards
- stabilising filling 'honeycomb core'

FINISHING

- HDF board covered with foil or CPL
- door leaf made in SOFT or STANDARD technology
- aluminium profiles 8 mm, in line with door leaf surface on both sides of door leaf.

HARDWARE

- rebated door leaves: two or three (GREKO decors) silver pintle hinges regulated horizontally, bolt lock
- non-rebated door leaves: three hidden hinges regulated in three planes, magnetic lock, cylinder lock, economy lock or bathroom lock

AVAILABLE DOOR WIDTHS

60 70 80 90 100

ACCESSORIES CHARGED ADDITIONALLY

homalight board (the third hinge is applied and included in the price of a door leaf)

enforcement for self-lock

door closer

additional bottom construction bar (offers possibility to individual trim of door leaf up to 8 cm)

plastic ventilation sleeves to room and plain door leaves (to bathroom door leaves when ordered without holes for sleeves)

ventilation cut or ventilation grill (the cut is not possible in models: UNO LUX: 1, 3, 4)

rebated and non-rebated door leaf 100 wide (price includes third default hinge in door leaf)

additional hinge to rebated door leaf (does not concern homalight board, GREKO decors and door leaf 100 cm)

automatic door seal

metal hinge casings for rebated door leaf
colour: brushed nickel, patina, polished chrome, polished brass, white and black

SOFT / STANDARD



STANDARD / CPL



AVAILABLE SOLUTIONS (page 86-96)

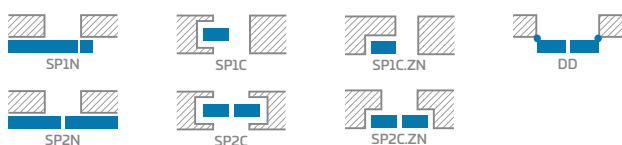

TYPES OF EDGE FINISHING

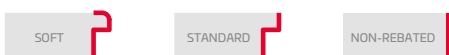

¹⁾ white foil imitating painting surface

²⁾ in SOFT technology the foil is connected on the rebate

³⁾ only STANDARD



BOARD DOORS

REBATED AND NON-REBATED INTERIOR DOOR LEAFS



CLASIC



ROOM

BATHROOM

PLAIN

UNO



ROOM

BATHROOM

PLAIN

FINISHING

- lacquered HDF board
- ATTENTION: the frame (foil) might slightly differ in colour tone with the LAK decors

HARDWARE

- two screw pintle hinges
- lock for regular key, cylinder or bathroom lock

GLAZING

- oak bark glass

AVAILABLE DOOR WIDTHS

60 70 80 90 100 (only WHITE LAK)

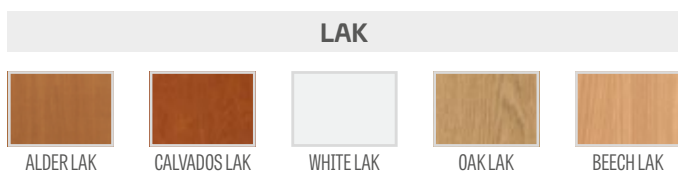

AVAILABLE SOLUTIONS (page 94-96)



TYPES OF EDGE FINISHING

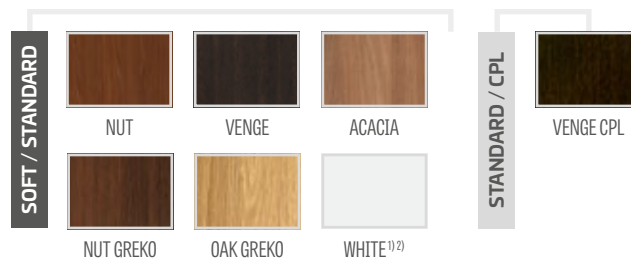
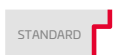

TYPES OF EDGE FINISHING

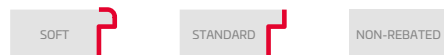

UNO, UNO PREMIUM, CLASIC - ACCESSORIES CHARGED ADDITIONALLY

bull eye stainless steel: polished chrome or brushed satin; milk decormat glass, transparent glass (available only for UNO PLAIN, UNO PREMIUM and CLASIC MODELS)
 dimensions: diameter inside: 235 mm, outside: 350 mm



¹⁾ white foil imitating painting surface

²⁾ in SOFT technology the foil is connected on the rebate



BRAND



ROOM

BATHROOM

PLAIN

ALEJA LUX



ROOM

BATHROOM

PLAIN

DORA



ROOM

BATHROOM

PLAIN

MANHATTAN



ROOM

BATHROOM

PLAIN

EKA

BEST PRICE!



ROOM

BATHROOM

PLAIN

GAMA



ROOM

BATHROOM

PLAIN





BOARD DOORS

REBATED AND NON-REBATED INTERIOR DOOR LEAFS



ALEJA



ROOM

BATHROOM

PLAIN

TOLEDO



ROOM

BATHROOM

PLAIN

ZEFIR

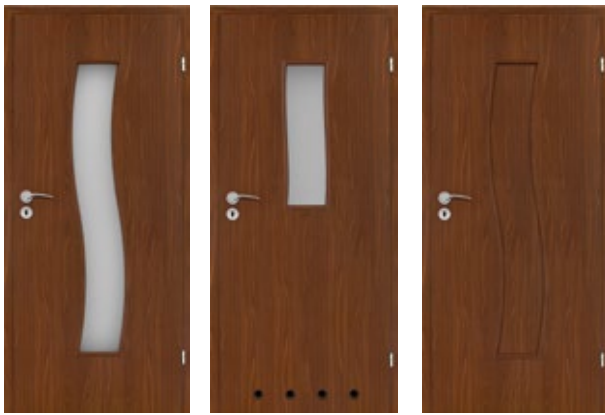

ROOM

BATHROOM

PLAIN

BROADWAY



ROOM

BATHROOM

PLAIN

CORTINA



ROOM

BATHROOM

PLAIN

GALERIA



ROOM

BATHROOM

PLAIN





CONSTRUCTION

- rebated or non-rebated door leaf
- MDF rails covered with two HDF boards
- stabilising filling 'honeycomb core'

FINISHING

- HDF board covered with foil or CPL
- door leaf made in SOFT or STANDARD technology

HARDWARE

- rebated door leaves: two or three (GREKO decors) silver pintle hinges regulated horizontally, bolt lock
- non-rebated door leaves: three hidden hinges regulated in three planes, magnetic lock, cylinder lock, economy lock or bathroom lock

GLAZING

- decormat milk glass
- possibility to modify glazing for REVERSE (OBVERSE in standard glazing)

ACCESSORIES CHARGED ADDITIONALLY

homalight board (the third hinge is applied and included in the price of a door leaf)

enforcement for self-lock

door closer

additional bottom construction bar (offers possibility to individual trim of door leaf up to 8 cm)

plastic ventilation sleeves to room and plain door leaves (to bathroom door leaves when ordered without holes for sleeves)

rebated and non-rebated door leaf 100 wide (the third hinge is applied and included in the price of a door leaf)

additional hinge to rebated door leaf (does not concern homalight board, GREKO decors and door leaf 100 cm)

automatic door seal

metal hinge casings for rebated door leaf
colour: brushed nickel, patina, polished chrome, polished brass, white and black

AVAILABLE SOLUTIONS (page 80-99)

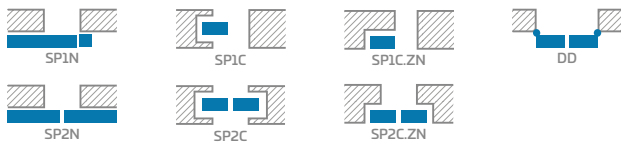

TYPES OF EDGE FINISHING

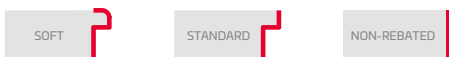

AVAILABLE DOOR WIDTHS

60 70 80 90 100

	SOFT / STANDARD									STANDARD / CPL
	NUT	VENGE	ACACIA	BRIGHT ACACIA	NUT GREKO	SANREMO GREKO	OAK GREKO	MEDIUM OAK GREKO	SONOMA GREKO	VENGE CPL
ALEJA	✓	✓	✓	✓	✓	✓		✓		
ALEJA LUX	✓	✓	✓	✓	✓	✓		✓	✓	
BRAND	✓	✓	✓	✓	✓					
BROADWAY	✓	✓	✓	✓	✓	✓	✓			✓
CORTINA	✓	✓	✓		✓					
DORA	✓	✓	✓	✓	✓	✓	✓			✓
EKA	✓	✓	✓	✓	✓	✓	✓			✓
GALERIA	✓	✓	✓	✓	✓	✓	✓			✓
GAMA	✓	✓	✓		✓					
MANHATTAN	✓	✓	✓	✓	✓	✓	✓			✓
TOLEDO		✓			✓	✓		✓		
ZEFIR	✓	✓	✓							



HERSE SET



ENTRANCE DOOR LEAF WITH ANTI-BURGLARY LOCKS



Presented model: HERSE SET in NUT decor with ESSEN

GENERAL INFORMATION

- HERSE SET door leaf is used in the housing and public utility as the entrance door (excluding door leaf 80N).
- HERSE door leaf together with the fixed frame, stainless steel or hard wood (not painted) threshold or an automatic seal has the insulating power of $R_w = 32\text{dB}$.
- HERSE SET door leaf in GOLD and SILVER SETS are already assembled as one piece and together with installed threshold whereas in GOLD SET they are holes for door knob and upper lock face assembly ready.

CONSTRUCTION

- MDF rails covered with two HDF boards
- special HOMALIGHT board filling
- enforcement with massive iron profile
- thickness 46 mm
- additional gasket

FINISHING

- door leaf made in SOFT, STANDARD or SOFT PCV technology
- HDF board covered with FINISH foil, CPL, PREMIUM, GREKO or PCV TWIN
- doors can be cut up to 8 cm by Erkado

HARDWARE

- three screw 3D regulated pintle hinges
- two three-bolt anti-burglary locks in class RC2 for cylinder (price includes optional change of lower lock only)
- possibility to select only lower latch lock (no change in price) or without three anti-burglary contact bolts on the hinge side if wished

FIXED AND ADJUSTABLE REBATED HERSE DOOR FRAME

- extra charge + 15% to the prices of rebated door frames [no extra charge for forfeiting anti-burglary upper lock and anti-burglary bolts]
- possible application of electric strike in frame for lower lock [what excludes upper lock in a door leaf]
- main plate in frames is regulated

AVAILABLE DOOR WIDTHS

80 90 80N available only in PCV decor and fixed or iron frame

TYPES OF EDGE FINISHING



GOLD SET
SILVER SET

Door leaf with wooden fixed frame, stainless steel threshold and hardware⁴⁾

Door leaf with wooden fixed frame, stainless steel threshold without hardware⁴⁾

ACCESSORIES CHARGED ADDITIONALLY

peep-hole

threshold made of hard wood, with seal, 55 mm thick or stainless steel threshold with seal

threshold made of hard wood to adjustable frame

door closer

enforcement for self-lock

automatic door seal

trimming door leaf (door leaf and frame) up to 8 cm trimmed by 1 cm

cylinder 30/45

cylinder-holder 30G/45 or 30/45G

cylinder 30/45 and cylinder-holder 30G/45 or 30/45G in one-key system

metal hinge casings (nickel satin, patina)

ESSEN door knob (nickel satin)

ESSEN knob face (nickel satin)

¹⁾ white foil imitating painting surface

²⁾ in SOFT technology the foil is connected on the rebate

³⁾ only STANDARD edge

⁴⁾ hardware set: ESSEN door knob nickel satin, upper lock plate, cylinders in 1-key system (upper with knob), peep-hole (without drilled hole)

SOFT, STANDARD

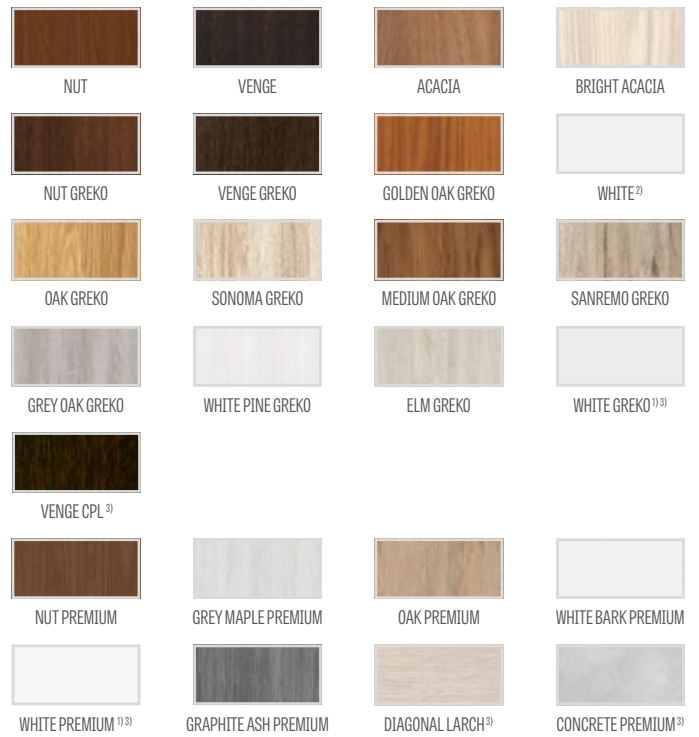

SOFT PCV



HERSE SET
OAK PREMIUM, ESSEN door knob



HERSE LUX SET



ENTRANCE DOOR LEAF WITH ANTI-BURGLARY LOCKS

Presented model: HERSE LUX SET 4 in NUT GREKO decor with ESSEN



GENERAL INFORMATION

- HERSE LUX SET door leaf is used in the housing and public utility as the entrance door (excluding door leaf 80N).
- HERSE door leaf together with the fixed frame, stainless steel or hard wood (not painted) threshold or an automatic seal has the insulating power of $R_w = 32\text{dB}$.
- HERSE LUX SET door leaf in GOLD and SILVER SETS are already assembled as one piece and together with installed threshold whereas in GOLD SET they are holes for door knob and upper lock face assembly ready.

CONSTRUCTION

- MDF rails covered with two HDF boards
- special HOMALIGHT board filling
- enforcement with massive iron profile
- thickness 46 mm
- additional gasket

FINISHING

- door leaf made in SOFT, STANDARD or SOFT PCV technology
- HDF board covered with FINISH foil, CPL, PREMIUM, GREKO or PCV TWIN
- doors can be cut up to 8 cm by Erkado
- aluminium profiles (8 mm) on both sides of door leaf

HARDWARE

- three screw 3D regulated pintle hinges
- two three-bolt anti-burglary locks in class RC2 for cylinder (price includes optional change of lower lock only)
- possibility to select only lower latch lock (no change in price) or without three anti-burglary contact bolts on the hinge side if wished

FIXED AND ADJUSTABLE REBATED HERSE DOOR FRAME

- extra charge + 15% to the prices of rebated door frames [no extra charge for forfeiting anti-burglary upper lock and anti-burglary bolts]
- possible application of electric strike in frame for lower lock [what excludes upper lock in a door leaf]
- main plate in frames is regulated

AVAILABLE DOOR WIDTHS

80 90 80N available only in PCV decor and fixed or iron frame

TYPES OF EDGE FINISHING



PAKIET GOLD Door leaf with wooden fixed frame, stainless steel threshold and hardware ⁴⁾

PAKIET SILVER Door leaf with wooden fixed frame, stainless steel threshold without hardware ⁴⁾

ACCESSORIES CHARGED ADDITIONALLY

peep-hole

threshold made of hard wood, with seal, 55 mm thick or stainless steel threshold with seal

threshold made of hard wood to adjustable frame

samozamykacz ramieniowy

enforcement for self-lock

automatic door seal

trimming door leaf (door leaf and frame) up to 8 cm trimmed by 1 cm

cylinder 30/45

cylinder-holder 30G/45 or 30/45G

cylinder 30/45 and cylinder-holder 30G/45 or 30/45G in one-key system

metal hinge casings (nickel satin, patina)

ESSEN door knob (nickel satin)

ESSEN knob face (nickel satin)

¹⁾ white foil imitating painting surface

²⁾ in SOFT technology the foil is connected on the rebate

³⁾ only STANDARD edge

⁴⁾ hardware set: ESSEN door knob nickel satin, upper lock plate, cylinders in 1-key system (upper with knob), peep-hole (without drilled hole)

SOFT, STANDARD

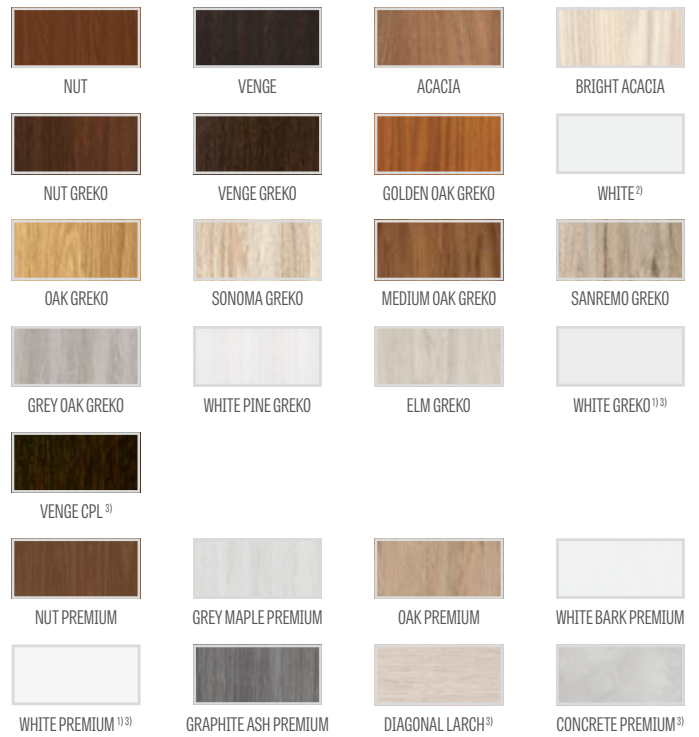

SOFT PCV



HERSE LUX SET 1



HERSE LUX SET 3



HERSE LUX SET 4



HERSE LUX SET 10



HERSE LUX SET 11

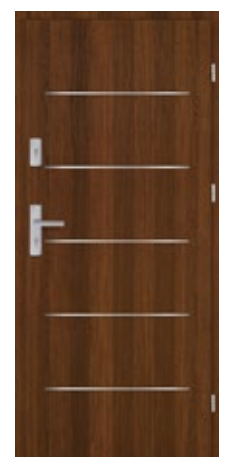

HERSE LUX SET 12

HERSE MAX SET



ENTRANCE DOOR LEAF WITH ANTI-BURGLARY LOCKS

Presented model: HERSE MAX SET 1 in GOLDEN OAK TWIN decor with ESSEN



GENERAL INFORMATION

- HERSE SET door leaf is used in the housing and public utility as the entrance door (excluding door leaf 80N).
- HERSE door leaf together with the fixed frame, stainless steel or hard wood (not painted) threshold or an automatic seal has the insulating power of $R_w = 32\text{dB}$.
- HERSE MAX SET door leaf in GOLD and SILVER SETS are already assembled as one piece and together with installed threshold whereas in GOLD SET they are holes for door knob and upper lock face assembly ready.

CONSTRUCTION

- MDF rails covered with two HDF boards
- special HOMALIGHT board filling
- enforcement with massive iron profile
- thickness 46 mm
- additional gasket

FINISHING

- door leaf made in SOFT PCV technology
- milled HDF covered with PCV TWIN decor
- milling details are presented at page 85
- doors can be cut up to 8 cm by Erkado

HARDWARE

- three screw 3D regulated pintle hinges
- two three-bolt anti-burglary locks in class RC2 for cylinder (price includes optional change of lower lock only)
- possibility to select only lower latch lock (no change in price) or without three anti-burglary contact bolts on the hinge side if wished

FIXED AND ADJUSTABLE REBATED HERSE DOOR FRAME

- extra charge + 15% to the prices of rebated door frames [no extra charge for forfeiting anti-burglary upper lock and anti-burglary bolts]
- possible application of electric strike in frame for lower lock [what excludes upper lock in a door leaf]
- main plate in frames is regulated

SOFT PCV



VENGE TWIN



GOLDEN OAK TWIN

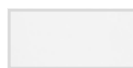

WHITE TWIN ¹⁾



MIDDLE NUT TWIN

TYPES OF EDGE FINISHING



PAKIET GOLD Door leaf with wooden fixed frame, stainless steel threshold and hardware ⁴⁾

PAKIET SILVER Door leaf with wooden fixed frame, stainless steel threshold without hardware ⁴⁾

AVAILABLE DOOR WIDTHS

80 90 80N available only in fixed or iron frame

¹⁾ white foil imitating painting surface

⁴⁾ hardware set: ESSEN door knob nickel satin, upper lock plate, cylinders in 1-key system (upper with knob), peep-hole (without drilled hole) otworu

ACCESSORIES CHARGED ADDITIONALLY

peep-hole

threshold made of hard wood, with seal, 55 mm thick or stainless steel threshold with seal

threshold made of hard wood to adjustable frame

door closer

enforcement for self-lock

automatic door seal

trimming door leaf (door leaf and frame) up to 8 cm trimmed by 1 cm

cylinder 30/45

cylinder-holder 30G/45 or 30/45G

cylinder 30/45 and cylinder-holder 30G/45 or 30/45G in one-key system

metal hinge casings (nickel satin, patina)

ESSEN door knob (nickel satin)

ESSEN knob face (nickel satin)



HERSE MAX SET 1



HERSE MAX SET 2



HERSE MAX SET 3



HERSE MAX SET 6

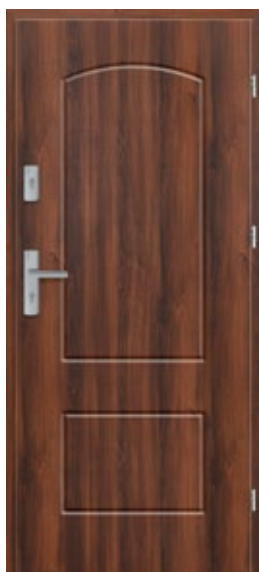

HERSE MAX SET 7

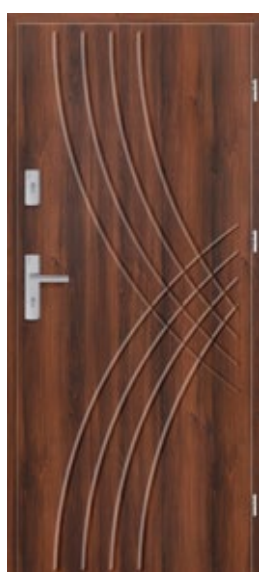

HERSE MAX SET 13



HERSE MAX SET 14

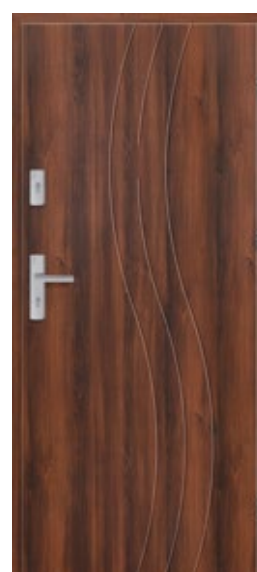

HERSE MAX SET 22



FIXED AND ADJUSTABLE FRAME

HERSE SET, HERSE LUX SET, HERSE MAX SET

TECHNICAL PICTURE OF HERSE FIXED FRAME

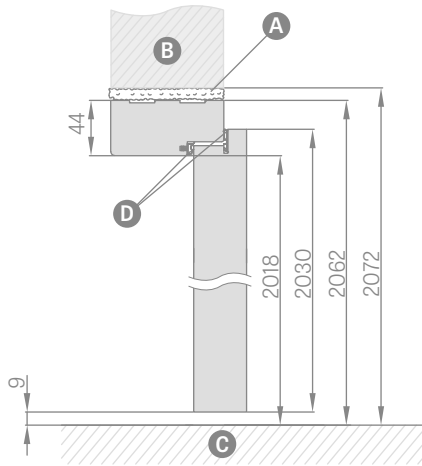

TECHNICAL PICTURE OF HERSE ADJUSTABLE FRAME

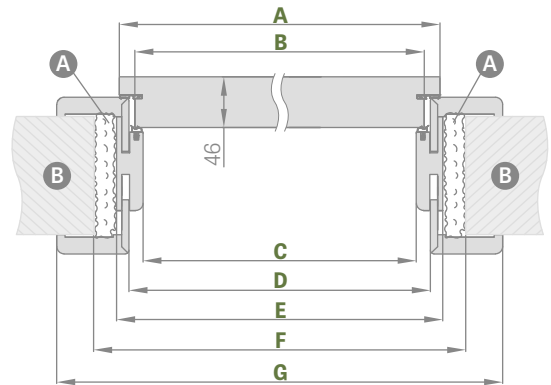
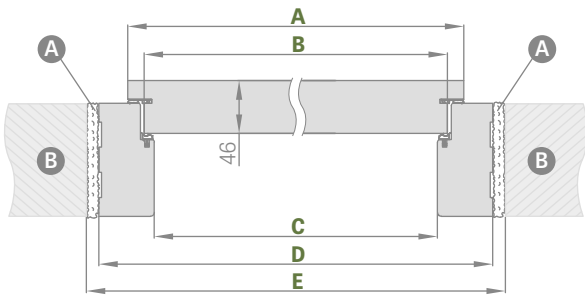
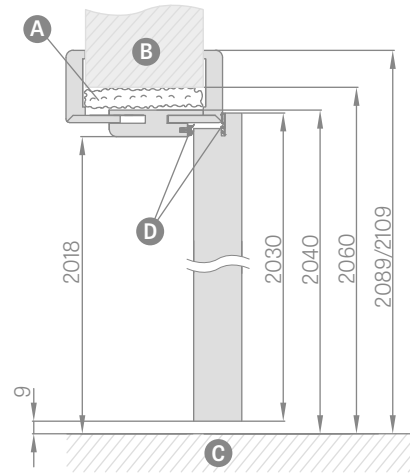

Width of door leaf	A	B	C	D	E
„80N“	804	777	764	852	872
„80“	844	817	804	892	912
„90“	944	917	904	992	1012

Width of door leaf	A	B	C	D	E	F	G
„80“	846	820	804	826	848	888	946*/986**
„90“	946	920	904	926	948	988	1046*/1086**

* adjustable cover with 60 masking trim /
 ** adjustable cover with 80 masking trim

- A** – mounting foam
- B** – wall
- C** – floor
- D** – rubber seal

FIXED AND ADJUSTABLE FRAME

Adjustment scope min.-max (mm)	
1 element	80-100
	100-120
	120-140
	140-160
	160-180
	180-200
	200-220
	220-240
	240-260
	260-280
2 elements	260-300
	280-300
	300-320
	320-340
	340-360
3 elements	360-380
	380-400
	400-420

RANGE OF ADJUSTABLE FRAME

Adj. cover list 6 cm / Adj. cover list 8 cm

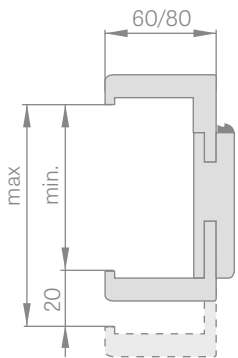

FIXED FRAME

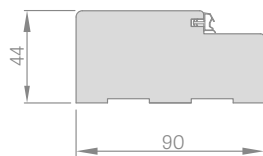

MASKING TRIM

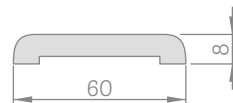

QUARTER ROUND

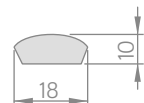

- Connecting the adjustable frame to an angle of 90 degrees is possible only with the list cover 8 cm thick.
- Electric strike



METAL FRAMES

HERSE SET, HERSE LUX SET, HERSE MAX SET

METAL FIXED FRAME CASING TYPE TO HERSE SET

welded and painted in RAL 9010, 9016, 8003, 8017, 7016, 7047, 1001

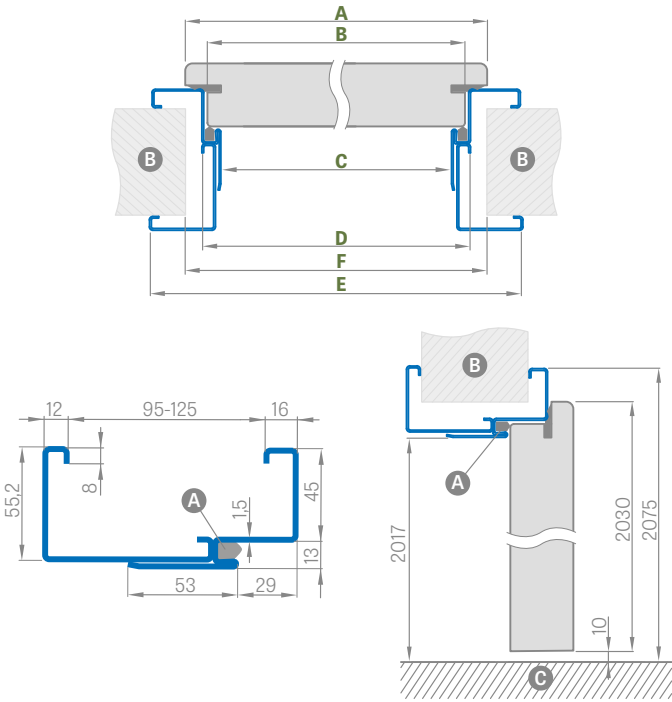

Width of door leaf	A	B	C	D	E	F
„80N”	804	777	761	787	877	855
„80”	844	817	801	827	917	895
„90”	944	917	901	927	1017	995

Adjustment range min.-max (mm)
95-125
125-155
155-185
185-215
215-245
245-275
275-305

RAL



METAL SQUARE FRAME, LARGE SIZE TO HERSE SET

welded and painted in RAL 9010, 9016, 8003, 8017, 7016, 7047, 1001

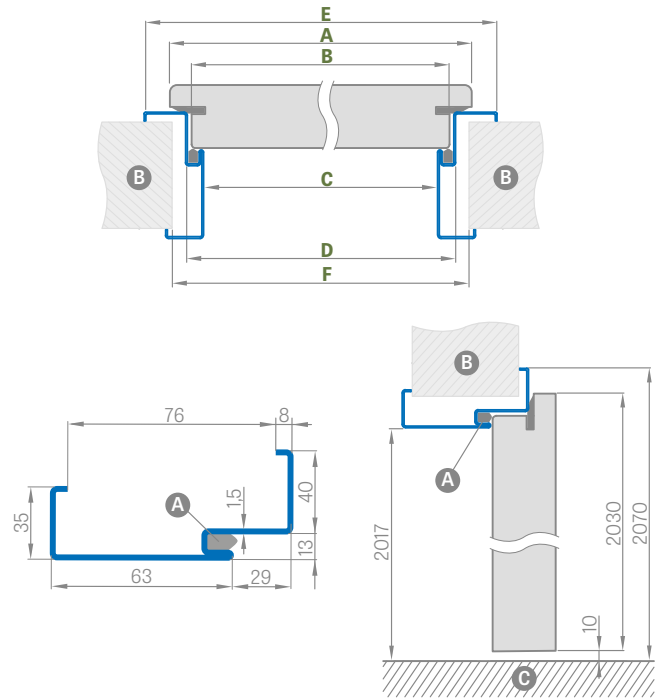

Width of door leaf	A	B	C	D	E	F
„80N”	804	777	761	787	867	843
„80”	844	817	801	827	907	883
„90”	944	917	901	927	1007	983

LAUNCHING EDGE FRAME

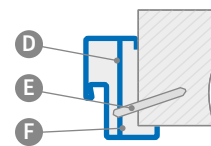

- A** – rubber seal
- B** – wall
- C** – floor
- D** – assembly anchor
- E** – expansion bolt
- F** – filler

ADDITIONAL CHARGES

electric strike

enforcement for self-lock

threshold made of stainless steel

finishing with galvanised steel

LEDA EI30, EI60



INTERIOR FIRE PROTECTION ENTRANCE DOOR MADE IN HALSPAN TECHNOLOGY

Presented model: LEDA EI30 in NUT decor with STANDARD INOX



32dB

GREKO

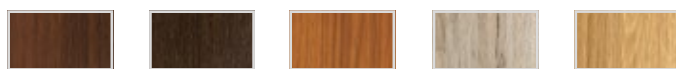

NUT GREKO

VENGE GREKO

GOLDEN OAK GREKO

SANREMO GREKO

OAK GREKO

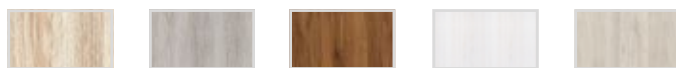

SONOMA GREKO

GREY OAK GREKO

MEDIUM OAK GREKO

WHITE PINE GREKO

ELM GREKO

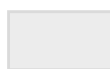

WHITE GREKO¹⁾

FINISH



NUT

VENGE

ACACIA

BRIGHT ACACIA

WHITE¹⁾

CPL



VENGE CPL

PREMIUM



NUT PREMIUM

GREY MAPLE PREMIUM

OAK PREMIUM

WHITE BARK PREMIUM

WHITE PREMIUM¹⁾



MODRZEW POPRZECZNY

GRAPHITE ASH PREMIUM

CONCRETE PREMIUM

¹⁾ white foil imitating painting surface

LEDA EI30

LEDA EI60

GENERAL INFORMATION

The proper performance of the functions such as fire protection, intumescent and acoustic are provided only when assembling the whole set. The complete set includes: fire protection door leaf (pre-equipped with gaskets, locks, hinges, falling gasket) frame, overhead doorcloser and door lock cylinder and door handle all accordant to Polish Norm.

Acoustic isolation of HALSPAN door leaf together with falling gasket according to

PN-B-02151-03:1999 is $R_w=32dB$

Leda door leaf is sold only in a set with leda door frame, wooden or steel

CONSTRUCTION

- dedicated HALSPAN filling respectively 44 mm thick for type EI30 and 54 mm for type EI60
- total thickness of door leaf respectively 50 mm for EI30 and 60 mm for EI60
- conifer frame
- fire resistant and intumescent expanding seal
- automatic seal

FINISHING

- door leaf edge made in STANDARD technology

HARDWARE

- four hinges, Ø18 regulated in three planes
- door lock cylinder
- door closer (add. charged)

OŚCIEŻNICE

- wooden fire protection fixed frame
- fire resistant seal
- electric strike or strike plate with regulation
- metal adjustable square frame of large size or welded and painted in RAL 9010, 9016, 8003, 8017, 7016, 7047, 1001

ACCESSORIES CHARGED ADDITIONALLY

fire resistant door closer.

fire resistant ventilation grill

SAFE INOX knob lub STANDARD INOX knob, page 76

lower lock plate

cylinder 30/40 (EI30) or 30/50 (EI60)

fire resistant upper lock

fire resistant peep-hole



WOODEN FRAME

LEDA EI30, EI60

FIXED WOODEN FRAME TO LEDA EI30 AND EI60

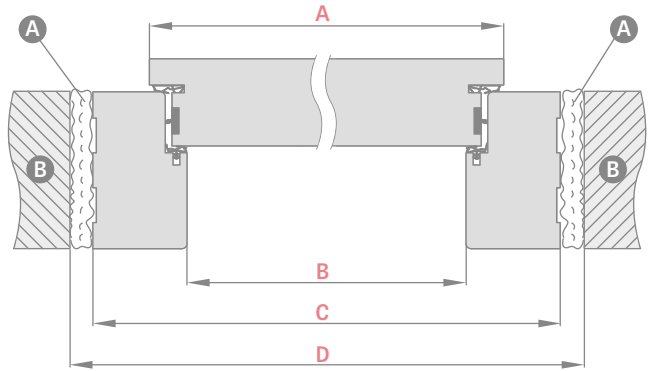
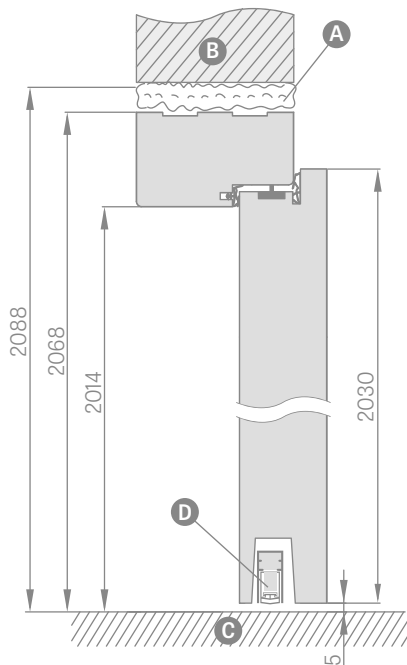

Width of door leaf	A	B	C	D
„80“	860	817	925	955
„90“	960	917	1025	1055
„100“	1060	1017	1125	1155

GENERAL INFORMATION

Wooden fire protection frame used for LEDA EI30 and LEDA EI60 is made in HALSPAN technology

CONSTRUCTION

Fixed frame is made of conifer ply in door leaf colour and has fire protection seal

HARDWARE

- four hinges ø18 regulated in three planes
- electric strike or strike plate with regulation

ADDITIONAL CHARGES

fire resistant electric strike

wall mounting within range from 90 to 450 mm, every 40 mm

double doors

- **A** – fire resistant mounting foam
- **B** – wall **C** – floor **D** – automatic door seal

ELECTRIC STRIKE



DOOR CLOSER



INTERSECTION OF WALL-MOUNTED FIRE RESISTANT DOOR FRAME

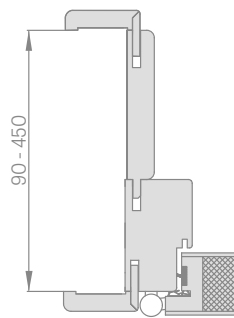

INTERSECTION OF FIXED FIRE RESISTANT DOOR FRAME

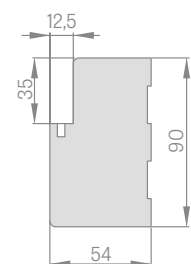



METAL DOOR FRAMES

LEDA EI30, EI60

GENERAL INFORMATION

Wooden fire protection frame used for LEDA EI30 and LEDA EI60 is made in HALSPAN technology

CONSTRUCTION

Fixed frame is made of black steel 1.5 mm thick painted RAL, corner welded and with fire protection seal and enforcement for self-lock in standard.

HARDWARE

- four hinges regulated in two planes
- strike plate or electric strike (add. charged)

METAL SQUARE FRAME, LARGE SIZE, FIRE PROTECTION

welded and painted in RAL 9010, 9016, 8003, 8017, 7016, 7047, 1001

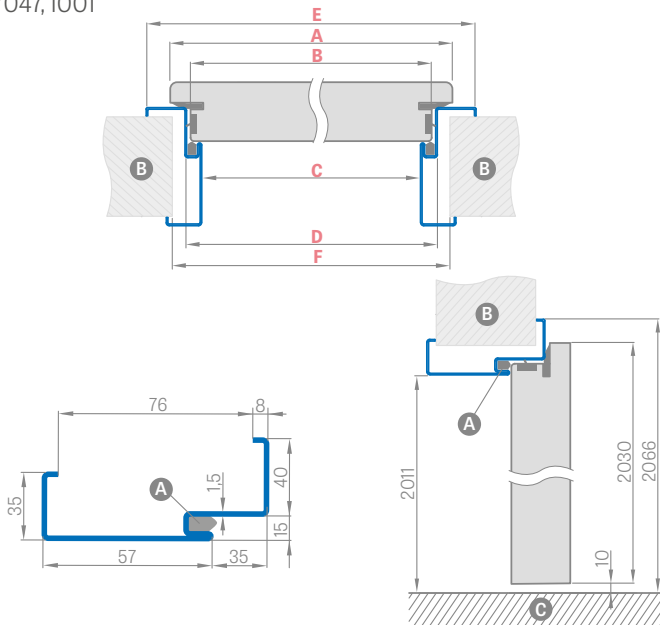

Width of door leaf	A	B	C	D	E	F
„80”	860	834	813	843	923	895
„90”	960	934	913	943	1023	995
„100”	1060	1034	1013	1043	1123	1095

LAUNCHING FRAME INSIDE WALL

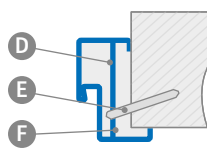

- A** - rubber seal
- B** - wall
- C** - floor
- D** - assembly anchor
- E** - expansion bolt
- F** - filler

ADDITIONAL CHARGES

fire resistant electric strike	
adjustable frame „100”	
fixed frame „100”	
finishing with galvanised steel	+10%
double doors frame	individual quotation

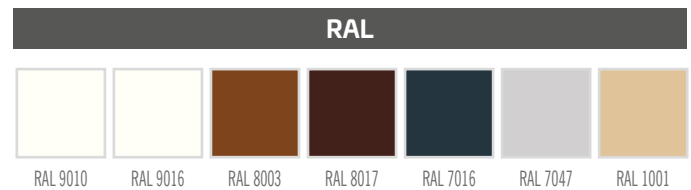

FIRE PROTECTION METAL ADJUSTABLE FRAME CASING TYPE

welded and painted in RAL9010, 9016, 8003, 8017, 7016, 7047, 1001

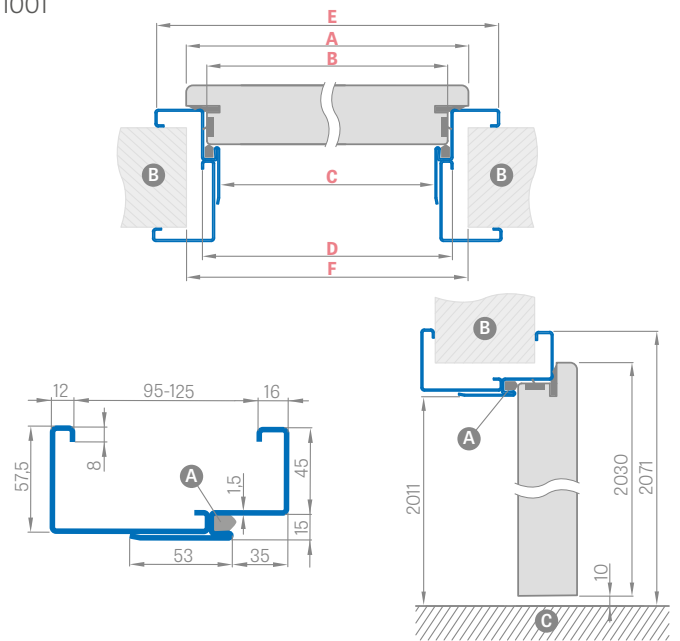

Width of door leaf	A	B	C	D	E	F
„80”	860	834	813	843	933	910
„90”	960	934	913	943	1033	1010
„100”	1060	1034	1013	1043	1133	1110

Adjustment range min.-max (mm)
95-125
125-155
155-185
185-215
215-245
245-275
275-305

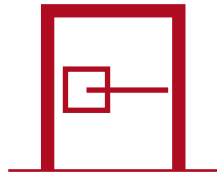

HARDWARE

DOOR KNOBS TO BOARD and STILE DOORS

The knobs must not be applied with board doors together with frame casing, see page 107

structural DECO door knob chrome gloss, nickel satin

Metal-Bud

PRODUCENT KLAMEK



MEDIUM OAK GREKO decor



BLACK decor



WHITE GREKO decor



SONOMA GREKO decor



NUT GREKO decor



OAK GREKO decor



SANREMO GREKO decor

BOLZANO knobs chrome gloss, nickel satin, graphite/chrome

MILANO knobs chrome gloss, nickel satin, graphite/chrome



chrome gloss



graphite/chrome



chrome gloss



graphite/chrome



nickel satin



nickel satin

LOCK PLATE chrome gloss, nickel satin, graphite/chrome to **DECO, BOLZANO** and **MILANO** models



DOOR KNOBS TO BOARD and STILE DOORS

The knobs must not be applied with board doors together with frame casing, see page 107

DUO knobs nickel satin, graphite/chrome

NEW



nickel satin



graphite/chrome

TREND knobs nickel satin, graphite/chrome, chrome gloss

NEW



nickel satin



graphite/chrome



chrome gloss

LOCK PLATE nickel satin, graphite/chrome, chrome gloss to DUO and TREND models



CUBE knobs chrome gloss, brushed chrome mat, black matt

NEW

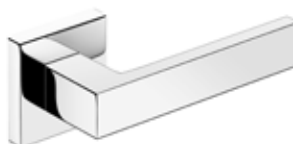

chrome gloss



brushed chrome mat



black matt



DOOR KNOBS TO BOARD and STILE DOORS

The knobs must not be applied with board doors together with frame casing, see page 107

STAINLESS STEEL ERKADO knobs



FUTURA INOX knob



PREMIUM INOX knob



SYSTEM INOX knob



cylinder lock plate



key lock plate



bathroom lock plate



STANDARD INOX knob



SAFE INOX knob



METRO INOX knob



cylinder lock plate



key lock plate



bathroom lock plate

ERKADO knob black matt



FUTURA knob in black matt



cylinder lock plate



key lock plate



bathroom lock plate

KNOBS TO HERSE SET, HERSE LUX SET, HERSE MAX SET

ERKADO BONN i ESSEN knobs



inox plus

BONN knob and plate



patina

BONN knob and plate



black

BONN knob and plate



nickel satin

ESSEN knob and plate



patina

ESSEN knob and plate

DOOR KNOBS TO BOARD and STILE DOORS

The knobs must not be applied with board doors together with frame casing, see page 107

TUPAI 2275 Q knobs brushed chrome, chrome gloss, black

TUPAI



chrome gloss



brushed chrome



black



TUPAI 2275 RT knobs chrome gloss, brushed chrome, black



chrome gloss



brushed chrome



black



Q PRIMULA knobs chrome gloss, brushed chrome, black

NEW



chrome gloss



brushed chrome



black



DOOR KNOBS TO BOARD and STILE DOORS

The knobs must not be applied with board doors together with frame casing, see page 107

GAMET knobs chrome gloss, brushed nickel, antique brass



MISTICO knob
chrome gloss



MISTICO knob
brushed nickel



ERBA knob
brushed nickel



ERBA knob
antique brass



CASCADA knob
brushed nickel



CASCADA knob
antique brass



ASTRA knobs nickel, patina – we recommend to apply it to board doors together with casing frame, page 107

Metal-Bud

PRODUCENT KLAMEK



ASTRA nickel knob
key lock plate



ASTRA nickel knob
bathroom lock plate



ASTRA nickel knob
cylinder lock plate



ASTRA nickel knob
plate



ASTRA patina knob
key lock plate



ASTRA patina knob
bathroom lock plate



ASTRA patina knob
cylinder lock plate



ASTRA patina knob
plate

DOOR KNOBS TO BOARD and STILE DOORS

The knobs must not be applied with board doors together with frame casing, see page 107

SIGMA knobs black matt, white mat

AVAILABLE ONLY AT ERKADO



SIGMA
black matt



SIGMA
white matt



HOPPE DUBLIN knobs



F1 natural aluminium



F94 satin chrome



F249 chrome gloss



CYLINDERS



cylinder
nickel satine colour



cylinder with knob nickel
satine colour

CYLINDER	CYLINDER WITH KNOB
size	size
26/36	G30/40
30/30	G40/30
30/45	G30/50
30/50	G50/30
	30/45G
	30G/45

Cylinders 30/45 + 30G/45, one-key system,
doors opening outside

Cylinders 30/45 + 30G/45, one-key system,
doors opening inside



TECHNICAL INFORMATION

DIRECTIONS OF OPENING

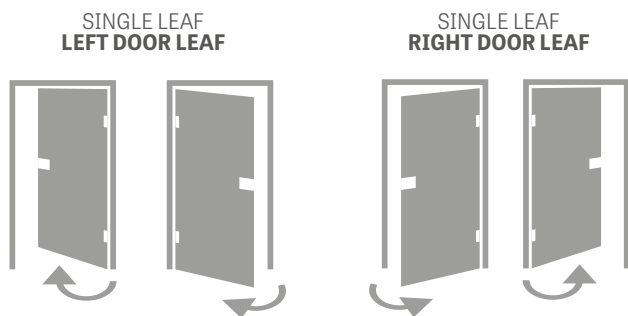

REBATED OR NON-REBATED DOORS

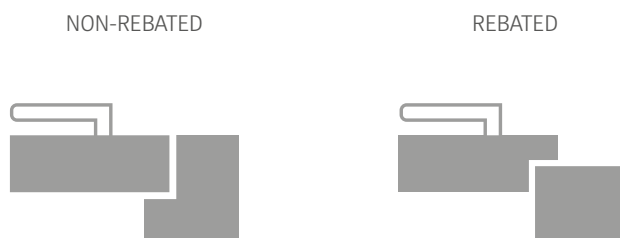

DOUBLE DOORS

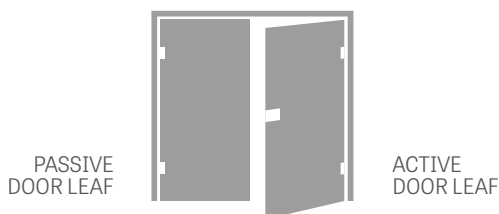

FRAME CORNER CONNECTION



PROPER SELECTION OF CYLINDER

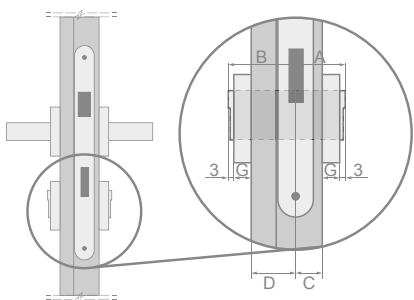

Exemplary calculation of the proper size of cylinder for board and stile door leaves (40 mm) with the thickness of face $G = 7$ mm

$$A/B = (C+G+3) / (D+G+3)$$

$$A/B = (15+7+3) / (25+7+3)$$

$$A/B = 25/35$$

PROPER CALCULATION OF DOOR SET

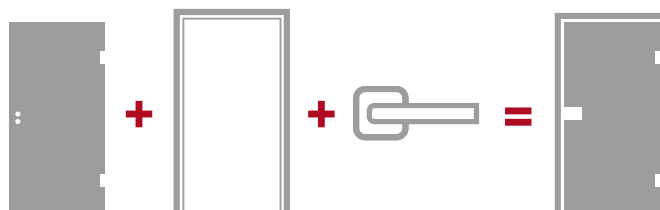

AVAILABLE SOLUTIONS (page 86-96)

- single on-wall sliding system
- double on-wall sliding system
- single in-wall sliding system
- single on-wall sliding system to wall mounting
- single on-wall sliding system to wall mounting
- double on-wall sliding system to wall mounting
- double doors

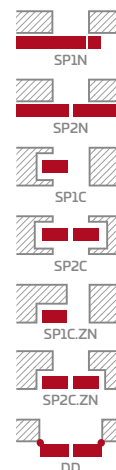

Door type	Door leaf thickness	Lock proportions (c/d)	Recommended cylinder size (a/b)*
board, stile (rebated)	40 mm	15/25	26/36
board, stile (non-rebated)	40 mm	20/20	30/30
HERSE	46 mm	15/31	30/45
LEDA EI 30	50 mm	19/31	30/40
LEDA EI 60	60 mm	19/41	30/50

* Recommended cylinder size for the lock plate 7 mm thick and distance 2-4 mm

TYPES OF DECORS

GREKO

GREKO decor is manufactured on the basis of Japanese base coat of high density. The base is not resined. Thanks to lack of varnish, the foil becomes ecological and is safe for the health and the environment, not only during the production process but also during exploitation and recycling. The foil does not contain formaldehyde and the harmful substances.

Pre-impregnated foil, is printed and protected with the lacquer and coatings of desired parameters. The application of improved finishing layers results in the increase of better surface resistance and flexibility of the product itself. The presence of silicone makes the foils much more resistant to water.

What makes GREKO foil so unique is the unusual, stunning design. High quality of the surface goes together with the 3-D effect of natural wood. These decors bring to mind the natural structure of wood.

PREMIUM

The product on the basis of polypropylene (PP) i.e. the material of high resistance to scratches and friction, providing equally great visual values. This material gives a door leaf noble looks and ensures an individual profile. At the same, it faithfully reflects the structure of natural wood.

The PREMIUM material convinces both with its design and functionality. It is equally resistant to friction, fire resistant and durable.

All products from PREMIUM line guarantee long-term usage including even hard exploitation conditions without any inconveniences.

CPL

CPL laminate is composed of decorative layer impregnated in resin and the base layer providing flexibility. After laminating process, upper surface (resin) becomes hardened and it results in being impressively strong and resistant to friction and scratches. Also, it is characterized by high intolerance to high temperature and UV radiation.

Applying CPL laminate allows to exploit doors in so called tough spaces [being exposed to extreme conditions, humidity and over regular exploitation. The laminate is 0.2 mm thick.

TYPES OF EDGE FINISHING

SOFT EDGE

A door leaf made with soft edge finishing is free of sharp edges and that makes it look aesthetic and modern. The applied decors are more resistant to scratches and this improves general condition of the door leaf and its exploitation.

SOFT door leaf is equipped with additional vertical bars what improves greatly the stability of the whole construction; it is of significant importance in models with rich glazing.

The foils applied to SOFT edge is connected in two spots shown in the picture below (not applicable for the white decor as the foil is connected on the rebate).



STANDARD EDGE

A door leaf with this type of edge finishing is of straight edge. The surface material joins with the rebate material on the very edge of the rebate. This is illustrated by the picture below.

The exact manner of joining the material is applied to non-rebated door leaves, in general, and for sliding systems.

The flat surface is covered with the CPL laminate 0.2 mm thick, polypropylene PREMIUM foil, GREKO finish foil or LAK [lacquered HDF]

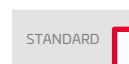

SOFT PCV

The finishing applied here is mainly used for the production of entrance interior doors - HERSE collection.

SOFT PCV is based on high pressure application of the PCV material 0.7 mm thick on the flat or milled surface, together with the rebate. The joining of the material is in the invisible place. PCV material applied on the door leaf results in creating a unique and hard surface resistant to scratches, extreme temperature, humidity and detergents.



STILE DOOR LEAF

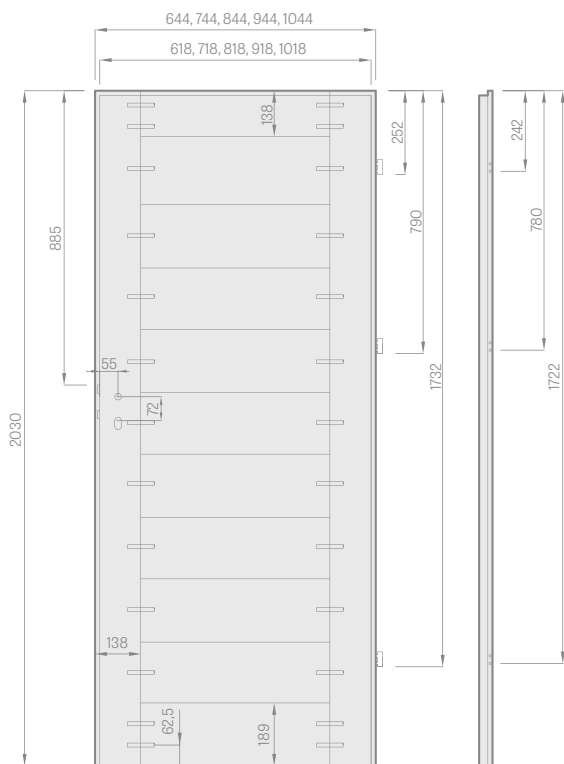

rebated door leaf



- A** MDF or wooden rails in PREMIUM decor
- B** MDF bars



Solid rail 22 mm thick



Esthetic profiled non-rail glazing



MDF rail for GREKO and CPL foils



Wooden rail for PREMIUM foil
- core made of layer plywood

BOARD DOOR LEAF

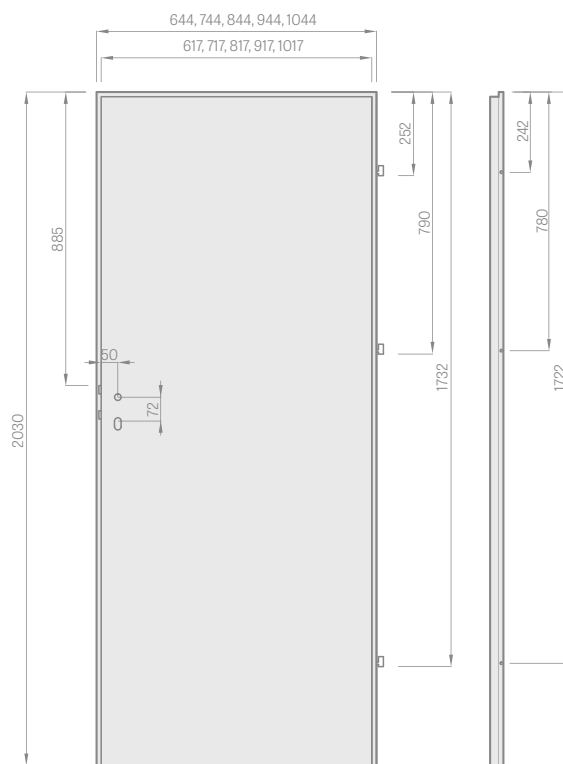

rebated door leaf

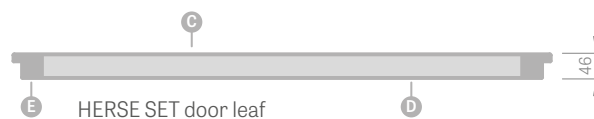

HERSE SET door leaf

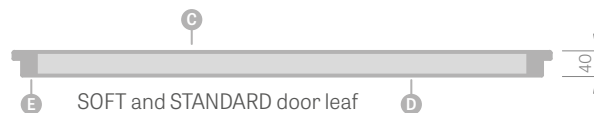

SOFT and STANDARD door leaf



REBATED door leaf

- A** MDF board; **C** HDF board; **D** filling;
- E** MDF or wooden rails for HERSE SET and UNO PREMIUM

TYPES OF FILLINGS

honeycomb core



homalight board



Honeycomb core and homalight board fillings come only with board doors.

Erkado applies mandatorily third hinge with homalight board.

GRAF GLASS PANE

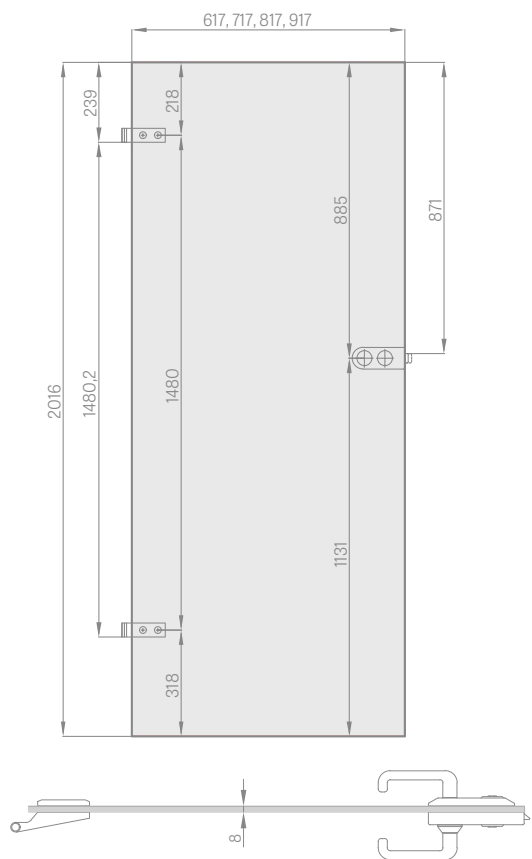

LEDA DOOR LEAF

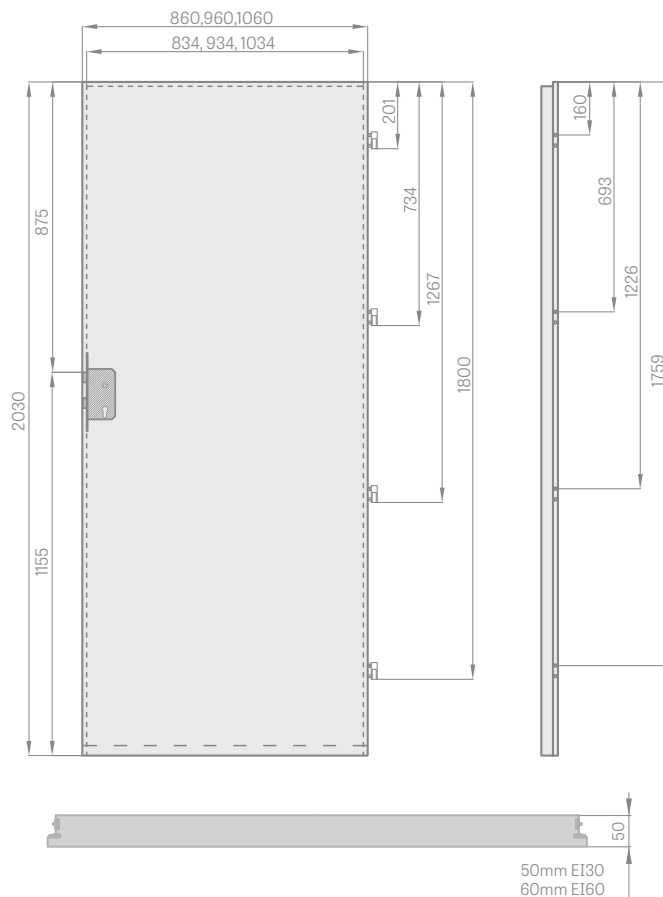

BATHROOM LOCK

exterior side (Z)

interior side (W)

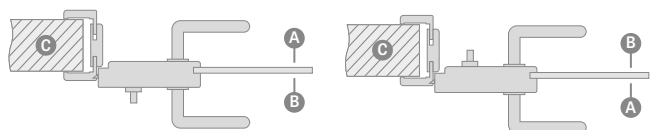

A hall; B bathroom; C wall

Bathroom lock – when ordering bathroom lock, the following should be selected:

exterior lock – when blocking is to be fixed on the exterior side of the door (Z)

or

interior lock – when blocking is to be fixed on the interior side of the door (W).

Attention: bathroom locks are either left or right

STANDARD GLAZING 'OBSERVE'



GLAZING ON DEMAND 'REVERSE'



G smooth side; M matt decorated side



Dedicated HALSPAN filling
44 mm [EI30] /
54 mm [EI60]



Fire resistant and
intumescent expanding seal



Automatic door seal



Three practical hinges with
3D regulation



Fixed frame

METAL HINGE CASINGS



brushed nickel, patina, chrome gloss, brass gloss, white and black

Casing dimensions:

- internal diameter 16 mm for HERSE SET
- internal diameter 15 mm for board and STILE doors.
- length 47 mm

Ventilation cut and ventilation sleeves

Ventilation cut is not available for non-rebated door leaves to on-wall and in-wall sliding systems.

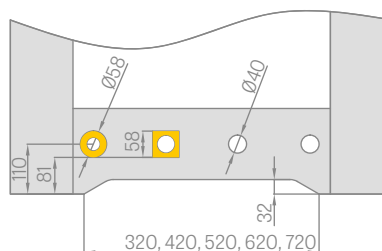

VENTILATION



Plastic ventilation sleeves to board doors



Plastic ventilation sleeves to STILE, TWIN and UNO PREMIUM door leaves



Square and round metal ventilation sleeves to STILE, TWIN and UNO PREMIUM door leaves



Ventilation grills

TRIMMING DOOR LEAFS

It is possible to trim the door leaf in Polish Norm, individually, up to max 50 mm or 80 mm in HERSE SET doors (if not already trimmed in the factory) or in board doors leaves only if an additional bottom bar was fixed.

(ATTENTION: the following must not be trimmed: FRAGI, double doors, LEDA, non-rebated door leaves to sliding systems, GRAF glass doors and any STILE door leaf in Czech Norm.

STANDARD GLAZING 'OBVERSE'

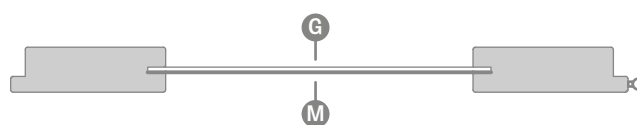

GLAZING ON DEMAND 'REVERSE'

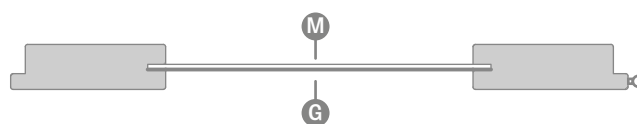

G smooth side; M matt decorated side

GLUED GLASS VSG 221, 331, 441 MILK GLASS

to STILE door leaves

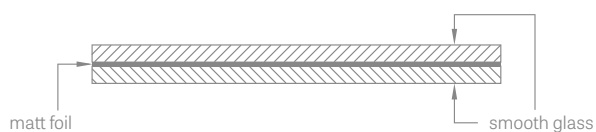

CLEANING KIT FOR REGENERATING AND MAINTAINING DOOR SURFACES BY OTTIMO



2 x 250 ml

ELECTRIC STRIKE

(available for fixed and adjustable frame to rebated door leaves, however not available for the GRAF glass frames)



Types of electric strikes:

- basic 12 V
- basic 24 V
- with switch-off 12 V
- with switch-off 24 V
- reverse 12 V
- reverse 24 V

BASIC

WITH THE SWITCH

REVERSE

- closed all the time, opens when voltage is on
- works as the basic one but has possibility to be switched off
- supplying voltage causes closing, lack of voltage opening

HARDWARE

BOLT LOCKS

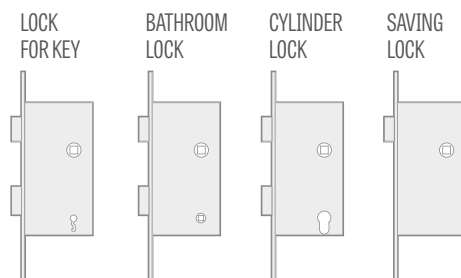

FIXING FRAME TO NON-REBATED DOOR LEAFS

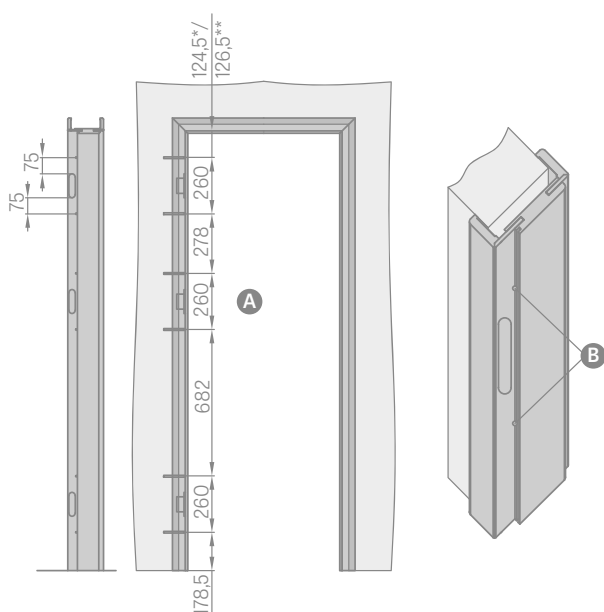

*Adj. cover list 6 cm / **Adj. cover list 8 cm

- A** Drill holes for metal screws min. 80 mm long x \varnothing 6 mm
- B** At assembly of frame, it is required to use mounting anchors together with mounting foam. The seal should cover the holes drilled underneath

HERSE SET DEFAULT ACCESSORIES

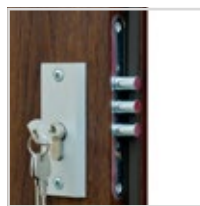

upper anti-burglary lock



door leaf 46 mm enforcement with massive iron profile

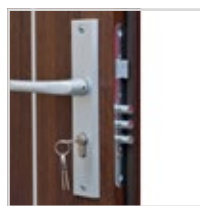

lower anti-burglary lock

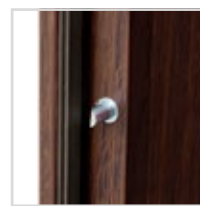

anti-burglary contact bolts



main frame plate with regulation



two pintle hinge \varnothing 16 with 3D regulation



fixed frame



threshold of hard wood (not painted)

MILLING IN HERSE DOOR LEAFS

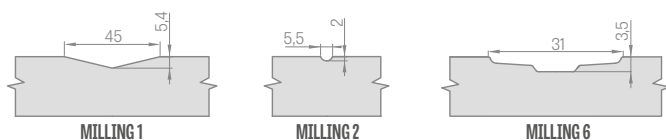

TYPE OF MILLING TO HERSE MAX			
HERSE MAX 1	HERSE MAX 2	HERSE MAX 3	HERSE MAX 6
MILLING 6	MILLING 6	MILLING 6	MILLING 6
HERSE MAX 7	HERSE MAX 13	HERSE MAX 14	HERSE MAX 22
MILLING 6	MILLING 1	MILLING 2	MILLING 2

HARDWARE TO NON-REBATED

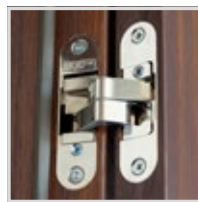

hidden hinge



magnetic lock



magnetic lock plate with regulation



door leaf faced with frame



SLIDING SYSTEM

ON-WALL

ON-WALL SLIDING SYSTEM:

SINGLE SP1Nz (with hook)	
SINGLE SP1Nb (without hook)	
DOUBLE SP2N	

Price includes:

Aluminium rail with masking box in the colour of door leaf:

- 210 cm long to doors "100"
- 200 cm long to doors "90"
- 180 cm long to doors "80"
- 150 cm long to doors "70", "60"

Available configurations of on-wall sliding systems:

- aluminium rail with masking trim and borderer (only SP1Nz and SP1Nb)
- aluminium rail with masking trim and tunnel frame (only SP2N)
- aluminium rail with borderer and tunnel frame (only SP1Nz and SP1Nb)
- aluminium rail with masking trim and with borderer and tunnel frame (only SP1Nz and SP1Nb)

It is not possible to have ventilation cut in non-rebated door leaves to in-wall sliding system.

ACCESSORIES CHARGED ADDITIONALLY

adjustable tunnel frame in the price of adjustable frame

hook lock with hardware
only to single system

oval holder or round holder in the following colours: chrome gloss, brushed chrome, brass gloss; a set of holders consists with two pieces

synch system

system that allows for opening and closing two non-rebate door leaves equally at the same time by using only one door leaf.
only to SP2N

door-closer

automatic system of closing the door leaf in its ending phase.
available only for SP1Nz i SP1Nb

ROUND AND OVAL METAL HOLDERS

chrome gloss, brushed chrome, brass gloss



HOOK LOCK FOR KEY

chrome gloss,
brushed chrome,
brass gloss

Key comes only in
silver colour

Hook lock set includes two
silver holders





ON-WALL SLIDING SYSTEM

WITH FRAME

SP1Nz or SP1Nb (left; obverse glazing)

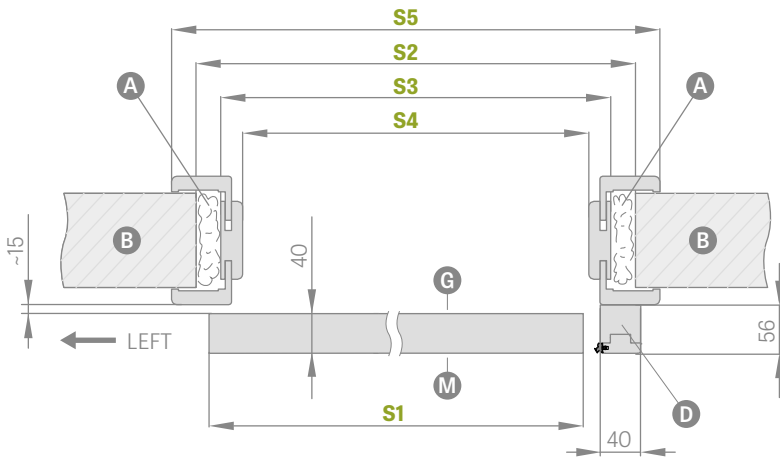

SP2N (obverse glazing)

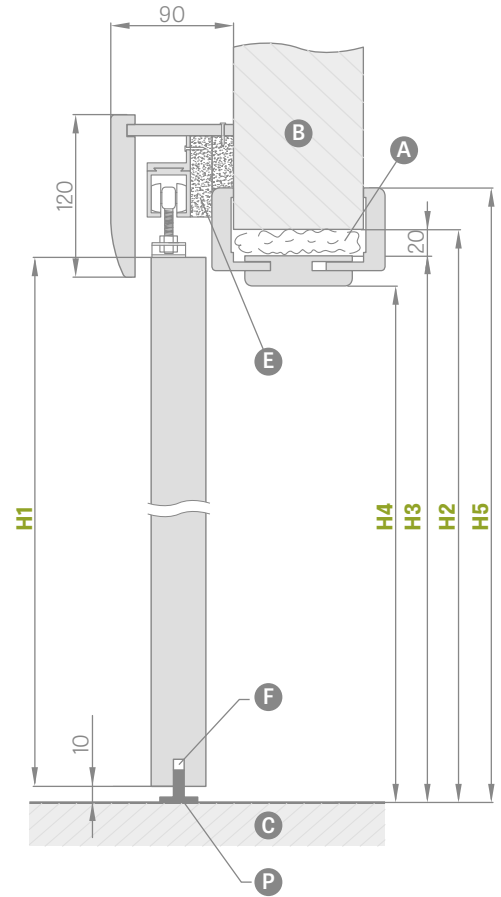
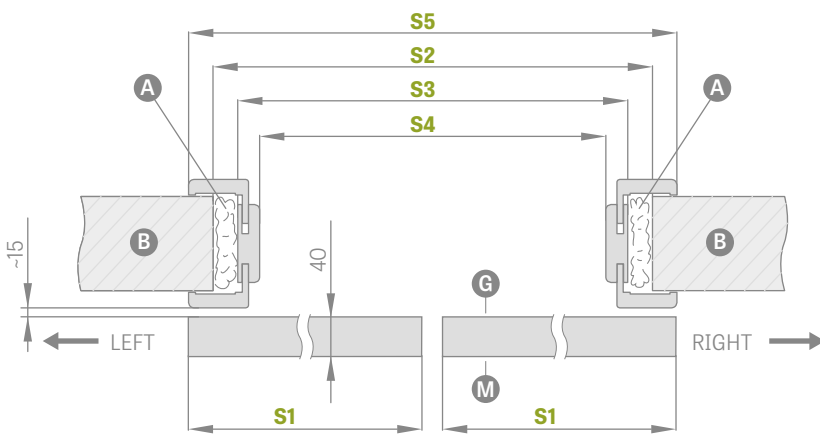

- A**— mounting foam
- B**— wall
- C**— floor
- D**— borderer
- E**— distance profiles
- F**— milling for the rail
- G**— glass smooth side
- M**— glass matt side
- P**— flooring rail

SLIDING SYSTEM WITH FRAME

SINGLE DOOR LEAF SP1N

DOUBLE DOOR LEAFS SP2N

		,60"	,70"	,80"	,90"	,100"	,60" x 2	,70" x 2	,80" x 2	,90" x 2	,100" x 2
S1	Width of door leaf	644	744	844	944	1044	1288	1488	1688	1888	2088
S2	Width of hole in wall	688	788	888	988	1088	1288	1488	1688	1888	2088
S3	Frame width	648	748	848	948	1048	1248	1448	1648	1848	2048
S4	Door frame clear width	604	704	804	904	1004	1204	1404	1604	1804	2004
S5	Frame covering width adj. cover list 6 cm/adj. cover list 8cm	746/ 786	846/ 886	946/ 986	1046/ 1086	1146/ 1186	1346/ 1386	1546/ 1586	1746/ 1786	1946/ 1986	2146/ 2186
H1	Height of door leaf	2030	2030	2030	2030	2030	2030	2030	2030	2030	2030
H2	Height of hole in wall	2060	2060	2060	2060	2060	2060	2060	2060	2060	2060
H3	Frame height	2040	2040	2040	2040	2040	2040	2040	2040	2040	2040
H4	Door frame clear height	2018	2018	2018	2018	2018	2018	2018	2018	2018	2018
H5	Door frame clear height adj. cover list 6 cm/adj. cover list 8cm	2089/ 2109	2089/ 2109	2089/ 2109	2089/ 2109	2089/ 2109	2089/ 2109	2089/ 2109	2089/ 2109	2089/ 2109	2089/ 2109



ON-WALL SLIDING SYSTEM

WITHOUT THE FRAME

SP1Nz or SP1Nb (left; reverse glazing)

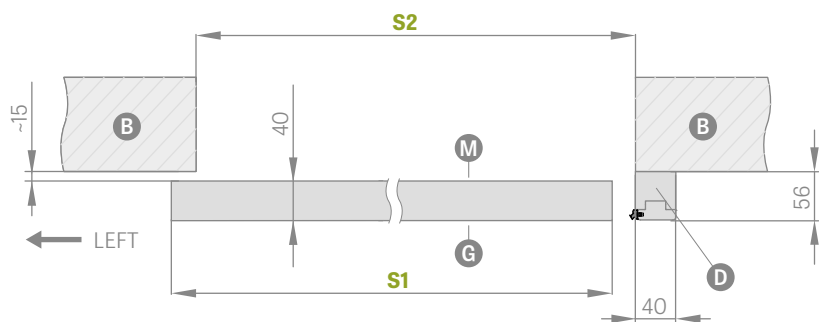

SP2N (reverse glazing)

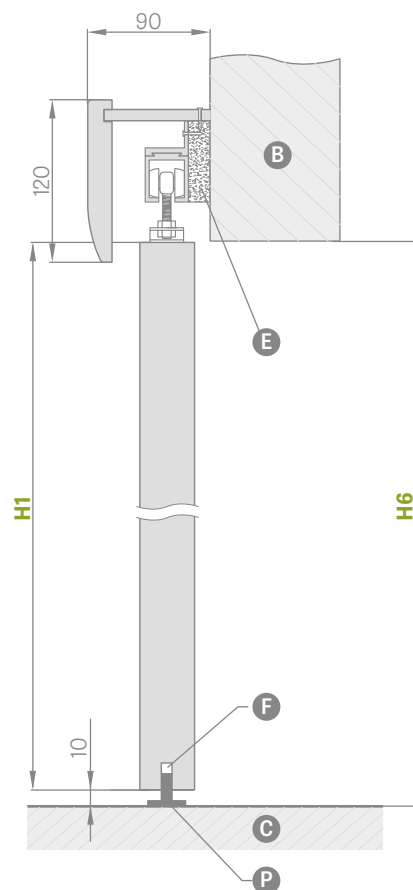
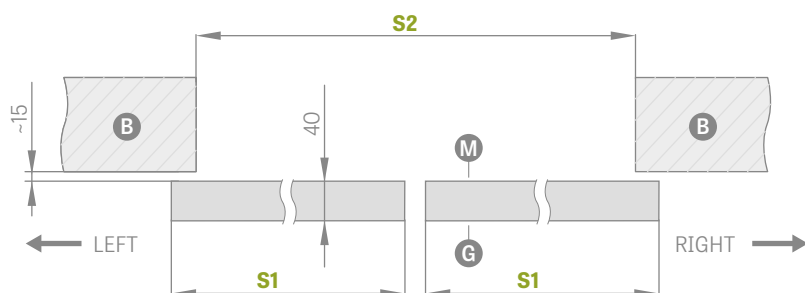

- B** - wall
- D** - borderer
- F** - milling for the rail
- P** - flooring rail
- C** - floor
- E** - distance profiles
- G** - glass smooth side
- M** - glass matt side

SLIDING SYSTEM WITHOUT FRAME





		SINGLE DOOR LEAF					SINGLE DOOR LEAF				
		„60“	„70“	„80“	„90“	„100“	„60“ x 2	„70“ x 2	„80“ x 2	„90“ x 2	„100“ x 2
S1	Width of door leaf	644	744	844	944	1044	1288	1488	1688	1888	2088
S2	Width of hole in wall	602	702	802	902	1002	1202	1402	1602	1802	2002
H1	Height of door leaf	2030	2030	2030	2030	2030	2030	2030	2030	2030	2030
H6	Height of hole in wall	2020	2020	2020	2020	2020	2020	2020	2020	2020	2020

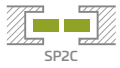

SLIDING SYSTEMS

IN-WALL

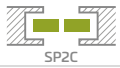
ERKADO offers the following types of in-wall sliding systems:

TUNNEL CONSTRUCTION		
SP1C.100		SINGLE IN-WALL SLIDING SYSTEM TO CASSETTE 100 WIDE available only to STILE door leaves (excluding DALIA) and model UNO PLAIN, UNO PREMIUM and UNO LUX
SP2C.100		DOUBLE IN-WALL SLIDING SYSTEM TO CASSETTE 100 WIDE available only to STILE door leaves (excluding DALIA) and model UNO PLAIN, UNO PREMIUM and UNO LUX
SP1C.125		SINGLE IN-WALL SLIDING SYSTEM TO CASSETTE 125 WIDE
SP2C.125		DOUBLE IN-WALL SLIDING SYSTEM TO CASSETTE 125 WIDE
SP1C100.ZN SP1C125.ZN		SINGLE IN-WALL SLIDING SYSTEM TO WALL MOUNTING TO CASSETTE 100 AND 125 WIDE
SP2C100.ZN SP2C125.ZN		DOUBLE IN-WALL SLIDING SYSTEM TO WALL MOUNTING TO CASSETTE 100 and 125 WIDE

$$\text{PRICE OF SLIDING SYSTEM} = \text{PRICE OF DOOR LEAF} + \text{PRICE OF ALUMINIUM CASSETTE} + \text{PRICE OF TUNNEL FRAME}$$

Standard set of in-wall single/double sliding system includes the following elements:

- aluminium cassette [LEON] SP1
- aluminium cassette [LEON] SP2
- non-rebated door leaf/two non rebated door leaves
- tunnel frame construction

ROUND METAL HOLDERS

chrome gloss, brushed chrome, brass gloss



HOOK LOCK FOR KEY

chrome gloss,
brushed chrome,
brass gloss

Hook lock set includes
two silver holders

Key comes only in silver colour



ACCESSORIES CHARGED ADDITIONALLY

hook lock with hardware

available only to: SP1C.100, SP1C.125, SP1C100.ZN i SP1C125.ZN

oval holder or **round holder** in the following colours: chrome gloss, brushed chrome, brass gloss

available only to SP1C.100, SP2C.100, SP1C.125, SP2C.125, SP1C100.ZN , SP1C125.ZN, SP2C100.ZN , SP2C125.ZN

set of holders consists of two pieces

thimble holder in colors: chrome gloss, brushed chrome, brass gloss

synch system

system that allows for opening and closing two non-rebate door leaves equally at the same time by using only one door leaf.
available only to: SP2C.100, SP2C100.ZN i SP2C125.ZN

door-closer

automatic system of closing the door leaf in its ending phase. Available only for SP1C.100, SP1C125, SP1C100.ZN and SP1C125.ZN



Adjustment range of basic wall thickness min.max. (mm)	
65-85;	85-105;
105-125	
125-145;	145-165;
165-185;	
185-205;	205-225;
225-245	
245-265;	265-285
285-305;	305-325
325-345;	345-365
365-385;	385-405

- Basic wall mounting is sold only in set including tunnel mounting
- It is possible to construct gypsym board to range 485-505 mm
– charge for every 2 cm of range is based on the price of frame 385-405 mm

single and double in-wall sliding systems

		,60"	,70"	,80"	,90"	,100"	2 x ,60"	2 x ,70"	2 x ,80"	2 x ,90"	2 x ,100"
S1	Width of door leaf	644	744	844	944	1044	1288	1488	1688	1888	2088
S2	Door frame clear width	602	702	802	902	1002	1202	1402	1602	1802	2002
S3	Width of cassette/hole in wall	1318	1518	1718	1918	2118	2538	2938	3338	3738	4138
S4	Frame covering width adj. cover list 6cm/adj. cover list 8cm	744 / 784	844 / 884	944 / 984	1044 / 1084	1144 / 1184	1344 / 1384	1544 / 1584	1744 / 1784	1944 / 1984	2144 / 2184
S5	Cassette hole width	655	755	855	955	1055	1255	1455	1655	1855	2055
H1	Height of door leaf	2030	2030	2030	2030	2030	2030	2030	2030	2030	2030
H2	Door frame clear height adj. cover list 6cm/adj. cover list 8cm	2092 / 2112	2092 / 2112	2092 / 2112	2092 / 2112	2092 / 2112	2092 / 2112	2092 / 2112	2092 / 2112	2092 / 2112	2092 / 2112
H3	Height of cassette/hole in wall	2115	2115	2115	2115	2115	2115	2115	2115	2115	2115
H4	Door frame clear height	2021	2021	2021	2021	2021	2021	2021	2021	2021	2021



In-wall sliding system

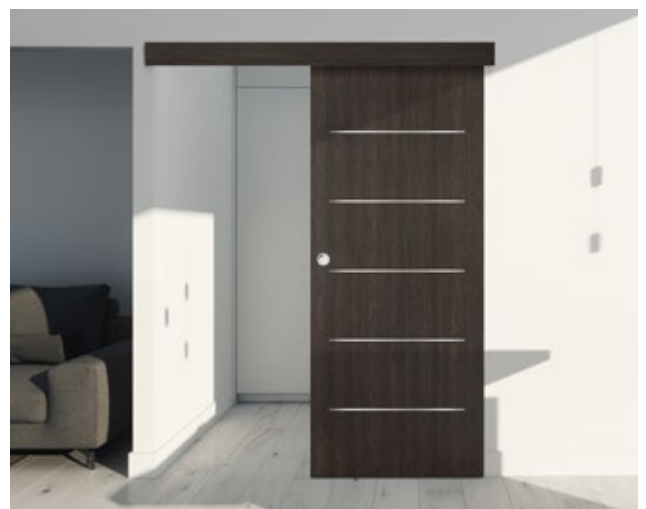

On-wall sliding system





SINGLE SLIDING SYSTEMS

IN-WALL



SP1C.100 (left; obverse glazing)

fixed scope 100 mm

Cassette thickness before gypsum board construction - 75 mm

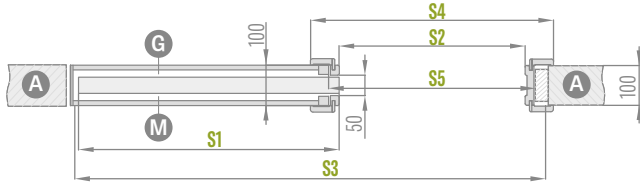

Only to UNO PLAIN, UNO PREMIUM, UNO LUX models and STILE door leaf, excluding DALIA model. The system does not include and require anti-dust brushes.

changeable scope 101 - 174 mm

Cassette thickness before gypsum board construction - 75 mm

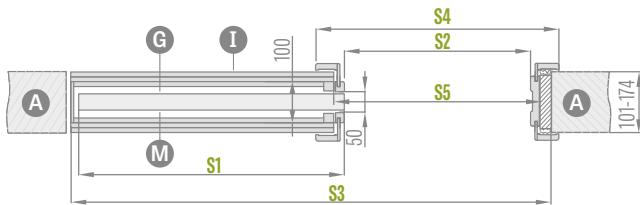

Only to UNO PLAIN, UNO PREMIUM, UNO LUX models and STILE door leaf, excluding DALIA model. The system does not include and require anti-dust brushes.

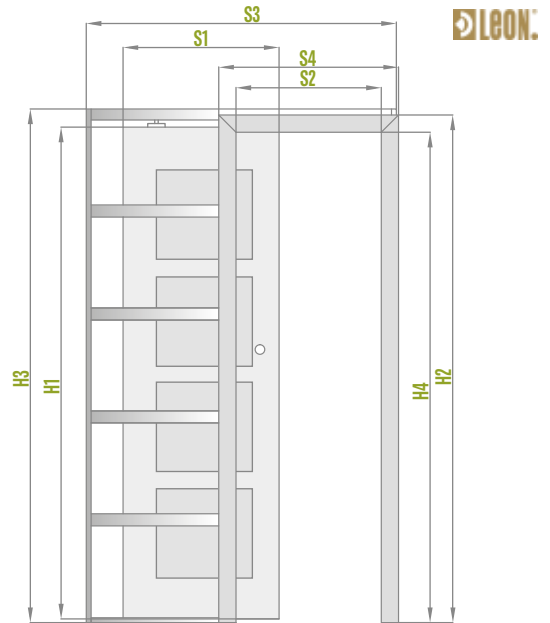

- A** - wall
- G** - glass smooth side
- M** - glass matt side
- I** - gypsum board
- S** - anti-dust brushes

SP1C.125 (left; obverse glazing)

fixed scope 125 mm

Cassette thickness before gypsum board construction - 100 mm

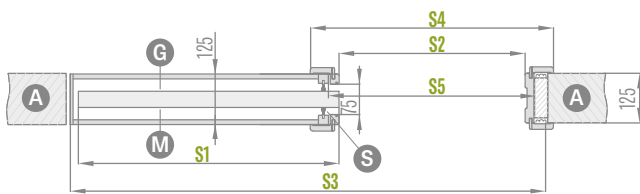

changeable scope 126 - 199 mm

Cassette thickness before gypsum board construction - 100 mm

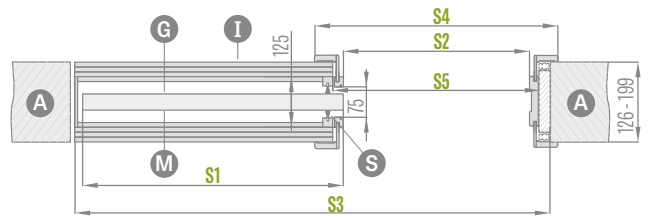

The feather of door square is to be cut to a given range of adjustment individually by the Customer

SP1C.125ZN (left; obverse glazing)

the scope of basic wall mounting from 65-85; 85-105; ... 385-405

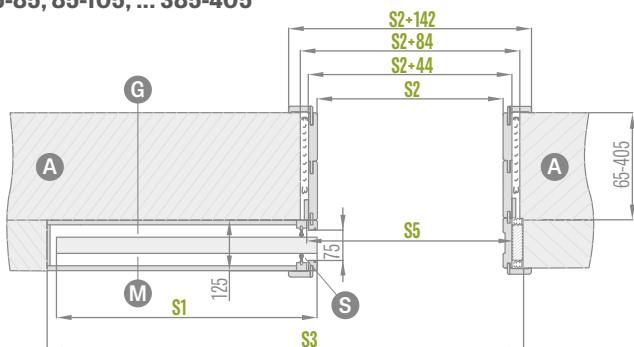

The range does not include mounting of the cassette 125 wide

SP1C.100ZN (left; obverse glazing)

the scope of basic wall mounting from 65-85; 85-105; ... 385-405

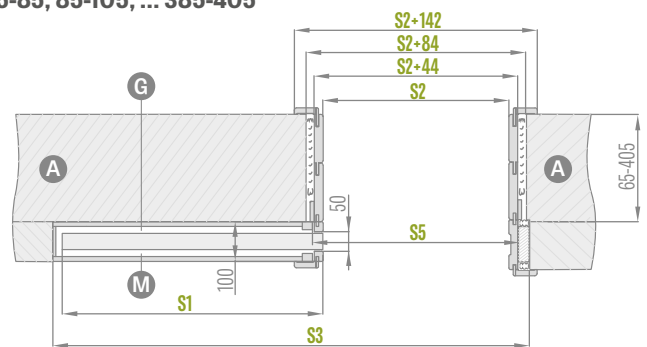

The range does not include mounting of the cassette 100 wide. The system can be applied only to UNO PLAIN, UNO PREMIUM, UNO LUX models and STILE model excluding DALIA model.





DOUBLE SLIDING SYSTEMS

IN-WALL

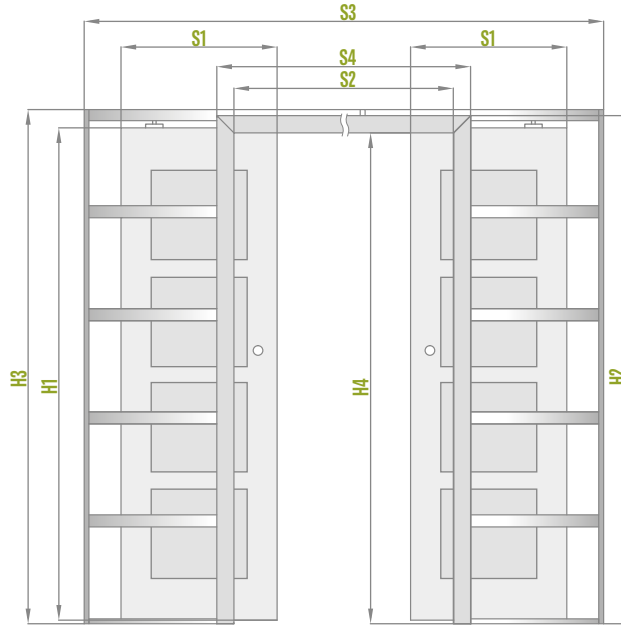

SP2C.100 (obverse glazing)

fixed scope 100 mm

Cassette thickness before gypsum board construction - 75 mm



Only to UNO PLAIN, UNO PREMIUM, UNO LUX models and STILE door leaf, excluding DALIA model.
The system does not include and require anti-dust brushes.

changeable scope 101 - 174 mm

Cassette thickness before gypsum board construction - 75 mm



Only to UNO PLAIN, UNO PREMIUM, UNO LUX models and STILE door leaf, excluding DALIA model.
The system does not include and require anti-dust brushes.

- A** - wall
- G** - glass smooth side
- M** - glass matt side

- I** - gypsum board
- S** - anti-dust brushes



DOUBLE SLIDING SYSTEMS

IN-WALL

SP2C.125 (obverse glazing)

fixed scope 125 mm

Cassette thickness before gypsum board construction - 100 mm)

- A** - wall
- G** - glass smooth side
- M** - glass matt side

- I** - gypsum board
- S** - anti-dust brushes

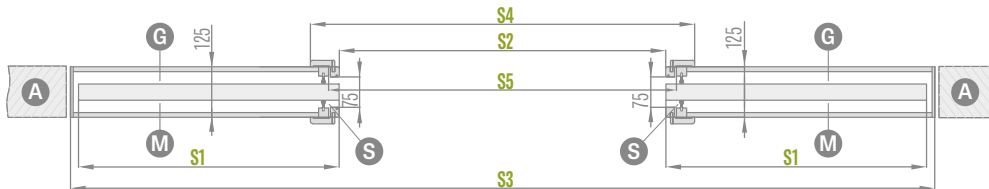

changeable scope 126 - 199 mm

Cassette thickness before gypsum board construction - 100 mm)

The feather of door square is to be cut to a given range of adjustment individually by the Customer



SP2C.125ZN (obverse glazing)

the scope of basic wall mounting from 65-85; 85-105; ... 385-405

The range does not include mounting of the cassette 125 wide

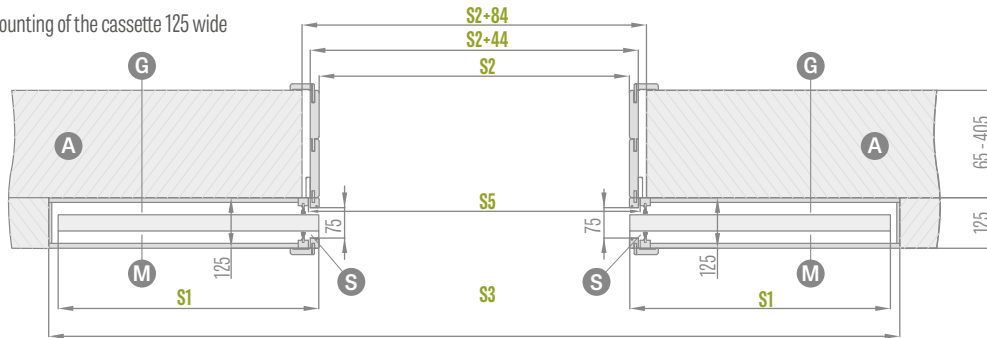

SP2C.100ZN (obverse glazing)

the scope of basic wall mounting from 65-85; 85-105; ... 385-405

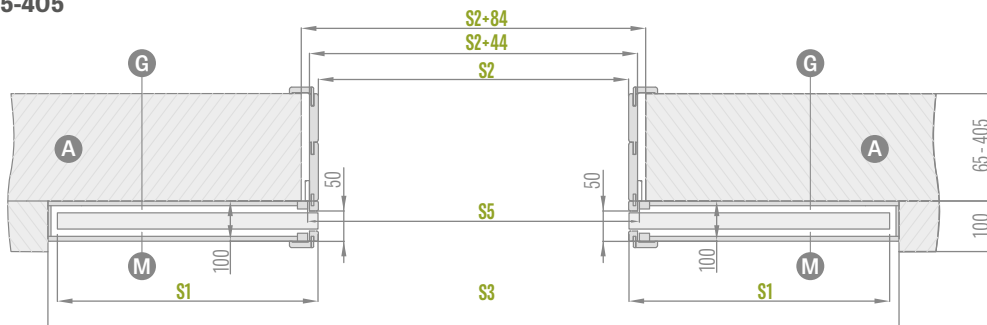

The range does not include mounting of the cassette 100 wide. The system can be applied only to UNO PLAIN, UNO PREMIUM, UNO LUX model and STILE model excluding DALIA model. The system does not include and require anti-dust brushes.



DOUBLE DOORS

REBATED, NON-REBATED

PRACTICAL INFORMATION:

DOUBLE DOORS



- In double doors the homalight filling is available and is extra charged
- Double doors are available for all models in STANDARD, SOFT and STILE technology in colours and configurations respectively
- Passive door leaf is equipped with sash stops with door latch
- Passive door leaf below width 60 comes only as the full plain leaf – so called 'side leaf' (see the picture below)
- 'side leaf' is available only in honey comb core filling and vertical ringing
- Working and passive door leaves are equipped with door sashes
- Double doors in non-rebated technologies are available only with magnetic lock
- Non-rebated double doors come only with adjustable frame

AVAILABLE DOOR WIDTHS:

- board and stile double doors from 120 to 190 wide with the configuration of plain side leaf

60 + 30*	70 + 30*	80 + 30*	90 + 30*	100 + 30*
60 + 40*	70 + 40*	80 + 40*	90 + 40*	100 + 40*
60 + 50*	70 + 50*	80 + 50*	90 + 50*	100 + 50*

- * Side door leaf ('side leaf') is available only in STANDARD technology as full plain
- ** up to '180' for non-rebated door leaves

The price of double doors:

- Board and STILE doors: working door leaf **60 70 80 90 100** + passive door leaf **60 70 80 90***

$$\text{Price of double door leaf with the sash} = \text{door leaf price} \times 2 + \text{door sashes}$$

- Board and STILE doors: working door leaf **60 70 80 90 100** + passive plain side leafs **30 40 50**

$$\text{Price of double door leaf with 'side leaf' and the sash} = \text{door leaf price} + \text{side leaf with door sashes}$$

- the price of double door fixed or adjustable frame + 30%

* does not concern non-rebated door leaves bezprzylgowych



DOUBLE DOORS

NON-REBATED

NON-REBATED DOUBLE DOORS
WITH ADJUSTABLE FRAME

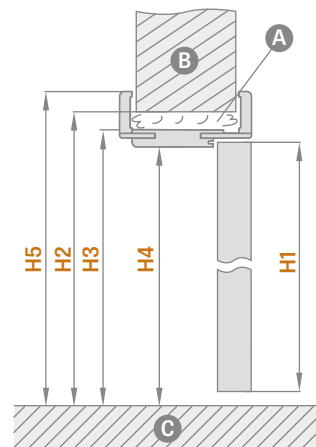
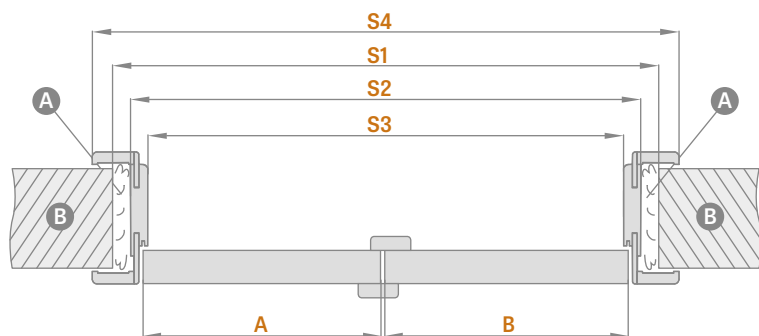

A—mounting foam B—wall C—floor

Adjustable frame		NON-REBATED DOUBLE DOORS									
		,90"	,100"	,110"	,120"	,130"	,140"	,150"	,160"	,170"	,180"
A+B	Width of door leaf	988	1088	1188	1288	1388	1488	1588	1688	1788	1888
S1	Width of hole in wall	1061	1161	1261	1361	1461	1561	1661	1761	1861	1961
S2	Frame width	1021	1121	1221	1321	1421	1521	1621	1721	1821	1921
S3	Door frame clear width	977	1077	1177	1272	1377	1477	1577	1677	1777	1877
S4	Frame covering width adj. cover list 6 cm/adj. cover list 8 cm	1119 / 1159	1219 / 1259	1319 / 1359	1419 / 1459	1519 / 1559	1619 / 1659	1719 / 1759	1819 / 1859	1919 / 1959	2019 / 2059
H1	Height of door leaf	2030	2030	2030	2030	2030	2030	2030	2030	2030	2030
H2	Height of hole in wall	2073	2073	2073	2073	2073	2073	2073	2073	2073	2073
H3	Frame height	2053	2053	2053	2053	2053	2053	2053	2053	2053	2053
H4	Door frame clear height	2031	2031	2031	2031	2031	2031	2031	2031	2031	2031
H5	Door frame clear height adj. cover list 6 cm/Adj. cover list 8 cm	2102 / 2122	2102 / 2122	2102 / 2122	2102 / 2122	2102 / 2122	2102 / 2122	2102 / 2122	2102 / 2122	2102 / 2122	2102 / 2122

DOUBLE DOORS
- SYMETRIC



DOUBLE DOORS
- NON-SYMETRIC



DOUBLE DOORS
- SIDE LEAF

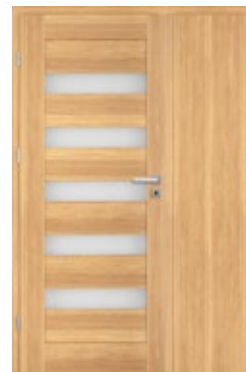



DOUBLE DOORS

REBATED

REBATED DOUBLE DOORS WITH ADJUSTABLE FRAME

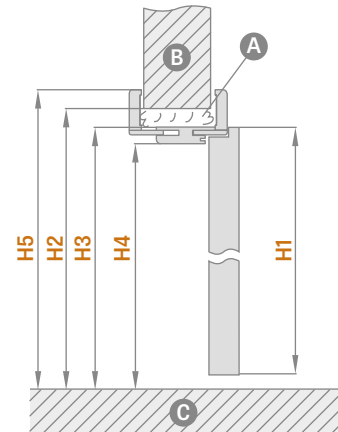
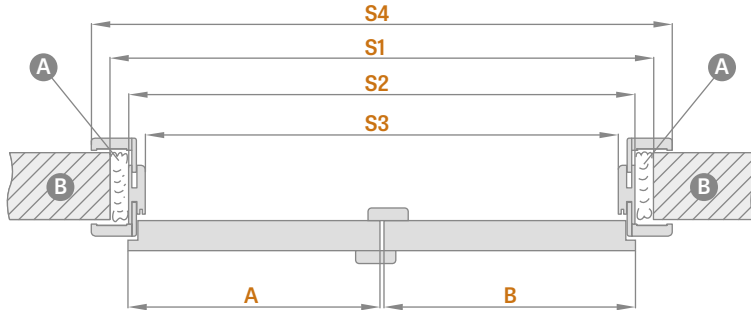

A – mounting foam B – wall C – floor

Adjustable frame	DOUBLE DOORS											
	,90"	,100"	,110"	,120"	,130"	,140"	,150"	,160"	,170"	,180"	,190"	
A+B Width of door leaf	960	1060	1160	1260	1360	1460	1560	1660	1760	1860	1960	
S1 Width of hole in wall	1006	1106	1206	1306	1406	1506	1606	1706	1806	1906	2006	
S2 Frame width	966	1066	1166	1266	1366	1466	1566	1666	1766	1866	1966	
S3 Door frame clear width	922	1022	1122	1222	1322	1422	1522	1622	1722	1822	1922	
S4 Frame covering width adj. cover list 6 cm/adj. cover list 8 cm	1064 / 1104	1164 / 1204	1264 / 1304	1364 / 1404	1464 / 1504	1564 / 1604	1664 / 1704	1764 / 1804	1864 / 1904	1964 / 2004	2064 / 2104	
H1 Height of door leaf	2030	2030	2030	2030	2030	2030	2030	2030	2030	2030	2030	
H2 Height of hole in wall	2060	2060	2060	2060	2060	2060	2060	2060	2060	2060	2060	
H3 Frame height	2040	2040	2040	2040	2040	2040	2040	2040	2040	2040	2040	
H4 Door frame clear height	2018	2018	2018	2018	2018	2018	2018	2018	2018	2018	2018	
H5 Door frame clear height adj. cover list 6 cm/adj. cover list 8 cm	2089 / 2109	2089 / 2109	2089 / 2109	2089 / 2109	2089 / 2109	2089 / 2109	2089 / 2109	2089 / 2109	2089 / 2109	2089 / 2109	2089 / 2109	

REBATED DOUBLE DOORS WITH FIXED FRAME

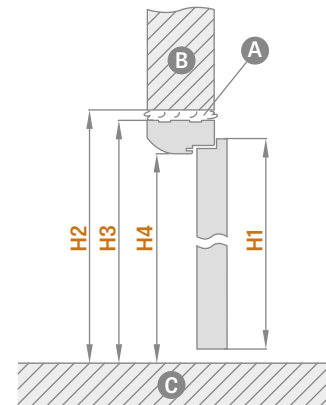
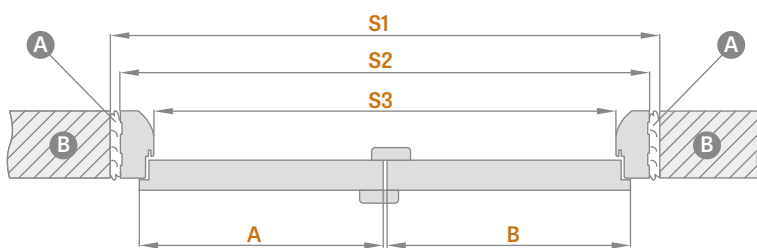

A – mounting foam B – wall C – floor

Fixed frame	DOUBLE DOORS											
	,90"	,100"	,110"	,120"	,130"	,140"	,150"	,160"	,170"	,180"	,190"	
A+B Width of door leaf	960	1060	1160	1260	1360	1460	1560	1660	1760	1860	1960	
S1 Width of hole in wall	1040	1140	1240	1340	1440	1540	1640	1740	1840	1940	2040	
S2 Frame width	1010	1110	1210	1310	1410	1510	1610	1710	1810	1910	2010	
S3 Door frame clear width	922	1022	1122	1222	1322	1422	1522	1622	1722	1822	1922	
H1 Height of door leaf	2030	2030	2030	2030	2030	2030	2030	2030	2030	2030	2030	
H2 Height of hole in wall	2077	2077	2077	2077	2077	2077	2077	2077	2077	2077	2077	
H3 Frame height	2062	2062	2062	2062	2062	2062	2062	2062	2062	2062	2062	
H4 Door frame clear height	2018	2018	2018	2018	2018	2018	2018	2018	2018	2018	2018	

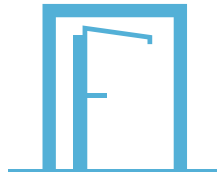

HIDDEN DOORS SYSTEM

OPENING INSIDE AND OUTSIDE



REBATED AND NON-REBATED DOOR LEAF

ALUMINIUM HIDDEN FRAME

CONSTRUCTION

- rebated or non-rebated door leaf
- wooden rail covered with two HDF boards
- stabilising filling honeycomb core

FINISHING

- HDF board covered with diagonal foil, PREMIUM or to be painted/taped
- the edge of door leaf made in rebate or non-rebate technology

HARDWARE

- two hidden hinges set in the door frame
- magnetic lock in rebated door leaf and lock for key, cylinder, economy or with blockage in non-rebated door leaf

ACCESSORIES CHARGED ADDITIONALLY

homalight board

additional bottom construction bar (offers possibility to individual trim of door leaf up to 8 cm)

metal ventilation grill round and square (4 pieces)
finishing: brushed nickel or patina, white and black

plastic ventilation sleeves (4 pieces)

ventilation cut or ventilation grill

door leaf 100 wide

automatic door seal



NUT PREMIUM



GREY MAPLE PREMIUM



OAK PREMIUM



WHITE BARK PREMIUM



GRAPHITE ASH PREMIUM



CONCRETE PREMIUM



DIAGONAL LARCH



WHITE PREMIUM¹⁾



TO BE PAINTED/TAPED

AVAILABLE DOOR WIDTHS

60 70 80 90 100

¹⁾ white foil imitating painting surface



HIDDEN DOORS SYSTEM

REBATED DOOR LEAF OPENING INSIDE

REBATED DOOR LEAF

ALUMINIUM HIDDEN FRAME

STANDARD DIMENSIONS FOR REBATED DOOR LEAFS OPENING INSIDE

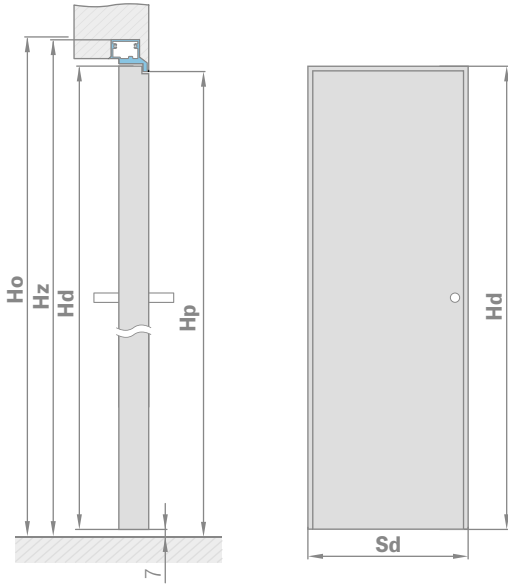

Door width	Construction hole width	Frame exterior width	Opening width
Sd [mm]	So [mm]	Sz [mm]	Sp [mm]
644	724	714	629
744	824	814	729
844	924	914	829
944	1024	1014	929
1044	1124	1114	1029

Door height	Construction hole height	Frame exterior height	Opening height
Hd [mm]	Ho [mm]	Hz [mm]	Hp [mm]
2030	2079	2072	2030

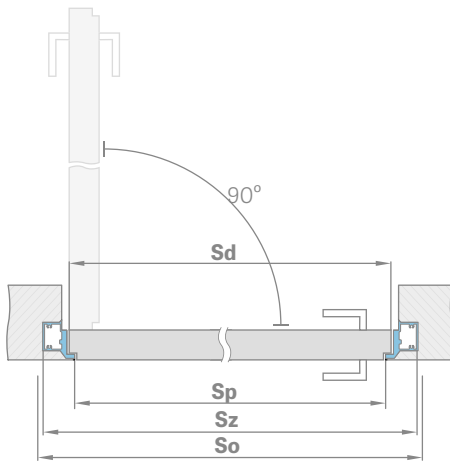

GYPSUM BOARD MOUNTING

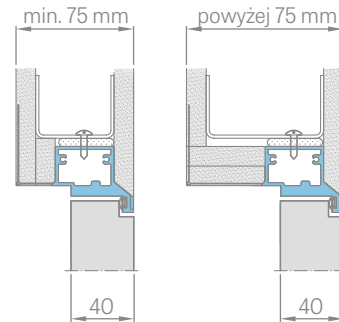

INTERSECTION OF ALUMINIUM FRAME

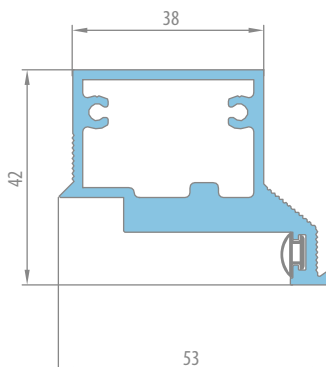

WALL MOUNTING

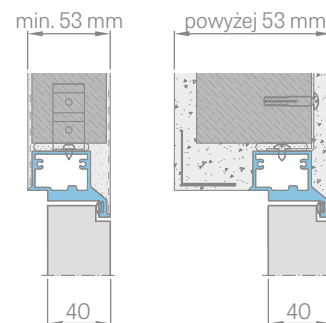



HIDDEN DOORS SYSTEM

NON-REBATED DOOR LEAF OPENING OUTSIDE

NON-REBATED DOOR LEAF

ALUMINIUM HIDDEN FRAME

STANDARD DIMENSIONS FOR NON-REBATED DOOR LEAFS OPENING OUTSIDE

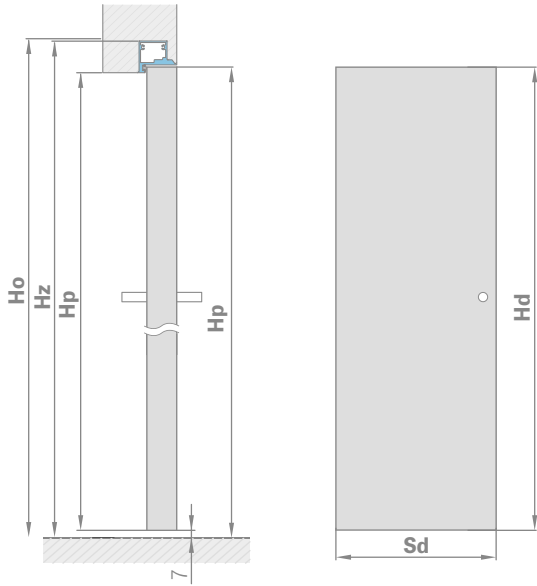

Door width	Construction hole width	Frame exterior width	Opening width
Sd [mm]	So [mm]	Sz [mm]	Sp [mm]
644	724	714	629
744	824	814	729
844	924	914	829
944	1024	1014	929
1044	1124	1114	1029

Door height	Construction hole height	Frame exterior height	Opening height
Hd [mm]	Ho [mm]	Hz [mm]	Hp [mm]
2020	2069	2062	2020

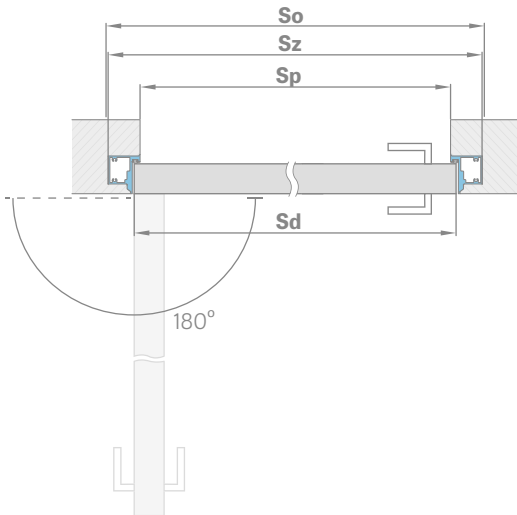

GYPSUM BOARD MOUNTING

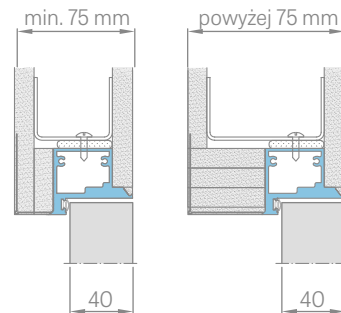

INTERSECTION OF ALUMINIUM FRAME

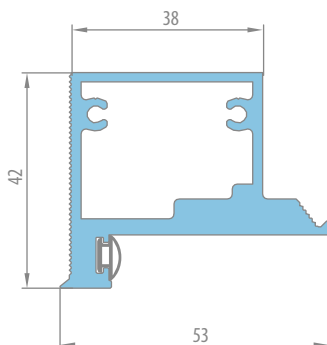

WALL MOUNTING

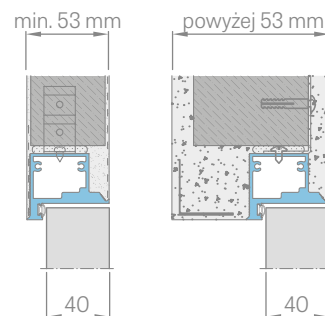



TRANSOMS

GENERAL INFORMATION

Transoms are factory-made and they are fixed with protection glass VSG 331 milk or transparent.
(This should be specified when making an order)

TYPES OF TRANSOMS

TO FIXED FRAME
TO ADJUSTABLE FRAME
TO SINGLE DOOR LEAFS
TO DOUBLE DOORS

AVAILABLE TRANSOMS:

SINGLE DOOR LEAFS with side, top and corner transoms

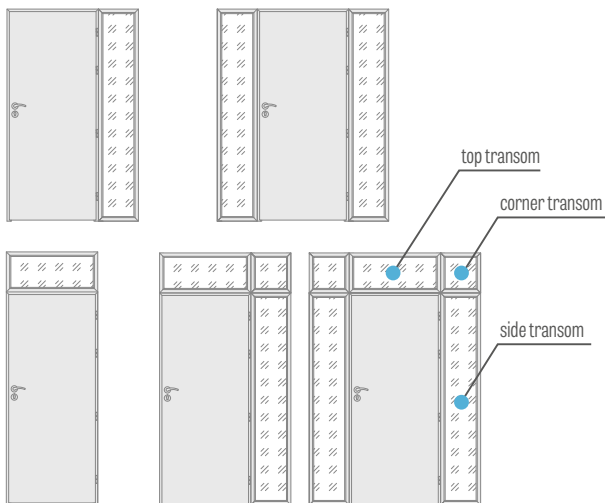

DOUBLE DOOR LEAFS with side, top and corner transoms

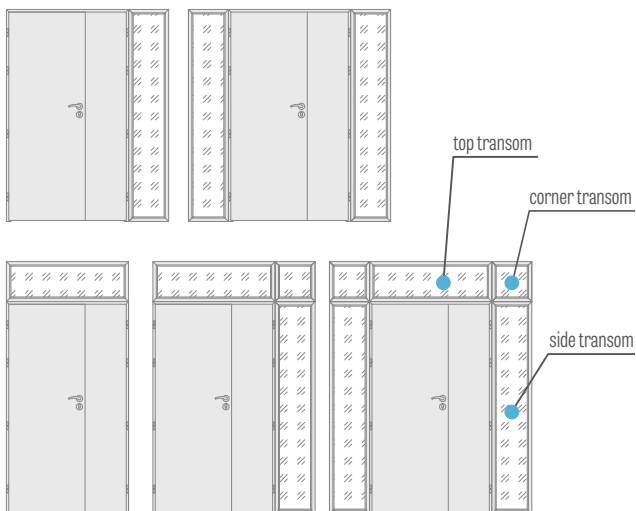

Side transoms of adjustable frame
Adj. cover list 6cm/Adj. cover list 8cm

„30“ „40“ „50“ „60“

446/486, 546/586, 646/686, 746/786

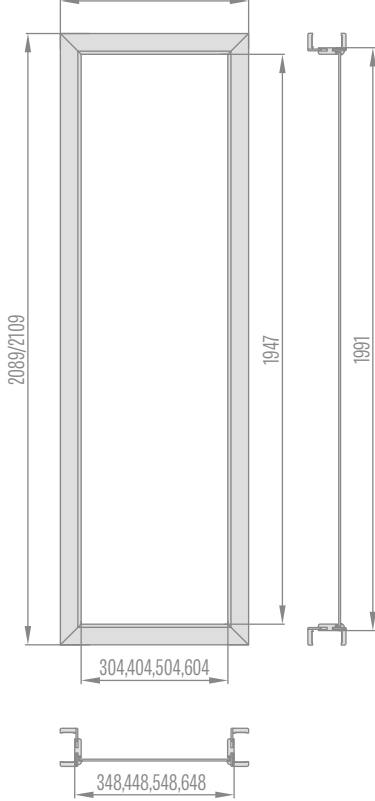

Corner transoms of adjustable frame
Adj. cover list 6cm/Adj. cover list 8cm

„30“ „40“ „50“ „60“

446/486, 546/586, 646/686, 746/786

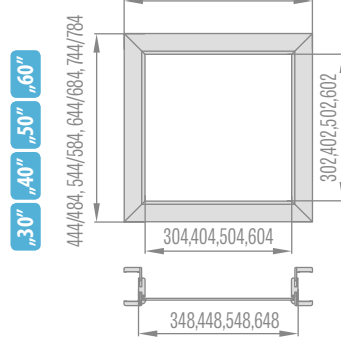

Top transoms of adjustable frame to single door leaves
Adj. cover list 6cm/Adj. cover list 8cm

„60“ „70“ „80“ „90“ „100“

746/786, 846/886, 946/986, 1046/1086, 1146/1186

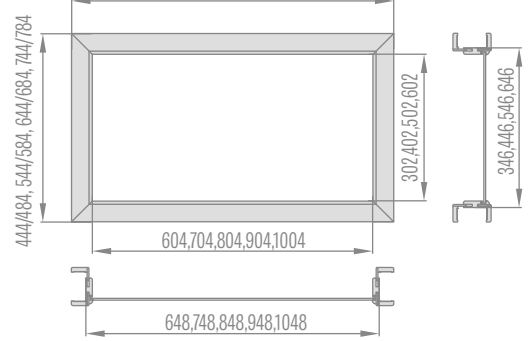

Top transoms of adjustable frame to double doors Adj. cover list 6cm/Adj. cover list 8cm

„90“ „100“ „110“ „120“ „130“ „140“ „150“ „160“ „170“ „180“ „190“

1066/1106, 1166/1206, 1266/1306, 1366/1406, 1466/1506, 1566/1606, 1666/1706, 1766/1806, 1866/1906, 1966/2006, 2066/2106

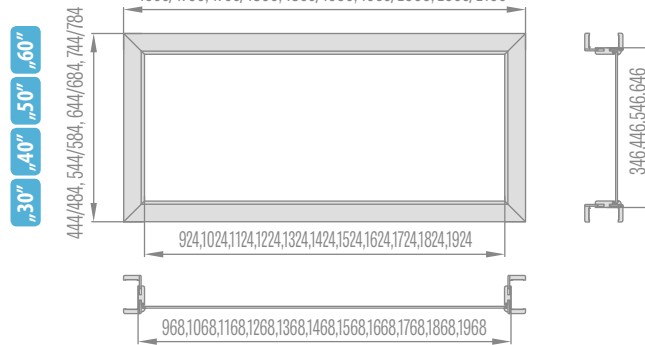

Side transoms of fixed frame

„30“ „40“ „50“ „60“

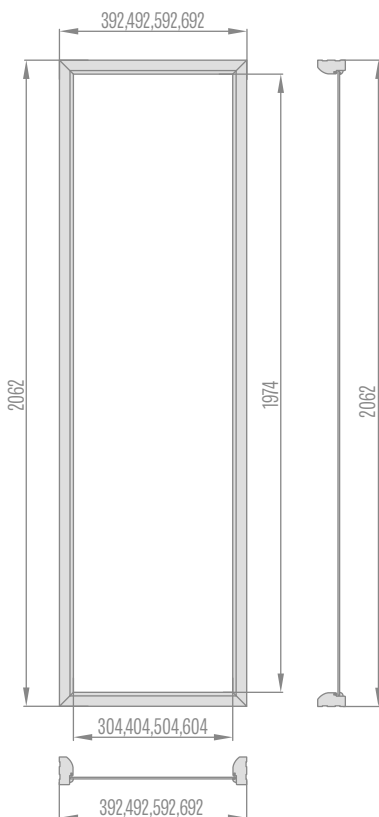

Corner transoms of fixed frames

„30“ „40“ „50“ „60“

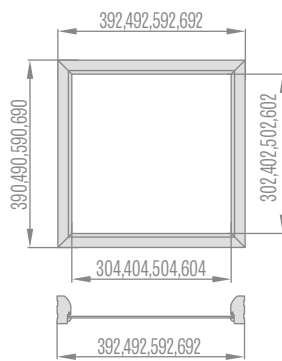

Top transoms of fixed frames to single door leaves

„60“ „70“ „80“ „90“ „100“

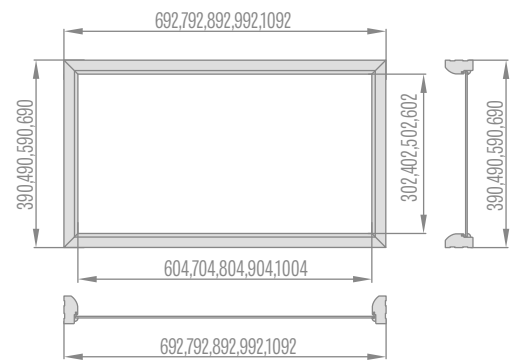

Top transoms of fixed frame to double doors

„90“ „100“ „110“ „120“ „130“ „140“ „150“ „160“ „170“ „180“ „190“



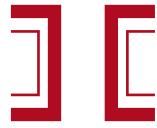

DOOR FRAMES

- Rebated adjustable and fixed frames can be applied to all kind of interior doors by ERKADO made in board STANDARD and SOFT technologies as well as in STILE technologies.
- Non-rebated adjustable frame can be applied to interior doors made in board technology as well as STILE technology. These frames include three hidden hinges.
- Frames are made of high quality MDF and are covered with durable foil imitating wood structures.
- Depending on technology, the frames are covered with the following types of finishing: finish foil, GREKO, CPL, PREMIUM and PVC.
- Frames to STILE doors have default third hinge.
- Each set of frame includes: separate elements of frame, hinges, screws. Particular elements have necessary drillings in the connection spots.
- Each set includes assembly instruction and guarantee card.
- Fixed frame to HERSE collection doors is square.

**ADJUSTABLE FRAME
REBATED LEAFS**



**ADJUSTABLE CASING
TO METAL FRAME**



**ADJUSTABLE FRAME
NON-REBATED LEAFS**



**SOFT FIXED FRAME
REBATED LEAFS**



**REGULAR SQUARE TO
ADJUSTABLE FRAME**

Adj. cover list 6 cm/Adj. cover list 8 cm

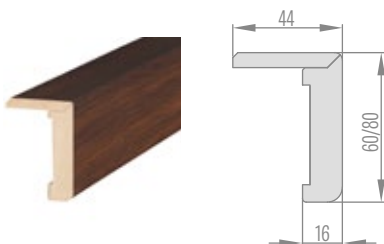

**SQUARE WITH EXTENDED
FEATHER TO ADJUSTABLE FRAME**

Adj. cover list 6 cm/Adj. cover list 8 cm

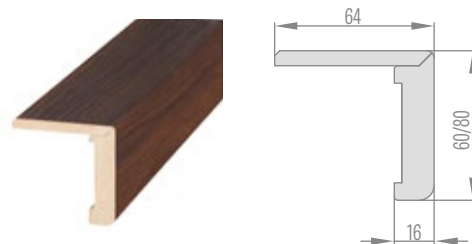

FIXED FRAME

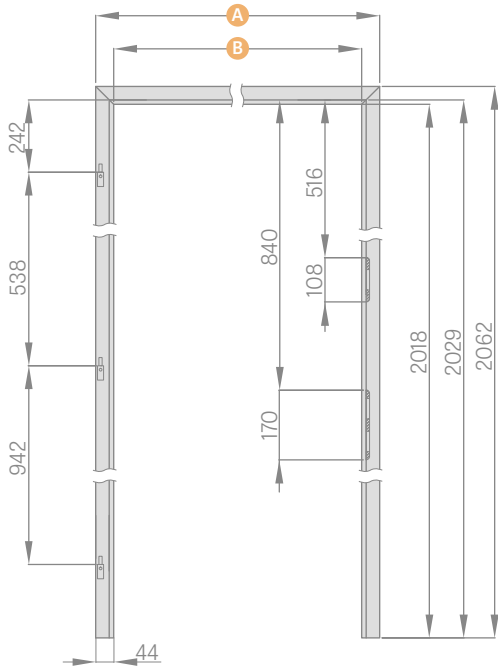

	.60"	.70"	.80"	.90"	.100"
A	692	792	892	992	1092
B	604	704	804	904	1004

ADJUSTABLE FRAME

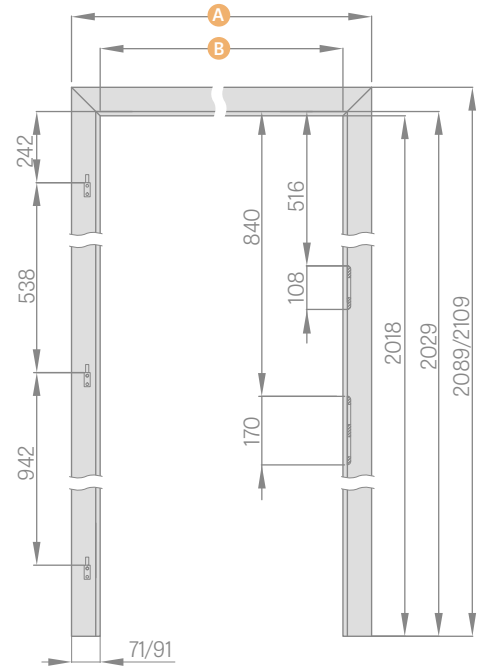

	.60"	.70"	.80"	.90"	.100"
A	746 / 786	846 / 886	946 / 986	1046 / 1086	1146 / 1186
B	604	704	804	904	1004

Adj. cover list 6cm/Adj. cover list 8cm

TUNNEL ADJUSTABLE FRAME

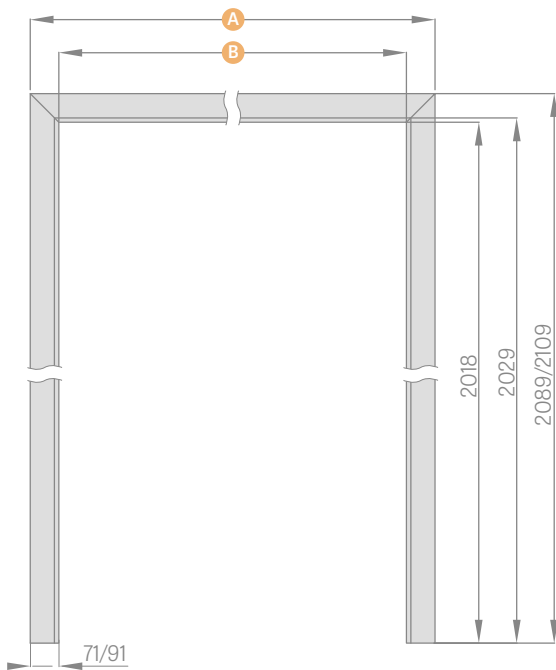

	.60"	.70"	.80"	.90"	.100"	.110"	.120"
A	746 / 786	846 / 886	946 / 986	1046 / 1086	1146 / 1186	1246 / 1286	1346 / 1386
B	604	704	804	904	1004	1104	1204
	.130"	.140"	.150"	.160"	.170"	.180"	.190"
A	1446 / 1486	1546 / 1586	1646 / 1686	1746 / 1786	1846 / 1886	1946 / 1986	2046 / 2086
B	1304	1404	1504	1604	1704	1804	1904

Adj. cover list 6cm/Adj. cover list 8cm

FRAME CASING

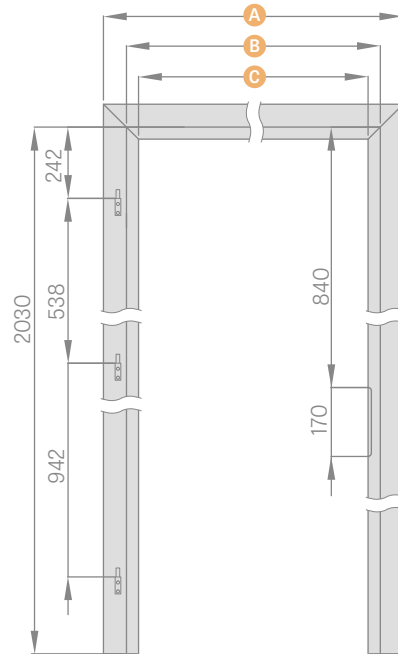

	.60"	.70"	.80"	.90"	.100"
A	737	837	937	1037	1137
B	624	724	824	924	1024
C	564	664	764	864	964

FIXED FRAME TO DOUBLE DOORS

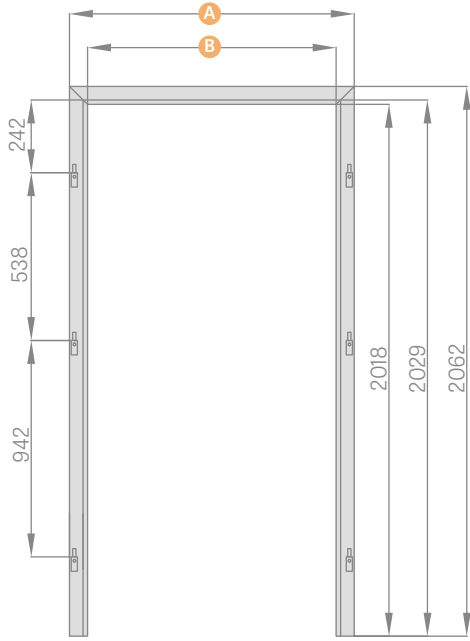

	,90"	,100"	,110"	,120"	,130"	,140"
A	1010	1110	1210	1310	1410	1510
B	922	1022	1122	1222	1322	1422

	,150"	,160"	,170"	,180"	,190"
A	1610	1710	1810	1910	2010
B	1522	1622	1722	1822	1922

ADJUSTABLE FRAME TO DOUBLE DOORS

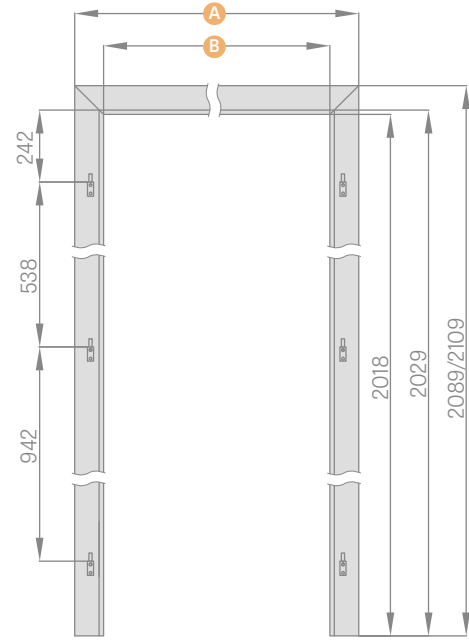

	,90"	,100"	,110"	,120"	,130"	,140"
A	1064/1104	1164/1204	1264/1304	1364/1404	1464/1504	1564/1604
B	922	1022	1122	1222	1322	1422

	,150"	,160"	,170"	,180"	,190"
A	1664/1704	1764/1804	1864/1904	1964/2004	2064/2104
B	1522	1622	1722	1822	1922

Adj. cover list 6 cm/Adj. cover list 8cm

FIXED FRAME TO GLASS DOORS

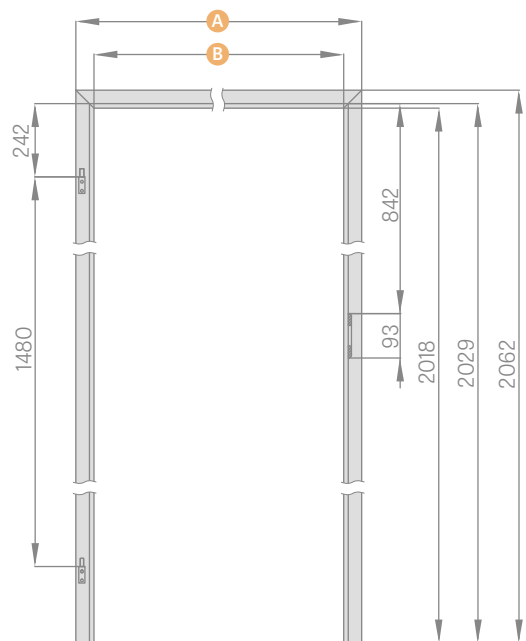

	,60"	,70"	,80"	,90"
A	692	792	892	992
B	604	704	804	904

ADJUSTABLE FRAME TO GLASS DOORS

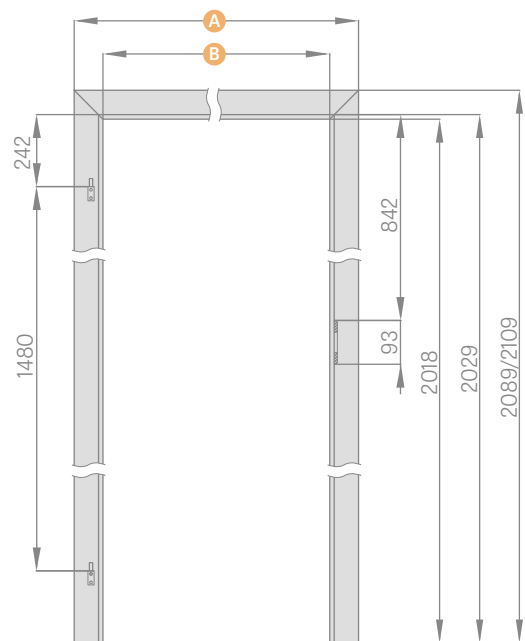

	,60"	,70"	,80"	,90"
A	746/786	846/886	946/986	1046/1086
B	604	704	804	904

Adj. cover list 6 cm/Adj. cover list 8cm



ADJUSTABLE TUNNEL FRAMES

REBATED, NON-REBATED

DOOR FRAMES TUNEL

Tunnel frame is an adjustable frame or fixed frame without any hardware. It is constructed with one horizontal and two vertical beams. It can be applied to decorate in-door spaces as the element of protection to wall edges.

Nevertheless more often it is used for the esthetical reasons as the decoration of the whole interior.

Rebated and non-rebated adjustable and fixed tunnel frames are also used in ERKADO sliding systems.

Non-rebated adjustable tunnel frames are not used in sliding systems.

Depending on the system we differentiate:

TUNNEL TO SP1N	Tunnel frame to single on-wall sliding system
TUNNEL TO SP2N	Tunnel frame to double on-wall sliding system
TUNNEL TO SP1C.100	Tunnel frame to single in-wall sliding system to cassette 100 wide
TUNNEL TO SP2C.100	Tunnel frame to double in-wall sliding system to cassette 100 wide
TUNNEL TO SP1C.125	Tunnel frame to single in-wall sliding system to cassette 125 wide
TUNNEL TO SP2C.125	Double in-wall sliding system to cassette 125 wide
TUNNEL TO SP1C.ZN	Single in-wall sliding system to wall mounting
TUNNEL TO SP2C.ZN	Double in-wall sliding system to wall mounting

REBATED ADJUSTABLE TUNNEL FRAMES

	,60"	,70"	,80"	,90"	,100"	,110"	,120"	,130"	,140"	,150"	,160"	,170"	,180"	,190"
Width of hole in wall	688	788	888	988	1088	1188	1288	1388	1488	1588	1688	1788	1888	1988
Tunnel exterior size	648	748	848	948	1048	1148	1248	1348	1448	1548	1648	1748	1848	1948
Tunnel clear width	604	704	804	904	1004	1104	1204	1304	1404	1504	1604	1704	1804	1904
Tunnel covering width Adj. cover list 6 cm/Adj. cover list 8 cm	746/ 786	846/ 886	946/ 986	1046/ 1086	1146/ 1186	1246/ 1286	1346/ 1386	1446/ 1486	1546/ 1586	1646/ 1686	1746/ 1786	1846/ 1886	1946/ 1986	2046/ 2086
Height of hole in wall	2060	2060	2060	2060	2060	2060	2060	2060	2060	2060	2060	2060	2060	2060
Tunnel exterior height	2040	2040	2040	2040	2040	2040	2040	2040	2040	2040	2040	2040	2040	2040
Tunnel clear height	2018	2018	2018	2018	2018	2018	2018	2018	2018	2018	2018	2018	2018	2018
Tunnel covering height Adj. cover list 6 cm/Adj. cover list 8 cm	2089/ 2109	2089/ 2109	2089/ 2109	2089/ 2109	2089/ 2109	2089/ 2109	2089/ 2109	2089/ 2109	2089/ 2109	2089/ 2109	2089/ 2109	2089/ 2109	2089/ 2109	2089/ 2109

NON-REBATED ADJUSTABLE TUNNEL FRAMES

	,60"	,70"	,80"	,90"	,100"	,110"	,120"	,130"	,140"	,150"	,160"	,170"	,180"
Width of hole in wall	713	813	913	1013	1113	1213	1313	1413	1513	1613	1713	1813	1913
Tunnel exterior size	673	773	873	973	1073	1173	1273	1373	1473	1573	1673	1773	1873
Tunnel clear width	629	729	829	929	1029	1129	1229	1329	1429	1529	1629	1729	1829
Tunnel covering width Adj. cover list 6 cm/Adj. cover list 8 cm	771/ 811	871/ 911	971/ 1011	1071/ 1111	1171/ 1211	1271/ 1311	1371/ 1411	1471/ 1511	1571/ 1611	1671/ 1711	1771/ 1811	1871/ 1911	1971/ 2011
Height of hole in wall	2073	2073	2073	2073	2073	2073	2073	2073	2073	2073	2073	2073	2073
Tunnel exterior height	2053	2053	2053	2053	2053	2053	2053	2053	2053	2053	2053	2053	2053
Tunnel clear height	2031	2031	2031	2031	2031	2031	2031	2031	2031	2031	2031	2031	2031
Tunnel covering height Adj. cover list 6 cm/Adj. cover list 8 cm	2102/ 2122	2102/ 2122	2102/ 2122	2102/ 2122	2102/ 2122	2102/ 2122	2102/ 2122	2102/ 2122	2102/ 2122	2102/ 2122	2102/ 2122	2102/ 2122	2102/ 2122



METAL FRAMES

TO BOARD AND STILE DOORS

ADJUSTABLE METAL FRAME (EMBRACING), metal sheet 1.5 mm thick

welded and painted in RAL 9010, 9016, 8003, 8017, 7016, 7047, 1001

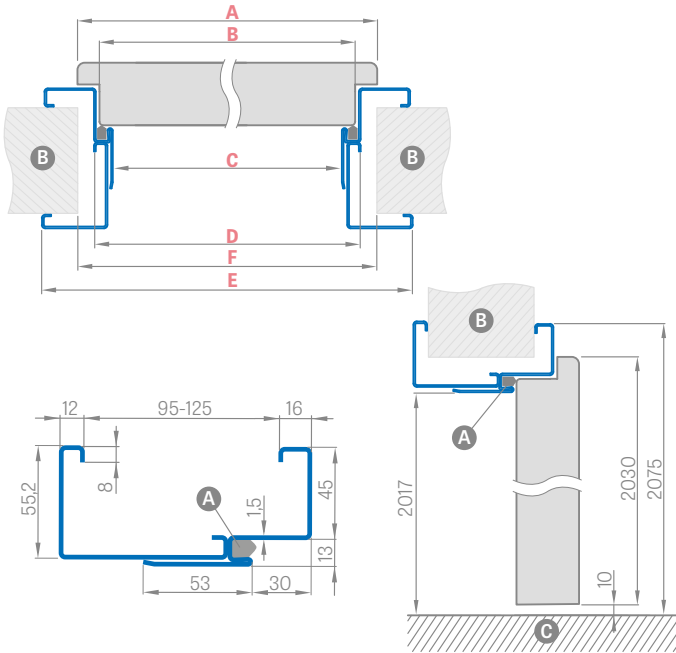

METAL SQUARE FRAME, LARGE SIZE, metal sheet 1.2 mm thick

welded and painted in RAL 9010, 9016, 8003, 8017, 7016, 7047, 1001

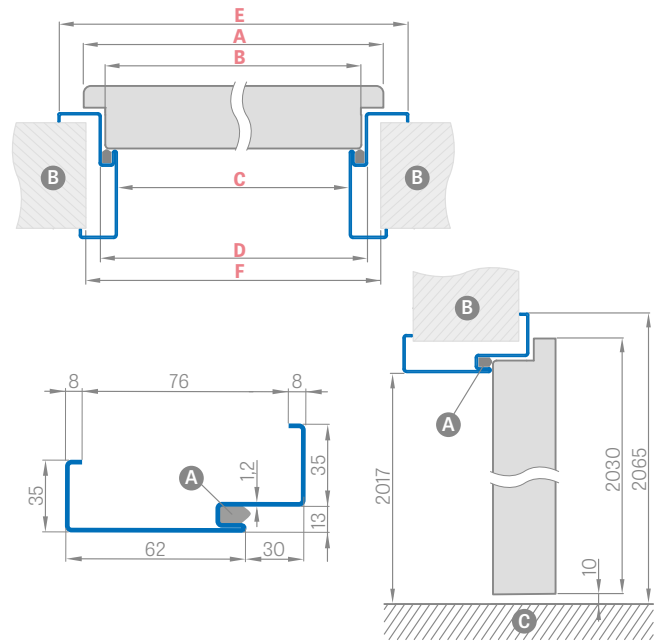

Width of door leaf	A	B	C	D	E	F
„60”	644	617	601	627	717	695
„70”	744	717	701	727	817	795
„80”	844	817	801	827	917	895
„90”	944	917	901	927	1017	995
„100”	1044	1017	1001	1027	1117	1095

Width of door leaf	A	B	C	D	E	F
„60”	644	617	601	627	697	683
„70”	744	717	701	727	797	783
„80”	844	817	801	827	897	883
„90”	944	917	901	927	997	983
„100”	1044	1017	1001	1027	1097	1083

Adjustment range min.max. (mm)
95-125
125-155
155-185
185-215
215-245
245-275
275-305

LAUNCHING OF CORNER FRAME

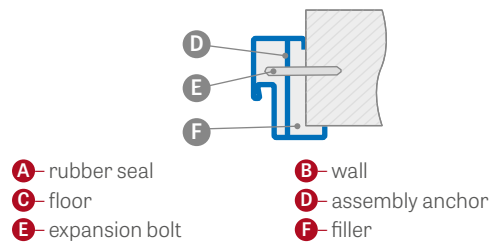

ADDITIONAL CHARGES

- electric strike
- enforcement for self-lock
- finishing with galvanised steel
- adjustable frame 100
- fixed frame 100
- double doors frame
- individual quotation

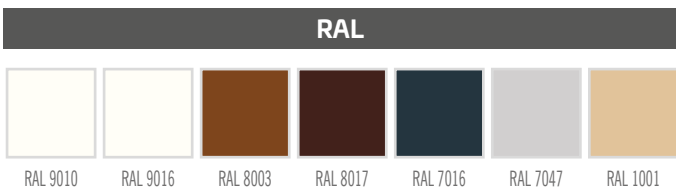

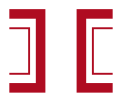

ADJUSTABLE FRAME CASING

TO STEEL FRAME

LOCATION OF DOOR KNOB IN FRAME CASING

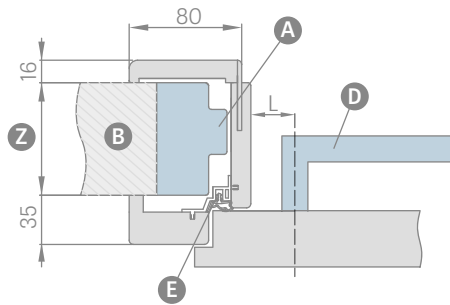

L - distance from knob axis to frame edge

L = 23 mm for board doors, ASTRA door knobs page 78

L = 28 mm for STILE doors (all door knobs METAL-BUD, ERKADO, HOPPE, TUPAI i GAMET page 74-79)

ATTENTION:

Before applying the door knob please check dimensions of the door knob plate.

Casing frame of range above 205 mm consists of two elements and of range above 330 mm it consists of three elements

AVAILABLE WIDTHS OF FRAME CASINGS:

60 70 80 90 100

	Adjustment range min.-max (mm)
1 element	80-105
	105-130
	130-155
	155-180
	180-205
2 elements	205-230
	230-255
	255-280
	280-305
	305-330
3 elements	330-355
	355-380
	380-405
	405-430
	430-455

TECHNICAL PICTURE OF FRAME CASING

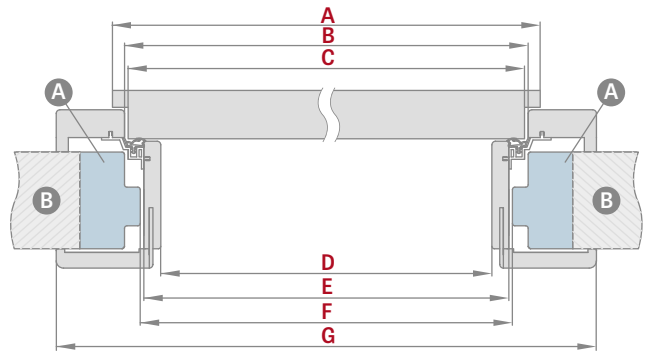

Width of door leaf	A	B	C	D	E	F	G
„60”	644	624	618	564	592	598	737
„70”	744	724	718	664	692	698	837
„80”	844	824	818	764	792	798	937
„90”	944	924	918	864	892	898	1037
„100”	1044	1024	1018	964	992	998	1137

F – minimal dimension of clear steel frame width on which we install frame casing. This dimension can be bigger than recommended by max. 20 mm. With bigger clear width one should pay attention whether the trims can properly cover the walls.

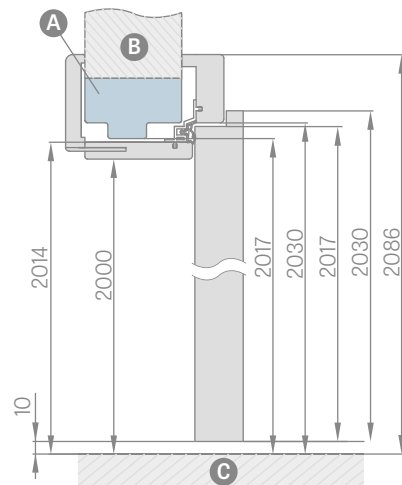

- A** – steel frame
- B** – wall
- C** – floor
- D** – knob
- E** – aluminium profile with gasket
- Z** – zakres od 80 mm do 255 mm

- Casing frames are not available for LAK decors
- Square with extended feather - not available
- Prices of tunnel frames of widths: 60, 70, 80, 90, 100 are at prices of casing frames
- Tunnel has the same dimensions as casing frame (there are no drills for hinge and lock plate however it is equipped with the seal)



ADJUSTABLE FRAME

NON-REBATED DOOR LEAFS

ADJUSTABLE FRAME RANGE 80-95 mm

Adj. cover list 6 cm / Adj. cover list 8 cm

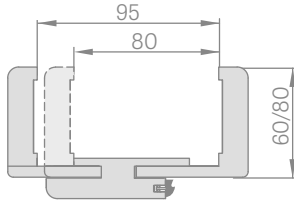

In the frame of range 80-95mm the feather of the square should be trimmed individually by the Customer to desired dimension.

FRAME CONNECTION

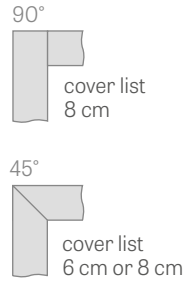

TECHNICAL PICTURE OF ADJUSTABLE FRAME

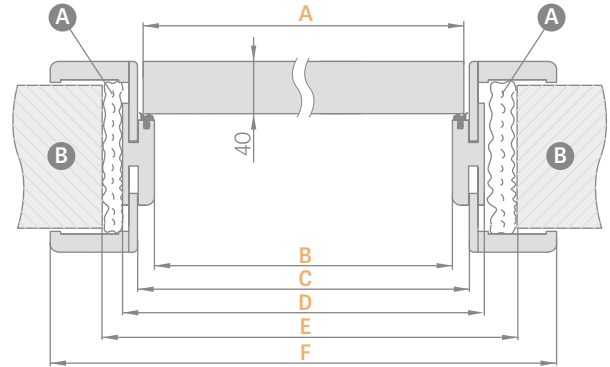

ADJUSTABLE FRAME ADJUSTMENT RANGE

Adj. cover list 6 cm / Adj. cover list 8 cm

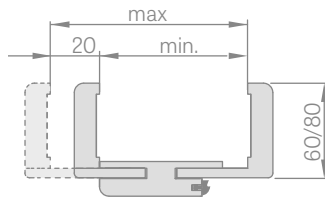

Width of door leaf	A	B	C	D	E	F
„60“	644	629	651	673	723	771*/811**
„70“	744	729	751	773	823	871*/911**
„80“	844	829	851	873	923	971*/1011**
„90“	944	929	951	973	1023	1071*/1111**
„100“	1044	1029	1051	1073	1123	1171*/1211**

* Adj. cover list 6 cm/ **Adj. cover list 8 cm

	Adjustment range min.-max (mm)
1 element	80-95
	95-115
	115-135
	135-155
	155-175
	175-195
	195-215
2 elements	215-235
	235-255
	255-275
	275-295
	295-315
	315-335
	335-355
	355-375
	375-395
	395-415

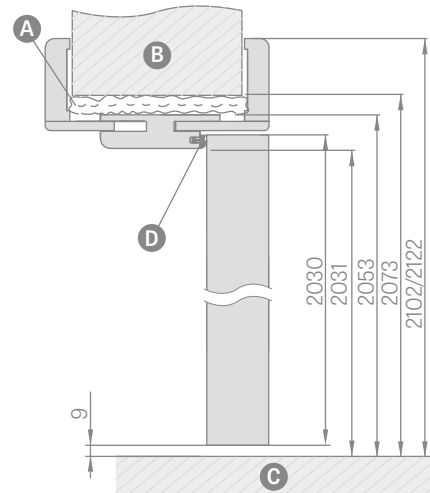

A mounting foam B wall C floor D rubber seal

- Connecting the adjustable frame to an angle of 90 degrees is possible only with the list cover 8 cm thick
- Adjustable frame of range more than 295 mm consists of two elements
- Mobile square with prolonged feather by 2 cm and standard square to adjustable frame comes in all available colours
- Prices of tunnel type of frame of widths: 60, 70, 80, 90, 100 are at the prices of adjustable frame for rebated doors
- Prices of tunnel type of frame of widths: 110, 120, 130, 140, 150, 160, 170, 180, 190 are at the prices of adjustable frame to rebated double doors.

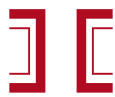

FIXED FRAME

REBATED DOOR LEAFS

FIXED FRAME SOFT TECHNOLOGY



TECHNICAL PICTURE OF FIXED FRAME

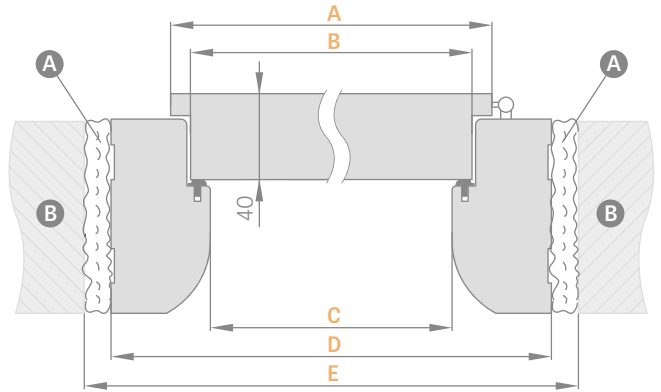

MASKING TRIM

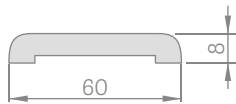

Width of door leaf	A	B	C	D	E
„60”	644	618	604	692	722
„70”	744	718	704	792	822
„80”	844	818	804	892	922
„90”	944	918	904	992	1022
„100”	1044	1018	1004	1092	1122

QUARTER ROUND

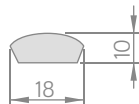

SKIRTING BOARD length 2.40 L.M.

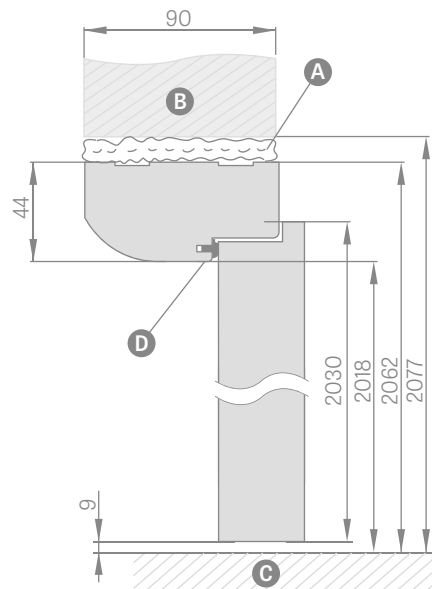
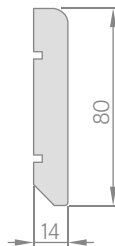

A mounting foam **B** wall **C** floor **D** rubber seal

- Skirting board is made of humidity resistant MDF. It comes in: WHITE GREKO, NUT GREKO, WHITE and PREMIUM decors as well as in baselayer ready to be painted.
- Assembly - it works on the glue

- Fixed non-rebated door frame - not applicable



ADJUSTABLE FRAME

REBATED DOOR LEAFS



Adjustable frame
Of range more than 280 mm

Adjustable frame* of range more than 280 mm consists of two elements
Adjustable frame* of range more than 400 mm consists of three elements
**concerns STANDARD, SOFT and STILE doors

ADJUSTMENT RANGE

Adj. cover list 6 cm / Adj. cover list 8 cm

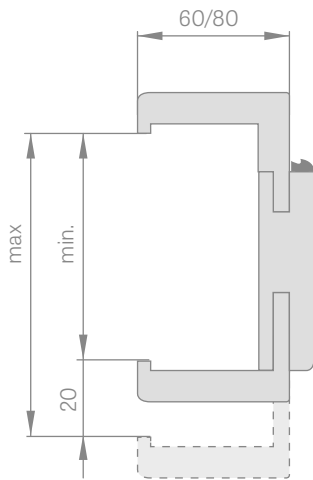

FRAME CONNECTION

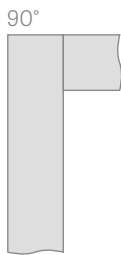

cover list
8 cm

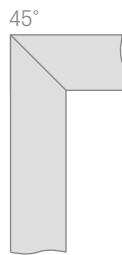

cover list
6 cm or 8 cm

TECHNICAL PICTURE OF ADJUSTABLE FRAME

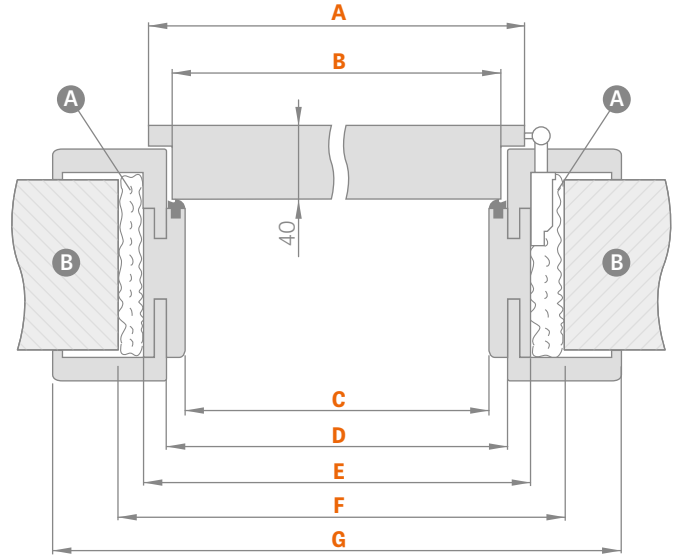

Width of door leaf	A	B	C	D	E	F	G
„60“	644	618	604	626	648	688	746*/786**
„70“	744	718	704	726	748	788	846*/886**
„80“	844	818	804	826	848	888	946*/986**
„90“	944	918	904	926	948	988	1046*/1086**
„100“	1044	1018	1004	1026	1048	1088	1146*/1186**

*adj. cover list 6 cm/ **adj. cover list 8 cm

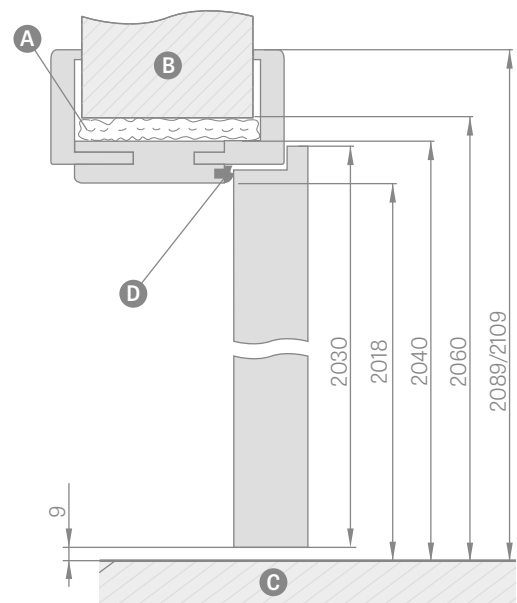

A mounting foam **B** wall **C** floor **D** rubber seal

Adjustment range min.max. (mm)	
1 element	80-100
	100-120
	120-140
	140-160
	160-180
	180-200
	200-220
	220-240
	240-260
	260-280
2 elements	260-300
	280-300
	300-320
	320-340
	340-360
	360-380
3 elements	380-400
	400-420

- Connecting the adjustable frame to an angle of 90 degrees is possible only with the list cover 8 cm thick
- Mobile square with prolonged feather by 2 cm and standard square to adjustable frame come in all available colours
- It is possible to make frames up to range 500-520 mm
- Prices of tunnel type of frame of widths: 60, 70, 80, 90, 100 are at the prices of adjustable frame for rebated doors
- Prices of tunnel type of frame (for rebated and non-rebated leafs) of widths: 110, 120, 130, 140, 150, 160, 170, 180, 190 are at the prices of adjustable frame to rebated double doors.



ERKADO Zbigniew Kozłowski

Gościeradów-Folwark Osiedle POM 8

23-275 Gościeradów

TAX NO 865-118-29-63

e-mail: biuro@erkado.pl

www.erkado.pl

POLAND

INTERIOR DOORS

tel. +48 15/ 838 10 57

fax +48 15/ 838 18 84

EXTERIOR DOORS

tel. +48 15/ 845 33 88

fax +48 15/ 845 34 05

www.erkado.pl

The guarantee and assembly cards are attached to the product.

This catalogue is only of the informative usage and includes up-to-date range of available products.

The producer has the right to change the prices and the range of available goods without official notification.

The colour samples can differ in reality with those presented in this catalogue. Please consult the colours with the original samples that can be accessed at our distributors.

We have the right to printing errors.

This catalogue does not constitute an offer, in the context of law and is published only for the informative purposes.

Technical certificates can be accessed and downloaded from our website www.erkado.pl

The choice of proper door leafs should be based on the technical project of the given space/room, worked upon with consideration of all legal housing norms and regulations being in law.

ERKADO offers several possibilities however the choice is left to the Purchaser due to the fact that only the Purchaser or person operating on Its behalf knows the purpose and exploitation conditions of the ordered product.



Scan code and download this catalogue
on to Your smartphone/tablet [pdf]