

INTERIOR DOORS

2019





Dear Partners and Clients,

I would like to express my gratitude for Your trust and loyalty to Erkado brand. Also, I am proud to realise the fact You greatly enjoy our offer.

It is exactly thanks to Your strong feedback, knowledge of the market and involvement that together we can navigate the trends when it comes to the production of interior and exterior doors. Your support is a priceless asset to us and I want to thank again. With every edition of the catalogue we discover and become more aware of the fact that the functionality of doors is only of the aspects. There is more to it and I can say it is the design and innovative solutions.

It is of utmost importance to have Your trust, to share responsible work policy and cooperate in loyal terms.

For more than forty years we have managed the company in an ambitious and flexible way. The result is a strong, dynamic growth that motivates us to take up daring investments. One of them is to expand the production area by 20 000 m² (45 000 m² currently existing) till the end of 2019.

All this happens thanks to You and for You that is why, I feel honest pleasure to present to You the newest edition of the catalogue - effect of joint passion to doors.

Yours sincerely,

Zbigniew Kozłowski



The mark of responsible forestry
Look for FSC® certified products

CONTENTS

STILE DOORS	6
ARALIA	6
EWODIA	8
NOLINA	10
LAURENCJA NEW	12
SURMIA NEW	14
BUDLEJA NEW	16
EPIMEDIUM NEW	18
POWOJNIK NEW	20
MAGNOLIA	22
JUKA BEST PRICE!	24
FORSYCJA BEST PRICE!	26
LAWENDA BEST PRICE!	28
IRYS	30
DAGLEZJA	32
FREZJA NEW	34
DEBECJA	36
NEMEZJA NEW	38
BERBERYS	40
FLOKS	42
KROKUS	44
KAMELIA	46
PETUNIA	48
AZALIA	50
HIACYNT	52
FRAGI	54
GRAF GLASS DOORS	56
PAINTED DOORS	58
UNO PREMIUM NEW	58
TURAN NEW	60
MILDA NEW	62
BALDUR NEW	64
ANUBIS NEW	66
SYLENA NEW	68
BOARD DOORS	70
UNO PREMIUM	70
UNO LUX	74
BALDUR NEW	76
ALTAMURA NEW	78
ANSEDONIA NEW	80
LORIENT NEW	82
MENTON NEW	84
SORANO NEW	86
INTERIOR ENTRANCE DOORS	88
FORTECA RC2 NEW	90
FORTECA RC3 NEW	92
HERSE SET	94
HERSE LUX SET	96
HERSE MAX SET	98
FIXED AND ADJUSTABLE DOOR FRAMES TO HERSE SET	100
METAL DOOR FRAMES TO HERSE SET	102
INTERIOR FIRE RESISTANT DOORS	103
LEDA EI30	103
LEDA EI60	103
WOODEN DOOR FRAME TO LEDA	104
METAL DOOR FRAMES TO LEDA	105
HARDWARE – DOOR KNOBS NEW	106
TECHNICAL INFORMATION	113
ON-WALL SLIDING SYSTEM NEW	119
IN-WALL SLIDING SYSTEM	125
DOUBLE DOORS	128
FOLDING DOORS NEW	131
HIDDEN DOORS SYSTEM	132
TRANSOMS	135
DOOR FRAMES	137
ADJUSTABLE FRAME TUNNEL TYPE	140
METAL DOOR FRAMES	141
ADJUSTABLE CASING FRAME TO IRON FRAMES	142
REVERSE FRAME NEW	143
ADJUSTABLE FRAME TO NON-REBATED DOOR LEAF	144
FIXED FRAME TO REBATED DOOR LEAF	145
ADJUSTABLE FRAME TO REBATED DOOR LEAF	146



DECORS

DECORS AVAILABLE FOR INTERIOR DOORS

GREKO, FINISH



GOLDEN OAK GREKO

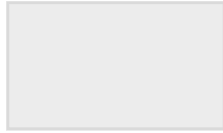

WHITE GREKO



ELM GREKO



GREY OAK GREKO



SANREMO GREKO



WALNUT GREKO



OAK GREKO



MEDIUM OAK GREKO



SONOMA GREKO



WHITE PINE GREKO



BRIGHT WHITE GREKO



WALNUT FINISH



ACACIA FINISH



BRIGHT ACACIA FINISH

PREMIUM



WALNUT PREMIUM



GREY MAPLE PREMIUM



OAK PREMIUM

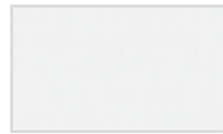

WHITE BARK PREMIUM

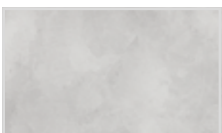

CONCRETE PREMIUM



DIAGONAL LARCH



GRAPHITE ASH PREMIUM

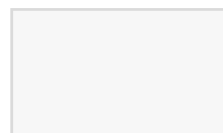

WHITE PREMIUM

SOFT PCV



VENGE TWIN



GOLDEN OAK TWIN

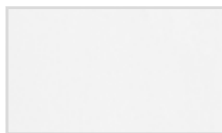

WHITE TWIN



MIDDLE WALNUT TWIN

CPL



OAK ST CPL



GREY OAK ST CPL



VENGE ST CPL



GREY PINE ST CPL
(available from 1st Apr.2019)



STILE INTERIOR DOORS

REBATED AND NON-REBATED



Solid rail 35 mm or 22 mm thick



Esthetic profiled non-rail glazing



Unusual GREKO foil, resistant CPL foil or PREMIUM foil that combines unique structure with practical features



Modern tempered glass; milk and transparent or innovative VSG matt glass



Three regulated hinges set in massive vertical rail 40 mm thick



Solid tenon connections



MDF rail for GREKO foils



Wooden rail for PREMIUM and CPL foil
- core made of layer plywood



ARALIA



REBATED AND NON-REBATED INTERIOR STILE DOOR LEAFS



ARALIA 2
WHITE BARK PREMIUM, FUTURA INOX door knob



ARALIA 1



ARALIA 2



ARALIA 3



Presented model: ARALIA 1 in WHITE BARK PREMIUM decor with FUTURA INOX door knob



CONSTRUCTION

- rebated or non-rebated door leaf made in STILE technology
- vertical wooden rails covered with thin HDF in PREMIUM decors
- HDF boards 16mm thick covered with PREMIUM decor (vertical grain)

HARDWARE

- rebated door leaves: three silver pintle hinges regulated horizontally, bolt lock
- non-rebated door leaves: three hidden hinges regulated in three planes, magnetic lock, cylinder lock, economy lock or bathroom lock

GLAZING

- milk decormat glass or VSG 221 security type of glass, smooth on both sides
- possibility to modify glazing for REVERSE (OBVERSE in standard glazing)

AVAILABLE SOLUTIONS (page 119-130)

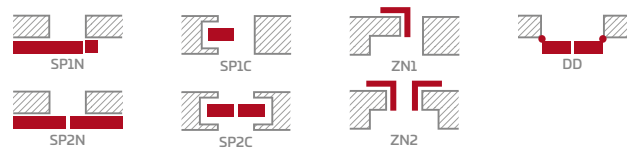

AVAILABLE DOOR WIDTHS

60 70 80 90 100

ADDITIONAL CHARGES

ventilation cut

plastic ventilation sleeves (4 pieces)

metal ventilation grill round and square (4 pieces);
finishing: brushed nickel or patina, white and black

ventilation grill (only for door leaves in widths: 80, 90, 100)

rebated and non-rebated door leaf 100 wide

VSG 221 security type of glass, smooth on both sides

metal hinge casings for rebated door leaf
colour: brushed nickel, patina, polished chrome, polished brass,
white and black

automatic door seal

PREMIUM



WALNUT
PREMIUM



GREY MAPLE
PREMIUM

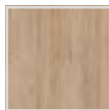

OAK PREMIUM



WHITE BARK
PREMIUM



GRAPHITE ASH
PREMIUM



Wooden rail for PREMIUM
and CPL decors



EWODIA



REBATED AND NON-REBATED INTERIOR STILE DOOR LEAFS



EWODIA 4
OAK PREMIUM, LUNA PREMIUM door knob



EWODIA 1



EWODIA 2



EWODIA 3



EWODIA 4

Presented model: EWODIA 1 in OAK PREMIUM decor with LUNA PREMIUM door knob



CONSTRUCTION

- rebated or non-rebated door leaf made in STILE technology
- vertical wooden rails covered with thin HDF in PREMIUM decors
- HDF boards 16mm thick covered with PREMIUM decor (vertical grain)

HARDWARE

- rebated door leaves: three silver pintle hinges regulated horizontally, bolt lock
- non-rebated door leaves: three hidden hinges regulated in three planes, magnetic lock, cylinder lock, economy lock or bathroom lock

GLAZING

- milk decormat glass or VSG 221 security type of glass, smooth on both sides
- possibility to modify glazing for REVERSE (OBVERSE in standard glazing)

AVAILABLE SOLUTIONS (page 119-130)

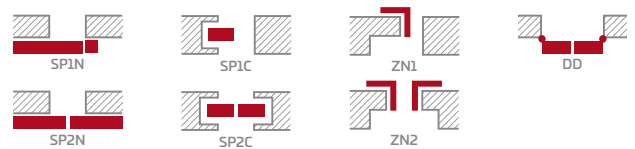

AVAILABLE DOOR WIDTHS

60 70 80 90 100

ADDITIONAL CHARGES

ventilation cut

plastic ventilation sleeves (4 pieces)

metal ventilation grill round and square (4 pieces);
finishing: brushed nickel or patina, white and black

ventilation grill (only for door leaves in widths: 80, 90, 100)

rebated and non-rebated door leaf 100 wide

VSG 221 security type of glass, smooth on both sides

metal hinge casings for rebated door leaf
colour: brushed nickel, patina, polished chrome, polished brass,
white and black

automatic door seal

PREMIUM



WALNUT
PREMIUM



GREY MAPLE
PREMIUM

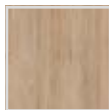

OAK PREMIUM

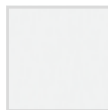

WHITE BARK
PREMIUM



GRAPHITE ASH
PREMIUM



Wooden rail for PREMIUM
and CPL decors

NOLINA



REBATED AND NON-REBATED INTERIOR STILE DOOR LEAFS



NOLINA 1
decor GREY MAPLE PREMIUM, FUTURA INOX door knob



NOLINA 1



NOLINA 2



NOLINA 3

Presented model: NOLINA 1 in GREY MAPLE PREMIUM decor with FUTURA INOX door knob



CONSTRUCTION

- rebated or non-rebated door leaf made in STILE technology
- vertical wooden rails covered with thin HDF in PREMIUM decors
- HDF boards 16mm thick covered with PREMIUM decor (vertical grain)

HARDWARE

- rebated door leaves: three silver pintle hinges regulated horizontally, bolt lock
- non-rebated door leaves: three hidden hinges regulated in three planes, magnetic lock, cylinder lock, economy lock or bathroom lock

GLAZING

- milk decormat glass or VSG 221 security type of glass, smooth on both sides
- possibility to modify glazing for REVERSE (OBVERSE in standard glazing)

AVAILABLE SOLUTIONS (page 119-130)

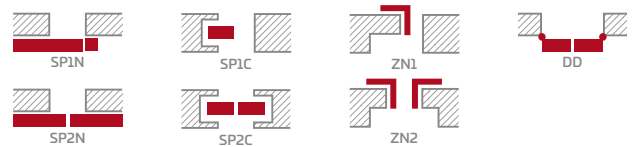

AVAILABLE DOOR WIDTHS

60 70 80 90 100

ADDITIONAL CHARGES

ventilation cut

plastic ventilation sleeves (4 pieces)

metal ventilation grill round and square (4 pieces);
finishing: brushed nickel or patina, white and black

ventilation grill (only for door leaves in widths: 80, 90, 100)

rebated and non-rebated door leaf 100 wide

VSG 221 security type of glass, smooth on both sides

metal hinge casings for rebated door leaf
colour: brushed nickel, patina, polished chrome, polished brass,
white and black

automatic door seal

PREMIUM

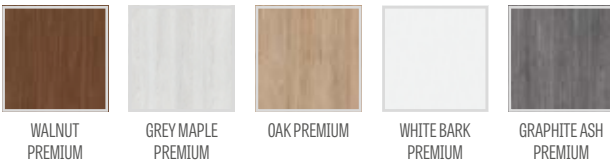

WALNUT
PREMIUM

GREY MAPLE
PREMIUM

OAK PREMIUM

WHITE BARK
PREMIUM

GRAPHITE ASH
PREMIUM



Wooden rail for PREMIUM
and CPL decors



LAURENCJA

NEW



REBATED AND NON-REBATED INTERIOR STILE DOOR LEAFS



LAURENCJA 1
decor WHITE PREMIUM, CUBE PREMIUM door knob



LAURENCJA 1



LAURENCJA 2



LAURENCJA 3



LAURENCJA 4



LAURENCJA 5



LAURENCJA 6



Presented model: LAURENCJA 1 in WHITE PREMIUM decor with CUBE PREMIUM door knob



CONSTRUCTION

- rebated or non-rebated door leaf made in STILE technology
- vertical wooden rails covered with thin HDF in PREMIUM or CPL decors
- HDF boards 4mm thick covered with CPL or PREMIUM decors
- very wide bar 35 mm thick

HARDWARE

- rebated door leaves: three silver pintle hinges regulated horizontally, bolt lock
- non-rebated door leaves: three hidden hinges regulated in three planes, magnetic lock, cylinder lock, economy lock or bathroom lock

GLAZING

- milk or transparent hardened glass fixed in standard or VSG 221 security type of glass, smooth on both sides additionally charged
- possibility to modify glazing for REVERSE (OBVERSE in standard glazing)

AVAILABLE SOLUTIONS (page 119-130)

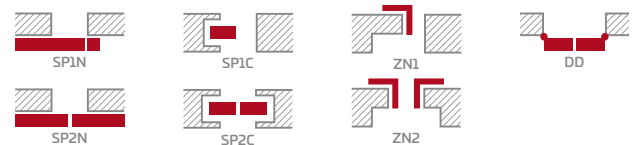

AVAILABLE DOOR WIDTHS

60 70 80 90 100

ADDITIONAL CHARGES

ventilation cut

plastic ventilation sleeves (4 pieces)

metal ventilation grill round and square (4 pieces);
finishing: brushed nickel or patina, white and black

ventilation grill (only for door leaves in widths: 80, 90, 100)

rebated and non-rebated door leaf 100 wide

VSG 221 security type of glass, smooth on both sides

metal hinge casings for rebated door leaf
colour: brushed nickel, patina, polished chrome, polished brass,
white and black

automatic door seal

PREMIUM

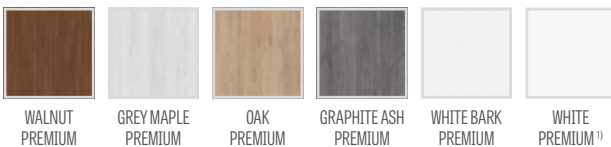

CPL



Wooden rail for PREMIUM and CPL decors

¹⁾ white foil imitating painting surface

²⁾ available from 1st April 2019



SURMIA

NEW



REBATED AND NON-REBATED INTERIOR STILE DOOR LEAFS



SURMIA 1
decor OLD VENGE CPL, CUBE door knob



SURMIA 1



SURMIA 2



SURMIA 3



SURMIA 4



Presented model: SURMIA 1 in OLD VENGE CPL decor with CUBE door knob



CONSTRUCTION

- rebated or non-rebated door leaf made in STILE technology
- vertical wooden rails covered with thin HDF in PREMIUM or CPL decors
- HDF boards 22mm and 4mm thick covered with CPL or PREMIUM decors
- very wide bar 35 mm thick

HARDWARE

- rebated door leaves: three silver pintle hinges regulated horizontally, bolt lock
- non-rebated door leaves: three hidden hinges regulated in three planes, magnetic lock, cylinder lock, economy lock or bathroom lock

GLAZING

- milk or transparent hardened glass fixed in standard or VSG 221 security type of glass, smooth on both sides additionally charged
- possibility to modify glazing for REVERSE (OBVERSE in standard glazing)

AVAILABLE SOLUTIONS (page 119-130)

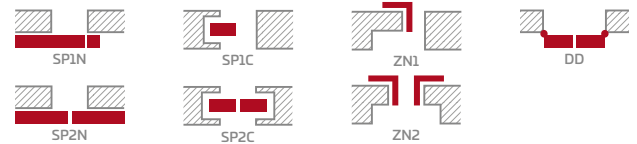

AVAILABLE DOOR WIDTHS

60 70 80 90 100

ADDITIONAL CHARGES

ventilation cut

plastic ventilation sleeves (4 pieces)

metal ventilation grill round and square (4 pieces);
finishing: brushed nickel or patina, white and black

ventilation grill (only for door leaves in widths: 80, 90, 100)

rebated and non-rebated door leaf 100 wide

VSG 221 security type of glass, smooth on both sides

metal hinge casings for rebated door leaf
colour: brushed nickel, patina, polished chrome, polished brass,
white and black

automatic door seal

PREMIUM

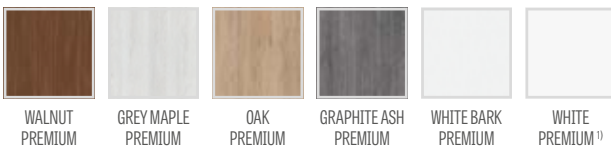

CPL



Wooden rail for PREMIUM and CPL decors

¹⁾ white foil imitating painting surface

²⁾ available from 1st April 2019



BUDLEJA

NEW



REBATED AND NON-REBATED INTERIOR STILE DOOR LEAFS



BUDLEJA 2
decor OAK ST CPL, FUTURA INOX door knob



BUDLEJA 1



BUDLEJA 2



BUDLEJA 3



BUDLEJA 4



BUDLEJA 5



BUDLEJA 6



BUDLEJA 7



BUDLEJA 8



Presented model: BUDLEJA 1 in OAK ST CPL decor with FUTURA INOX door knob



CONSTRUCTION

- rebated or non-rebated door leaf made in STILE technology
- vertical wooden rails covered with thin HDF in PREMIUM or CPL decors
- very wide bar 35 mm thick

HARDWARE

- rebated door leaves: three silver pintle hinges regulated horizontally, bolt lock
- non-rebated door leaves: three hidden hinges regulated in three planes, magnetic lock, cylinder lock, economy lock or bathroom lock

GLAZING

- milk or transparent hardened glass fixed in standard or VSG 221 security type of glass, smooth on both sides additionally charged
- possibility to modify glazing for REVERSE (OBVERSE in standard glazing)

AVAILABLE SOLUTIONS (page 119-130)

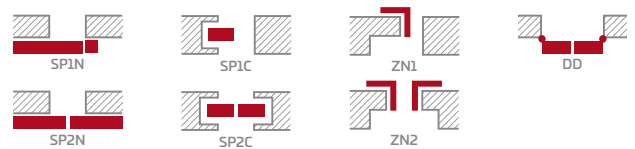

AVAILABLE DOOR WIDTHS

60 70 80 90 100

ADDITIONAL CHARGES

ventilation cut

plastic ventilation sleeves (4 pieces)

metal ventilation grill round and square (4 pieces);
finishing: brushed nickel or patina, white and black

ventilation grill (only for door leaves in widths: 80, 90, 100)

rebated and non-rebated door leaf 100 wide

VSG 221 security type of glass, smooth on both sides

metal hinge casings for rebated door leaf
colour: brushed nickel, patina, polished chrome, polished brass,
white and black

automatic door seal

PREMIUM

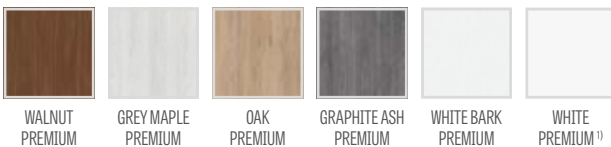

CPL



Wooden rail for PREMIUM
and CPL decors

¹⁾ white foil imitating painting surface

²⁾ available from 1st April 2019

EPIMEDIUM

NEW



REBATED AND NON-REBATED INTERIOR STILE DOOR LEAFS



EPIMEDIUM 4
decor GRAPHITE ASH PREMIUM, CUBE door knob



EPIMEDIUM 1 *)



EPIMEDIUM 2 *)



EPIMEDIUM 3 *)



EPIMEDIUM 4 *)



EPIMEDIUM 5 *)

*) Presented photos of EPIMEDIUM model concern only door leaf 80 wide. In other widths there are differences in proportion of glass towards vertical bars. The graphics showing particular widths can be found on www.erkado.pl

Presented model: EPIMEDIUM 1 in GRAPHITE ASH PREMIUM decor with CUBE door knob



GREKO



PREMIUM

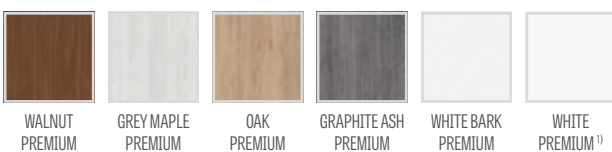

CPL



MDF rail for GREKO foils



Wooden rail for PREMIUM and CPL decors

CONSTRUCTION

- rebated or non-rebated door leaf made in STILE technology
- MDF rails in GREKO decors or vertical wooden rails covered with thin HDF in PREMIUM or CPL decors
- HDF boards 4mm thick covered with GREKO, CPL or PREMIUM decor
- long narrow bar 22mm thick

HARDWARE

- rebated door leaves: three silver pintle hinges regulated horizontally, bolt lock
- non-rebated door leaves: three hidden hinges regulated in three planes, magnetic lock, cylinder lock, economy lock or bathroom lock

GLAZING

- milk or transparent hardened glass fixed in standard or VSG 221 security type of glass, smooth on both sides additionally charged
- possibility to modify glazing for REVERSE (OBVERSE in standard glazing)

AVAILABLE SOLUTIONS (page 119-130)

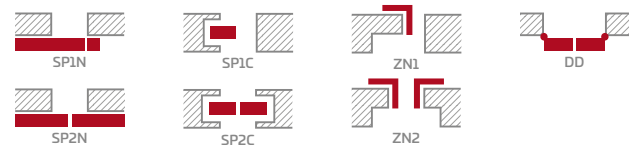

AVAILABLE DOOR WIDTHS



ADDITIONAL CHARGES

ventilation cut

plastic ventilation sleeves (4 pieces)

metal ventilation grill round and square (4 pieces); finishing: brushed nickel or patina, white and black

ventilation grill (only for door leaves in widths: 80, 90, 100)

rebated and non-rebated door leaf 100 wide

VSG 221 security type of glass, smooth on both sides

metal hinge casings for rebated door leaf colour: brushed nickel, patina, polished chrome, polished brass, white and black

automatic door seal

¹⁾ white foil imitating painting surface

²⁾ available from 1st April 2019



POWOJNIK

NEW



REBATED AND NON-REBATED INTERIOR STILE DOOR LEAFS



POWOJNIK 5
decor GREY OAK ST CPL, FUTURA INOX door knob



POWOJNIK 1



POWOJNIK 2



POWOJNIK 3



POWOJNIK 4



POWOJNIK 5



Presented model: POWOJNIK 1 in GREY OAK ST CPL decor with FUTURA INOX door knob



CONSTRUCTION

- rebated or non-rebated door leaf made in STILE technology
- vertical wooden rails covered with thin HDF in PREMIUM or CPL decors
- HDF boards 4mm thick covered with CPL or PREMIUM decors
- central bars 22mm thick and very wide upper and bottom bar 35mm thick

HARDWARE

- rebated door leaves: three silver pintle hinges regulated horizontally, bolt lock
- non-rebated door leaves: three hidden hinges regulated in three planes, magnetic lock, cylinder lock, economy lock or bathroom lock

GLAZING

- milk or transparent hardened glass fixed in standard or VSG 221 security type of glass, smooth on both sides additionally charged
- possibility to modify glazing for REVERSE (OBVERSE in standard glazing)

AVAILABLE SOLUTIONS (page 119-130)

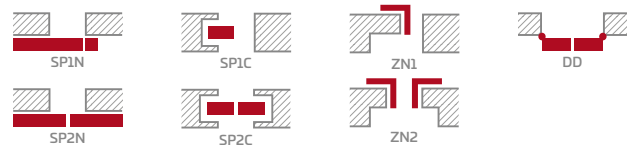

AVAILABLE DOOR WIDTHS



ADDITIONAL CHARGES

ventilation cut

plastic ventilation sleeves (4 pieces)

metal ventilation grill round and square (4 pieces);
finishing: brushed nickel or patina, white and black

ventilation grill (only for door leaves in widths: 80, 90, 100)

rebated and non-rebated door leaf 100 wide

VSG 221 security type of glass, smooth on both sides

metal hinge casings for rebated door leaf
colour: brushed nickel, patina, polished chrome, polished brass,
white and black

automatic door seal

PREMIUM

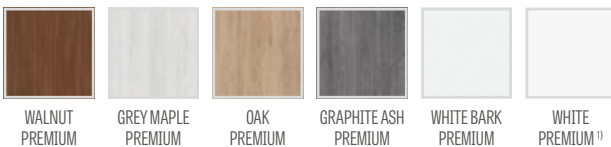

CPL



Wooden rail for PREMIUM and CPL decors

¹⁾ white foil imitating painting surface

²⁾ available from 1st April 2019



MAGNOLIA



REBATED AND NON-REBATED INTERIOR STILE DOOR LEAFS



MAGNOLIA 1
decor WALNUT GREKO, DECO door knob



MAGNOLIA 1



MAGNOLIA 2



MAGNOLIA 3



MAGNOLIA 4



MAGNOLIA 5



MAGNOLIA 6



MAGNOLIA 7



MAGNOLIA 8



Presented model: MAGNOLIA 1 in WALNUT GREKO decor with DECO door knob



CONSTRUCTION

- rebated or non-rebated door leaf made in STILE technology
- MDF rails covered in GREKO decors and vertical wooden rails covered with thin HDF in PREMIUM or CPL decors
- HDF boards 4mm thick covered with GREKO, CPL or PREMIUM decors

HARDWARE

- rebated door leaves: three silver pintle hinges regulated horizontally, bolt lock
- non-rebated door leaves: three hidden hinges regulated in three planes, magnetic lock, cylinder lock, economy lock or bathroom lock

GLAZING

- milk or transparent hardened glass fixed in standard or VSG 221 security type of glass, smooth on both sides additionally charged
- possibility to modify glazing for REVERSE (OBVERSE in standard glazing)

AVAILABLE SOLUTIONS (page 119-130)

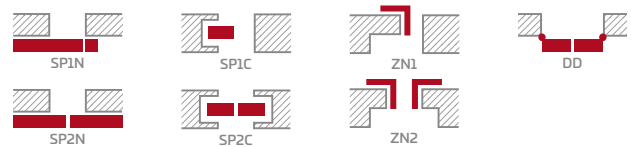

AVAILABLE DOOR WIDTHS

60 70 80 90 100

ADDITIONAL CHARGES

ventilation cut

plastic ventilation sleeves (4 pieces)

metal ventilation grill round and square (4 pieces);
finishing: brushed nickel or patina, white and black

ventilation grill (only for door leaves in widths: 80, 90, 100)

rebated and non-rebated door leaf 100 wide

VSG 221 security type of glass, smooth on both sides

metal hinge casings for rebated door leaf
colour: brushed nickel, patina, polished chrome, polished brass,
white and black

automatic door seal

GREKO



PREMIUM

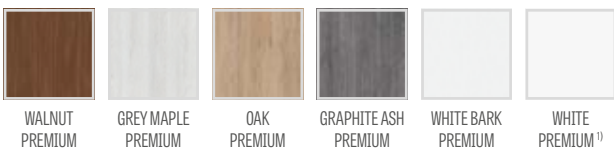

CPL



MDF rail for GREKO foils



Wooden rail for PREMIUM and CPL decors

¹⁾ white foil imitating painting surface

²⁾ vertical rails in WHITE GREKO decor, vertical elements and boards in WALNUT GREKO decor

³⁾ available from 1st April 2019



JUKA

BEST PRICE!



REBATED AND NON-REBATED INTERIOR STILE DOOR LEAFS



JUKA 4
decor MEDIUM OAK GREKO, FUTURA INOX door knob



JUKA 1



JUKA 2



JUKA 3



JUKA 4



JUKA 5



JUKA 6



JUKA 7



JUKA 8



Presented model: JUKA 1 in MEDIUM OAK GREKO decor with FUTURA INOX door knob



GREKO



PREMIUM

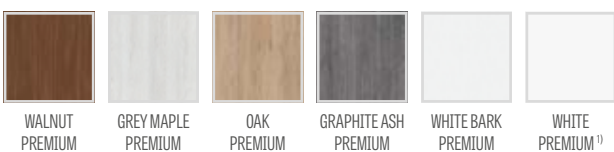

CPL



MDF rail for GREKO foils



Wooden rail for PREMIUM and CPL decors

CONSTRUCTION

- rebated or non-rebated door leaf made in STILE technology
- MDF rails covered in GREKO decors and vertical wooden rails covered with thin HDF in PREMIUM or CPL decors
- HDF boards 4mm thick covered with GREKO, CPL or PREMIUM decors

HARDWARE

- rebated door leaves: three silver pintle hinges regulated horizontally, bolt lock
- non-rebated door leaves: three hidden hinges regulated in three planes, magnetic lock, cylinder lock, economy lock or bathroom lock

GLAZING

- milk or transparent hardened glass fixed in standard or VSG 221 security type of glass, smooth on both sides additionally charged
- possibility to modify glazing for REVERSE (OBVERSE in standard glazing)

AVAILABLE SOLUTIONS (page 119-130)

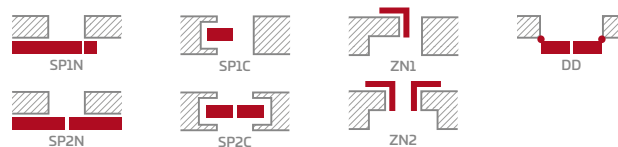

AVAILABLE DOOR WIDTHS



ADDITIONAL CHARGES

ventilation cut

plastic ventilation sleeves (4 pieces)

metal ventilation grill round and square (4 pieces); finishing: brushed nickel or patina, white and black

ventilation grill (only for door leaves in widths: 80, 90, 100)

rebated and non-rebated door leaf 100 wide

VSG 221 security type of glass, smooth on both sides

metal hinge casings for rebated door leaf
colour: brushed nickel, patina, polished chrome, polished brass, white and black

automatic door seal

¹⁾ white foil imitating painting surface

²⁾ available from 1st April 2019



FORSYCJA

BEST PRICE!



REBATED AND NON-REBATED INTERIOR STILE DOOR LEAFS



FORSYCJA 1
decor WHITE GREKO, TUPAI 2275 Q door knob



FORSYCJA 1



FORSYCJA 2



FORSYCJA 3



FORSYCJA 4



FORSYCJA 5



FORSYCJA 6



FORSYCJA 7



FORSYCJA 8



Presented model: FORSYCJA 4 in WHITE GREKO decor with TUPAI 2275 Q door knob



CONSTRUCTION

- rebated or non-rebated door leaf made in STILE technology
- MDF rails covered in GREKO decors and vertical wooden rails covered with thin HDF in PREMIUM or CPL decors
- HDF boards 4mm thick covered with GREKO, CPL or PREMIUM decors

HARDWARE

- rebated door leaves: three silver pintle hinges regulated horizontally, bolt lock
- non-rebated door leaves: three hidden hinges regulated in three planes, magnetic lock, cylinder lock, economy lock or bathroom lock

GLAZING

- milk or transparent hardened glass fixed in standard or VSG 221 security type of glass, smooth on both sides additionally charged
- possibility to modify glazing for REVERSE (OBVERSE in standard glazing)

AVAILABLE SOLUTIONS (page 119-130)

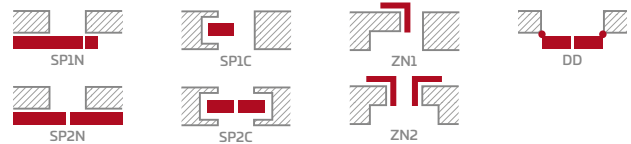

AVAILABLE DOOR WIDTHS

60 70 80 90 100

ADDITIONAL CHARGES

ventilation cut

plastic ventilation sleeves (4 pieces)

metal ventilation grill round and square (4 pieces);
finishing: brushed nickel or patina, white and black

ventilation grill (only for door leaves in widths: 80, 90, 100)

rebated and non-rebated door leaf 100 wide

VSG 221 security type of glass, smooth on both sides

metal hinge casings for rebated door leaf
colour: brushed nickel, patina, polished chrome, polished brass,
white and black

automatic door seal

GREKO



PREMIUM

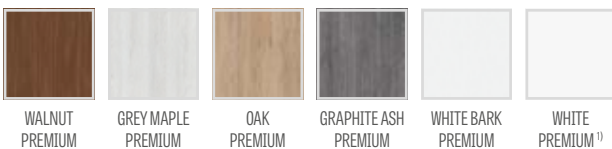

CPL



MDF rail for GREKO foils



Wooden rail for PREMIUM
and CPL decors

¹⁾ white foil imitating painting surface

²⁾ available from 1st April 2019

LAWENDA

BEST PRICE!



REBATED AND NON-REBATED INTERIOR STILE DOOR LEAFS



LAWENDA 7
decor OAK GREKO, DECO door knob



LAWENDA 1



LAWENDA 2



LAWENDA 3



LAWENDA 4



LAWENDA 5



LAWENDA 6



LAWENDA 7



LAWENDA 8



LAWENDA 9

Presented model: LAWENDA 1 in OAK GREKO decor with DECO door knob



CONSTRUCTION

- rebated or non-rebated door leaf made in STILE technology
- MDF rails covered in GREKO decors and vertical wooden rails covered with thin HDF in PREMIUM or CPL decors
- HDF boards 4mm thick covered with GREKO, CPL or PREMIUM decors

HARDWARE

- rebated door leaves: three silver pintle hinges regulated horizontally, bolt lock
- non-rebated door leaves: three hidden hinges regulated in three planes, magnetic lock, cylinder lock, economy lock or bathroom lock

GLAZING

- milk or transparent hardened glass fixed in standard or VSG 221 security type of glass, smooth on both sides additionally charged
- possibility to modify glazing for REVERSE (OBVERSE in standard glazing)

AVAILABLE SOLUTIONS (page 119-130)

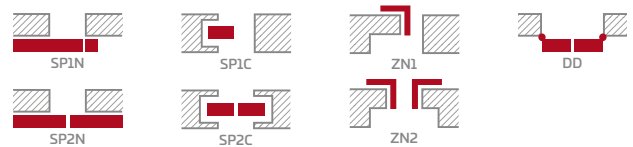

AVAILABLE DOOR WIDTHS

60 70 80 90 100

ADDITIONAL CHARGES

ventilation cut

plastic ventilation sleeves (4 pieces)

metal ventilation grill round and square (4 pieces);
finishing: brushed nickel or patina, white and black

ventilation grill (only for door leaves in widths: 80, 90, 100)

rebated and non-rebated door leaf 100 wide

VSG 221 security type of glass, smooth on both sides

metal hinge casings for rebated door leaf
colour: brushed nickel, patina, polished chrome, polished brass,
white and black

automatic door seal

GREKO



PREMIUM

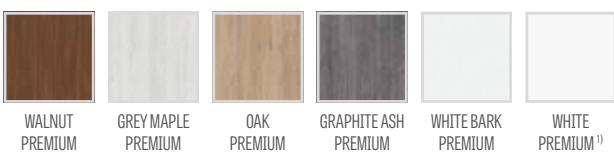

CPL



MDF rail for GREKO foils



Wooden rail for PREMIUM and CPL decors

¹⁾ white foil imitating painting surface

²⁾ available from 1st April 2019



IRYS



REBATED AND NON-REBATED INTERIOR STILE DOOR LEAFS

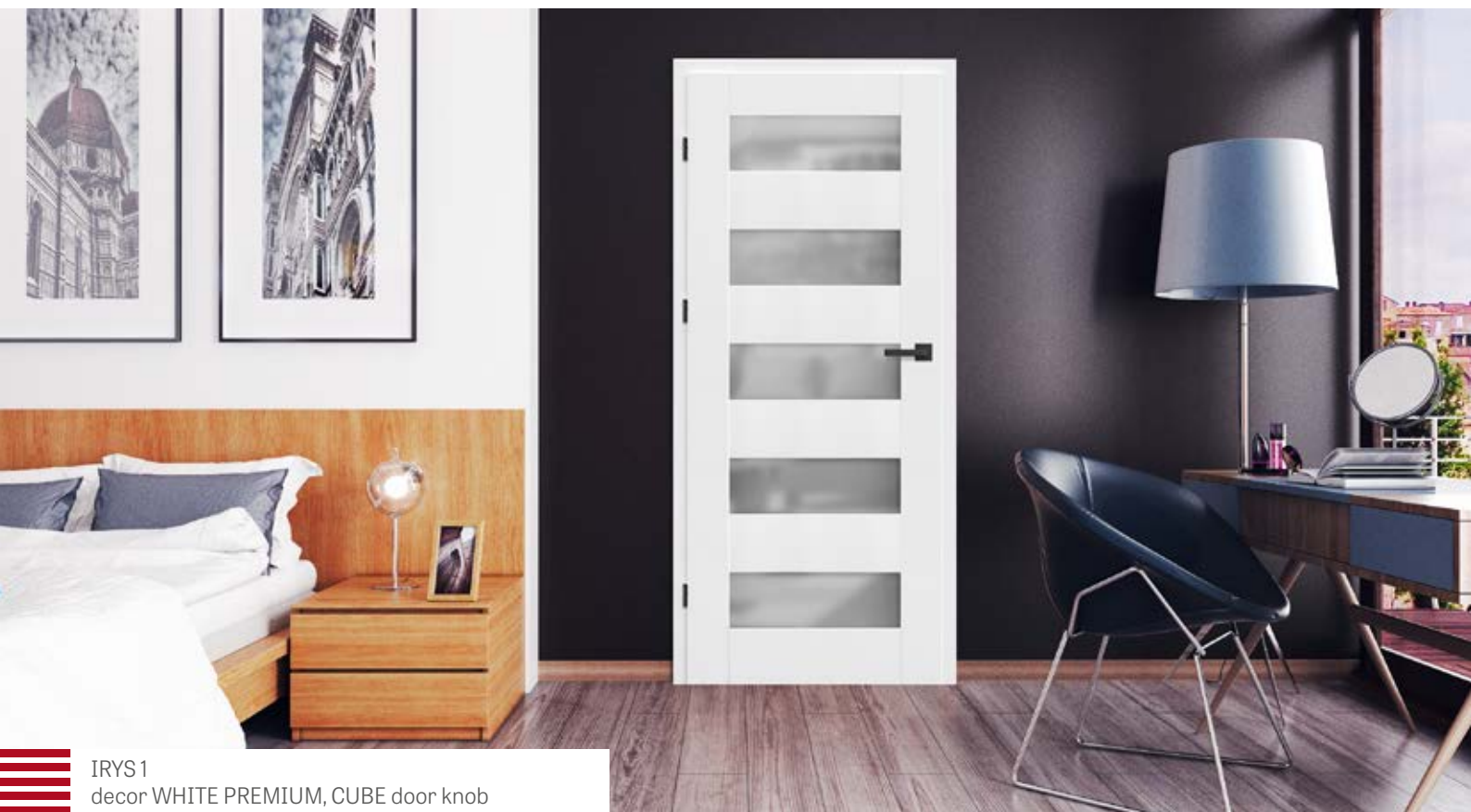

IRYS 1
decor WHITE PREMIUM, CUBE door knob



IRYS 1



IRYS 2



IRYS 3



IRYS 4



IRYS 5



IRYS 6



IRYS 7



IRYS 8



Presented model: IRYS 1 in WHITE PREMIUM decor with CUBE door knob



CONSTRUCTION

- rebated or non-rebated door leaf made in STILE technology
- MDF rails covered in GREKO decors and vertical wooden rails covered with thin HDF in PREMIUM or CPL decors
- HDF boards 4mm thick covered with GREKO, CPL or PREMIUM decors

HARDWARE

- rebated door leaves: three silver pintle hinges regulated horizontally, bolt lock
- non-rebated door leaves: three hidden hinges regulated in three planes, magnetic lock, cylinder lock, economy lock or bathroom lock

GLAZING

- milk or transparent hardened glass fixed in standard or VSG 221 security type of glass, smooth on both sides additionally charged
- possibility to modify glazing for REVERSE (OBVERSE in standard glazing)

AVAILABLE SOLUTIONS (page 119-130)

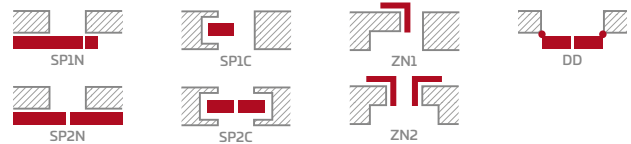

AVAILABLE DOOR WIDTHS

60 70 80 90 100

ADDITIONAL CHARGES

ventilation cut

plastic ventilation sleeves (4 pieces)

metal ventilation grill round and square (4 pieces);
finishing: brushed nickel or patina, white and black

ventilation grill (only for door leaves in widths: 80, 90, 100)

rebated and non-rebated door leaf 100 wide

VSG 221 security type of glass, smooth on both sides
price for one piece of the glass

metal hinge casings for rebated door leaf
colour: brushed nickel, patina, polished chrome, polished brass,
white and black

automatic door seal

GREKO



PREMIUM

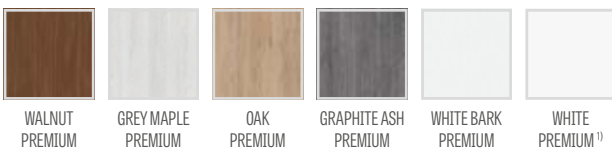

CPL



MDF rail for GREKO foils



Wooden rail for PREMIUM and CPL decors

¹⁾ white foil imitating painting surface

²⁾ available from 1st April 2019



DAGLEZJA



REBATED AND NON-REBATED INTERIOR STILE DOOR LEAFS



DAGLEZJA1
decor GREY OAK GREKO, ERKADO door knob



DAGLEZJA 1



DAGLEZJA 2



DAGLEZJA 3



DAGLEZJA 4



DAGLEZJA 5



DAGLEZJA 6



DAGLEZJA 7



DAGLEZJA 8



Presented model: DAGLEZJA 1 in GREY OAK GREKO decor with ERKADO black matt door knob



GREKO



PREMIUM

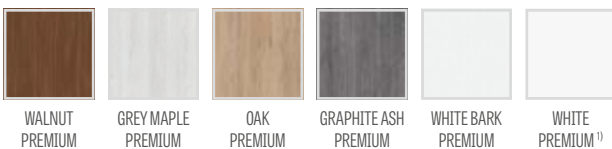

CPL



MDF rail for GREKO foils



Wooden rail for PREMIUM and CPL decors

CONSTRUCTION

- rebated or non-rebated door leaf made in STILE technology
- MDF rails in GREKO decors or vertical wooden rails covered with thin HDF in PREMIUM or CPL decors
- HDF boards 4mm thick covered with GREKO, CPL or PREMIUM decors
- very wide bar

HARDWARE

- rebated door leaves: three silver pintle hinges regulated horizontally, bolt lock
- non-rebated door leaves: three hidden hinges regulated in three planes, magnetic lock, cylinder lock, economy lock or bathroom lock

GLAZING

- milk or transparent hardened glass fixed in standard or VSG 221 security type of glass, smooth on both sides additionally charged
- possibility to modify glazing for REVERSE (OBVERSE in standard glazing)

AVAILABLE SOLUTIONS (page 119-130)

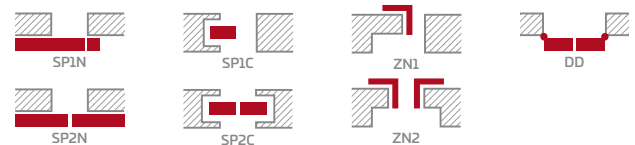

AVAILABLE DOOR WIDTHS

60 70 80 90 100

ADDITIONAL CHARGES

ventilation cut

plastic ventilation sleeves (4 pieces)

metal ventilation grill round and square (4 pieces);
finishing: brushed nickel or patina, white and black

ventilation grill (only for door leaves in widths: 80, 90, 100)

rebated and non-rebated door leaf 100 wide

VSG 221 security type of glass, smooth on both sides
price for one piece of the glass

metal hinge casings for rebated door leaf
colour: brushed nickel, patina, polished chrome, polished brass,
white and black

automatic door seal

¹⁾ white foil imitating painting surface

²⁾ available from 1st April 2019



FREZJA



REBATED AND NON-REBATED INTERIOR STILE DOOR LEAFS



FREZJA 5
decor ELM GREKO, MILANO door knob



FREZJA 1



FREZJA 2



FREZJA 3 ²⁾



FREZJA 4



FREZJA 5



FREZJA 6



FREZJA 7 ³⁾



FREZJA 8

²⁾ FREZJA 3 and 8 – glass 8mm
³⁾ FREZJA 7 – model only with the glass
other side - board covered
with given decor



Presented model: FREZJA 1 in ELM GREKO decor with MILANO door knob



GREKO



PREMIUM

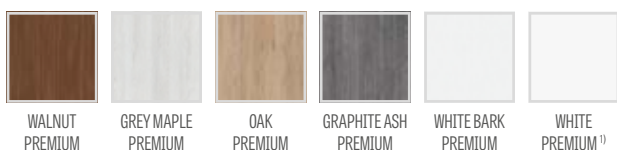

CPL



MDF rail for GREKO foils



Wooden rail for PREMIUM and CPL decors

CONSTRUCTION

- rebated or non-rebated door leaf made in STILE technology
- MDF rails covered in GREKO decors and vertical wooden rails covered with thin HDF in PREMIUM and CPL decors
- HDF boards 16 mm thick (in FREZJA 2 and 6 also 4 mm) covered in GREKO, CPL or PREMIUM, FREZJA 7 available only with mirror.

HARDWARE

- rebated door leaves: three silver pintle hinges regulated horizontally, bolt lock
- non-rebated door leaves: three hidden hinges regulated in three planes, magnetic lock, cylinder lock, economy lock or bathroom lock

GLAZING

- milk or transparent hardened glass fixed in standard or VSG 221 security type of glass, smooth on both sides additionally charged (excluding FREZJA 8)
- possibility to modify glazing for REVERSE (OBVERSE in standard glazing)

AVAILABLE SOLUTIONS³⁾ (page 119-130)

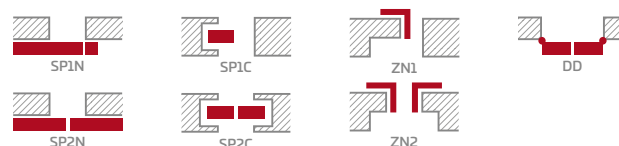

AVAILABLE DOOR WIDTHS



ADDITIONAL CHARGES

ventilation cut

plastic ventilation sleeves (4 pieces) ²⁾

metal hinge casings, round and square ²⁾
(4 pcs.); FINISHING: brushed nickel, patina, white and black

ventilation grill ²⁾ (only for door leaves in widths: 80, 90, 100)

rebated and non-rebated door leaf 100 wide

VSG 221 security type of glass, smooth on both sides

metal hinge casings for rebated door leaf
colour: brushed nickel, patina, polished chrome, polished brass, white and black

automatic door seal
(excluding FREZJA 8)

¹⁾ white foil imitating painting surface

²⁾ not available for FREZJA 8

³⁾ FREZJA 8 is not available in sliding systems

⁴⁾ available from 1st April 2019



DEBECJA



REBATED AND NON-REBATED INTERIOR STILE DOOR LEAFS



DEBECJA 1
decor GRAPHITE ASH PREMIUM, MILANO door knob



DEBECJA 1



DEBECJA 2



DEBECJA 3



DEBECJA 4



DEBECJA 5



DEBECJA 6



DEBECJA 7



Presented model: DEBECJA 1 in GRAPHITE ASH PREMIUM decor with MILANO door knob



GREKO



PREMIUM

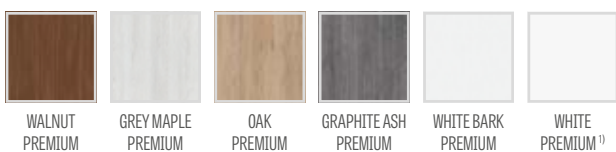

CPL



MDF rail for GREKO foils



Wooden rail for PREMIUM and CPL decors

CONSTRUCTION

- rebated or non-rebated door leaf made in STILE technology
- MDF rails covered in GREKO decors and vertical wooden rails covered with thin HDF in PREMIUM and CPL decors
- HDF boards 4mm thick covered with GREKO, CPL or PREMIUM decors
- very wide bar

HARDWARE

- rebated door leaves: three silver pintle hinges regulated horizontally, bolt lock
- non-rebated door leaves: three hidden hinges regulated in three planes, magnetic lock, cylinder lock, economy lock or bathroom lock

GLAZING

- milk or transparent hardened glass fixed in standard or VSG 221 security type of glass, smooth on both sides additionally charged
- possibility to modify glazing for REVERSE (OBVERSE in standard glazing)

AVAILABLE SOLUTIONS (page 119-130)

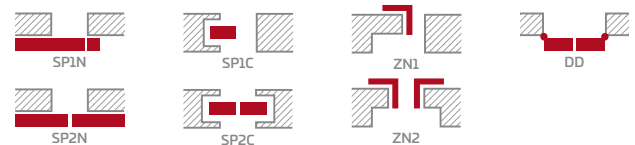

AVAILABLE DOOR WIDTHS



ADDITIONAL CHARGES

ventilation cut

plastic ventilation sleeves (4 pieces)

metal ventilation grill round and square (4 pieces);
finishing: brushed nickel or patina, white and black

ventilation grill (only for door leaves in widths: 80, 90, 100)

rebated and non-rebated door leaf 100 wide

VSG 221 security type of glass, smooth on both sides
price for one piece of the glass

metal hinge casings for rebated door leaf
colour: brushed nickel, patina, polished chrome, polished brass, white and black

automatic door seal

¹⁾ white foil imitating painting surface

²⁾ available from 1st April 2019

NEMEZJA



REBATED AND NON-REBATED INTERIOR STILE DOOR LEAFS



NEMEZJA 7
decor MEDIUM OAK GREKO, FUTURA INOX door knob



NEMEZJA 1



NEMEZJA 4



NEMEZJA 6



NEMEZJA 7



NEMEZJA 8



NEMEZJA 9



NEMEZJA 10



NEMEZJA 11



NEMEZJA 12

Presented model: NEMEZJA 6 in MEDIUM OAK GREKO decor with FUTURA INOX door knob



GREKO



PREMIUM

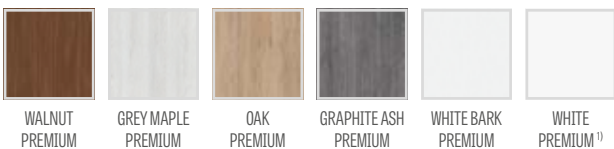

CPL



MDF rail for GREKO foils



Wooden rail for PREMIUM and CPL decors

CONSTRUCTION

- rebated or non-rebated door leaf made in STILE technology
- MDF rails covered in GREKO decors and vertical wooden rails covered with thin HDF in PREMIUM and CPL decors
- HDF boards 16 mm thick, chamfered and covered with selected GREKO, CPL or PREMIUM decors

HARDWARE

- rebated door leaves: three silver pintle hinges regulated horizontally, bolt lock
- non-rebated door leaves: three hidden hinges regulated in three planes, magnetic lock, cylinder lock, economy lock or bathroom lock

GLAZING

- milk or transparent hardened glass fixed in standard or VSG 221 security type of glass, smooth on both sides additionally charged
- possibility to modify glazing for REVERSE (OBVERSE in standard glazing)

AVAILABLE SOLUTIONS (page 119-130)

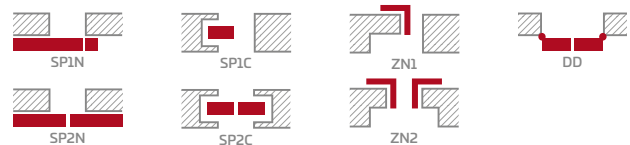

AVAILABLE DOOR WIDTHS

60 70 80 90 100

ADDITIONAL CHARGES

ventilation cut

plastic ventilation sleeves (4 pieces)

metal ventilation grill round and square (4 pieces); finishing: brushed nickel or patina, white and black

ventilation grill (only for door leaves in widths: 80, 90, 100)

rebated and non-rebated door leaf 100 wide

VSG 221 security type of glass, smooth on both sides

metal hinge casings for rebated door leaf
colour: brushed nickel, patina, polished chrome, polished brass, white and black

automatic door seal

¹⁾ white foil imitating painting surface

²⁾ available from 1st April 2019



BERBERYS



REBATED AND NON-REBATED INTERIOR STILE DOOR LEAFS



BERBERYS 1
decor GREY MAPLE PREMIUM, FUTURA INOX door knob



BERBERYS 1



BERBERYS 2



BERBERYS 3



BERBERYS 4



BERBERYS 5



BERBERYS 6



BERBERYS 7



BERBERYS 8



Presented model: BERBERYS 1 in GREY MAPLE PREMIUM decor with FUTURA INOX door knob



GREKO



PREMIUM

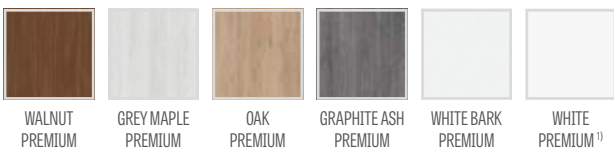

CPL



MDF rail for GREKO foils



Wooden rail for PREMIUM and CPL decors

CONSTRUCTION

- rebated or non-rebated door leaf made in STILE technology
- MDF rails covered in GREKO decors and vertical wooden rails covered with thin HDF in PREMIUM and CPL decors
- HDF boards 4mm thick covered with GREKO, CPL or PREMIUM decors
- brushed aluminium profiles

HARDWARE

- rebated door leaves: three silver pintle hinges regulated horizontally, bolt lock
- non-rebated door leaves: three hidden hinges regulated in three planes, magnetic lock, cylinder lock, economy lock or bathroom lock

GLAZING

- milk or transparent hardened glass fixed in standard or VSG 221 security type of glass, smooth on both sides additionally charged
- possibility to modify glazing for REVERSE (OBVERSE in standard glazing)

AVAILABLE SOLUTIONS (page 119-130)

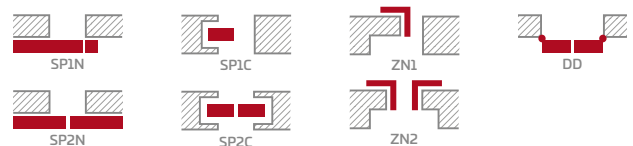

AVAILABLE DOOR WIDTHS



ADDITIONAL CHARGES

ventilation cut

plastic ventilation sleeves (4 pieces)

metal ventilation grill round and square (4 pieces);
finishing: brushed nickel or patina, white and black

ventilation grill (only for door leaves in widths: 80, 90, 100)

rebated and non-rebated door leaf 100 wide

VSG 221 security type of glass, smooth on both sides
price for one piece of the glass

metal hinge casings for rebated door leaf
colour: brushed nickel, patina, polished chrome, polished brass,
white and black

automatic door seal

¹⁾ white foil imitating painting surface

²⁾ available from 1st April 2019



FLOKS



REBATED AND NON-REBATED INTERIOR STILE DOOR LEAFS



FLOKS 8
decor OAK ST CPL, CUBE door knob



FLOKS 1



FLOKS 2



FLOKS 3



FLOKS 4



FLOKS 5



FLOKS 6



FLOKS 7

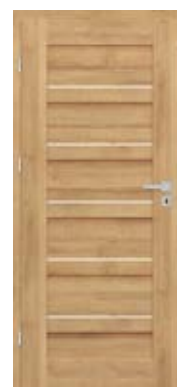

FLOKS 8



Presented model: FLOKS 1 in OAK ST CPL decor with CUBE door knob



CONSTRUCTION

- rebated or non-rebated door leaf made in STILE technology
- MDF rails covered in GREKO decors and vertical wooden rails covered with thin HDF in PREMIUM and CPL decors
- HDF boards 4mm thick covered with GREKO, CPL or PREMIUM decors
- brushed aluminium profiles

HARDWARE

- rebated door leaves: three silver pintle hinges regulated horizontally, bolt lock
- non-rebated door leaves: three hidden hinges regulated in three planes, magnetic lock, cylinder lock, economy lock or bathroom lock

GLAZING

- milk or transparent hardened glass fixed in standard or VSG 221 security type of glass, smooth on both sides additionally charged
- possibility to modify glazing for REVERSE (OBVERSE in standard glazing)

AVAILABLE SOLUTIONS (page 119-130)

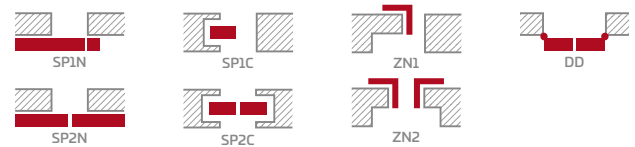

AVAILABLE DOOR WIDTHS

60 70 80 90 100

ADDITIONAL CHARGES

ventilation cut

plastic ventilation sleeves (4 pieces)

metal ventilation grill round and square (4 pieces);
finishing: brushed nickel or patina, white and black

ventilation grill (only for door leaves in widths: 80, 90, 100)

rebated and non-rebated door leaf 100 wide

VSG 221 security type of glass, smooth on both sides
price for one piece of the glass

metal hinge casings for rebated door leaf
colour: brushed nickel, patina, polished chrome, polished brass,
white and black

automatic door seal

GREKO



PREMIUM

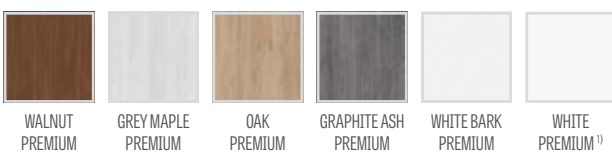

CPL



MDF rail for GREKO foils



Wooden rail for PREMIUM
and CPL decors

¹⁾ white foil imitating painting surface

²⁾ available from 1st April 2019



KROKUS



REBATED AND NON-REBATED INTERIOR STILE DOOR LEAFS



KROKUS 1
decor WALNUT GREKO, DECO door knob



KROKUS 1



KROKUS 2



KROKUS 3



KROKUS 4



KROKUS 5



KROKUS 6



Presented model: KROKUS 1 in WALNUT GREKO decor with DECO door knob



CONSTRUCTION

- rebated or non-rebated door leaf made in STILE technology
- MDF rails covered in GREKO decors and vertical wooden rails covered with thin HDF in PREMIUM and CPL decors
- HDF boards 4mm thick covered with GREKO, CPL or PREMIUM decors
- brushed aluminium profiles

HARDWARE

- rebated door leaves: three silver pintle hinges regulated horizontally, bolt lock
- non-rebated door leaves: three hidden hinges regulated in three planes, magnetic lock, cylinder lock, economy lock or bathroom lock

GLAZING

- milk or transparent hardened glass fixed in standard or VSG 221 security type of glass, smooth on both sides additionally charged
- possibility to modify glazing for REVERSE (OBVERSE in standard glazing)

AVAILABLE SOLUTIONS (page 119-130)

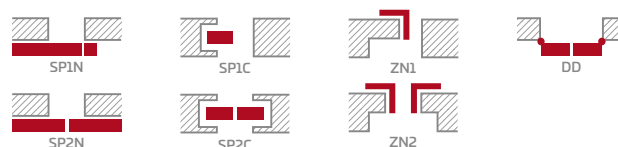

AVAILABLE DOOR WIDTHS



ADDITIONAL CHARGES

ventilation cut

plastic ventilation sleeves (4 pieces)

metal ventilation grill round and square (4 pieces);
finishing: brushed nickel or patina, white and black

ventilation grill (only for door leaves in widths: 80, 90, 100)

rebated and non-rebated door leaf 100 wide

VSG 221 security type of glass, smooth on both sides
price for one piece of the glass

metal hinge casings for rebated door leaf
colour: brushed nickel, patina, polished chrome, polished brass,
white and black

automatic door seal

GREKO



PREMIUM

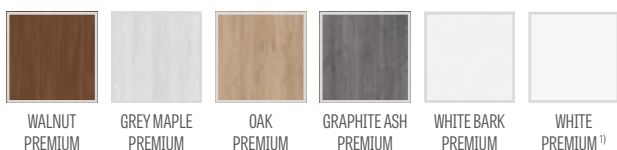

CPL



MDF rail for GREKO foils



Wooden rail for PREMIUM and CPL decors

¹⁾ white foil imitating painting surface

²⁾ available from 1st April 2019



KAMELIA



REBATED AND NON-REBATED INTERIOR STILE DOOR LEAFS



KAMELIA 1
decor GRAPHITE ASH PREMIUM, CUBE door knob



KAMELIA 1



KAMELIA 2



KAMELIA 3



KAMELIA 4



KAMELIA 5



KAMELIA 6



KAMELIA 7



KAMELIA 8



Model KAMELIA 1 in GRAPHITE ASH PREMIUM decor with CUBE door knob



CONSTRUCTION

- rebated or non-rebated door leaf made in STILE technology
- MDF rails covered in GREKO decors and vertical wooden rails covered with thin HDF in PREMIUM and CPL decors
- HDF boards 4mm thick covered with GREKO, CPL or PREMIUM decors

HARDWARE

- rebated door leaves: three silver pintle hinges regulated horizontally, bolt lock
- non-rebated door leaves: three hidden hinges regulated in three planes, magnetic lock, cylinder lock, economy lock or bathroom lock

GLAZING

- milk or transparent hardened glass fixed in standard or VSG 221 security type of glass, smooth on both sides additionally charged
- possibility to modify glazing for REVERSE (OBVERSE in standard glazing)

AVAILABLE SOLUTIONS (page 119-130)

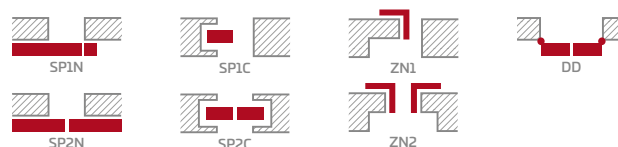

AVAILABLE DOOR WIDTHS

60 70 80 90 100

ADDITIONAL CHARGES

ventilation cut

plastic ventilation sleeves (4 pieces)

metal ventilation grill round and square (4 pieces);
finishing: brushed nickel or patina, white and black

ventilation grill (only for door leaves in widths: 80, 90, 100)

rebated and non-rebated door leaf 100 wide

VSG 221 security type of glass, smooth on both sides
price for one piece of the glass

metal hinge casings for rebated door leaf
colour: brushed nickel, patina, polished chrome, polished brass,
white and black

automatic door seal

GREKO



PREMIUM



CPL



MDF rail for GREKO foils



Wooden rail for PREMIUM and CPL decors

¹⁾ white foil imitating painting surface

²⁾ vertical rails in WHITE GREKO decor, vertical elements and boards in WALNUT GREKO decor

³⁾ available from 1st April 2019



PETUNIA



REBATED AND NON-REBATED INTERIOR STILE DOOR LEAFS



PETUNIA 1
decor OAK PREMIUM, FUTURA INOX door knob



PETUNIA 1



PETUNIA 2



PETUNIA 3



PETUNIA 4



PETUNIA 5



PETUNIA 6



PETUNIA 7



PETUNIA 8



Presented model: PETUNIA 1 in OAK PREMIUM decor with FUTURA INOX door knob



GREKO



PREMIUM

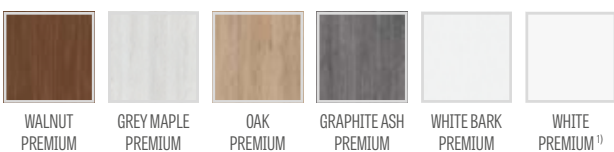

CPL



MDF rail for GREKO foils



Wooden rail for PREMIUM and CPL decors

CONSTRUCTION

- rebated or non-rebated door leaf made in STILE technology
- MDF rails covered in GREKO decors and vertical wooden rails covered with thin HDF in PREMIUM and CPL decors
- HDF boards 4mm thick covered with GREKO, CPL or PREMIUM decors

HARDWARE

- rebated door leaves: three silver pintle hinges regulated horizontally, bolt lock
- non-rebated door leaves: three hidden hinges regulated in three planes, magnetic lock, cylinder lock, economy lock or bathroom lock

GLAZING

- milk or transparent hardened glass fixed in standard or VSG 221 security type of glass, smooth on both sides additionally charged
- possibility to modify glazing for REVERSE (OBVERSE in standard glazing)

AVAILABLE SOLUTIONS (page 119-130)

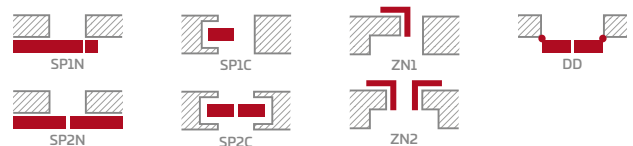

AVAILABLE DOOR WIDTHS



ADDITIONAL CHARGES

ventilation cut

plastic ventilation sleeves (4 pieces)

metal ventilation grill round and square (4 pieces); finishing: brushed nickel or patina, white and black

ventilation grill (only for door leaves in widths: 80, 90, 100)

rebated and non-rebated door leaf 100 wide

VSG 221 security type of glass, smooth on both sides price for one piece of the glass

metal hinge casings for rebated door leaf colour: brushed nickel, patina, polished chrome, polished brass, white and black

automatic door seal

¹⁾ white foil imitating painting surface

²⁾ available from 1st April 2019



AZALIA



REBATED AND NON-REBATED INTERIOR STILE DOOR LEAFS



AZALIA 1
decor OAK ST CPL, CUBE door knob



AZALIA 1



AZALIA 2



AZALIA 3



AZALIA 4



AZALIA 5



AZALIA 6



AZALIA 7



AZALIA 8



Presented model: AZALIA 1 in OAK ST CPL decor with CUBE door knob



CONSTRUCTION

- rebated or non-rebated door leaf made in STILE technology
- MDF rails covered in GREKO decors and vertical wooden rails covered with thin HDF in PREMIUM and CPL decors
- HDF boards 4mm thick covered with GREKO, CPL or PREMIUM decors

HARDWARE

- rebated door leaves: three silver pintle hinges regulated horizontally, bolt lock
- non-rebated door leaves: three hidden hinges regulated in three planes, magnetic lock, cylinder lock, economy lock or bathroom lock

GLAZING

- milk or transparent hardened glass fixed in standard or VSG 221 security type of glass, smooth on both sides additionally charged
- possibility to modify glazing for REVERSE (OBVERSE in standard glazing)

AVAILABLE SOLUTIONS (page 119-130)

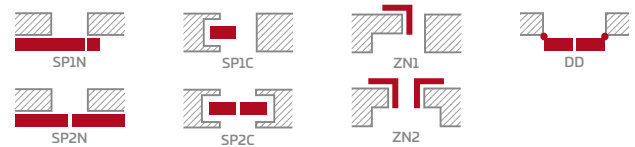

AVAILABLE DOOR WIDTHS

60 70 80 90 100

ADDITIONAL CHARGES

ventilation cut

plastic ventilation sleeves (4 pieces)

metal ventilation grill round and square (4 pieces);
finishing: brushed nickel or patina, white and black

ventilation grill (only for door leaves in widths: 80, 90, 100)

rebated and non-rebated door leaf 100 wide

VSG 221 security type of glass, smooth on both sides
price for one piece of the glass

metal hinge casings for rebated door leaf
colour: brushed nickel, patina, polished chrome, polished brass,
white and black

automatic door seal

GREKO



PREMIUM

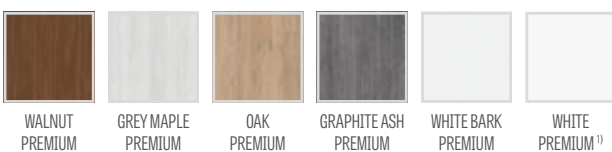

CPL



MDF rail for GREKO foils



Wooden rail for PREMIUM and CPL decors

¹⁾ white foil imitating painting surface

²⁾ available from 1st April 2019

HIACYNT

REBATED AND NON-REBATED INTERIOR STILE DOOR LEAFS



HIACYNT 6
decor WALNUT GREKO, FUTURA INOX door knob



HIACYNT 1



HIACYNT 2



HIACYNT 3



HIACYNT 4



HIACYNT 5



HIACYNT 6



HIACYNT 7



HIACYNT 8

Presented model: HIACYNT 1 in MEDIUM OAK GREKO decor with FUTURA INOX door knob



GREKO



PREMIUM



CPL



MDF rail for GREKO foils



Wooden rail for PREMIUM and CPL decors

CONSTRUCTION

- rebated or non-rebated door leaf made in STILE technology
- MDF rails covered in GREKO decors and vertical wooden rails covered with thin HDF in PREMIUM and CPL decors
- HDF boards 22mm thick covered with GREKO, CPL or PREMIUM decors

HARDWARE

- rebated door leaves: three silver pintle hinges regulated horizontally, bolt lock
- non-rebated door leaves: three hidden hinges regulated in three planes, magnetic lock, cylinder lock, economy lock or bathroom lock

GLAZING

- milk or transparent hardened glass fixed in standard or VSG 221 security type of glass, smooth on both sides additionally charged
- possibility to modify glazing for REVERSE (OBVERSE in standard glazing)

AVAILABLE SOLUTIONS (page 119-130)

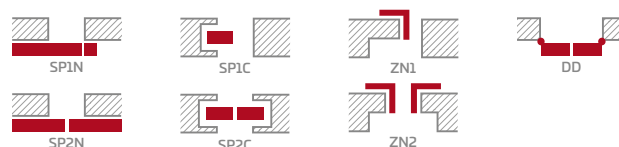

AVAILABLE DOOR WIDTHS



ADDITIONAL CHARGES

ventilation cut

plastic ventilation sleeves (4 pieces)

metal ventilation grill round and square (4 pieces);
finishing: brushed nickel or patina, white and black

ventilation grill (only for door leaves in widths: 80, 90, 100)

rebated and non-rebated door leaf 100 wide

VSG 221 security type of glass, smooth on both sides

metal hinge casings for rebated door leaf
colour: brushed nickel, patina, polished chrome, polished brass,
white and black

automatic door seal

¹⁾ white foil imitating painting surface

²⁾ available from 1st April 2019



FRAGI



REBATED AND NON-REBATED INTERIOR STILE DOOR LEAFS



FRAGI 1
decor WALNUT GREKO, DECO door knob



FRAGI 1



FRAGI 2



FRAGI 3



FRAGI 4
DECORMAT



FRAGI 5
TRANSPARENT



FRAGI 7
DECORMAT GRAPHITE



FRAGI 9



FRAGI 10



Presented model: FRAGI 4 in WALNUT GREKO decor with DECO door knob



CONSTRUCTION

- rebated door leaf made in STILE technology
- MDF rails covered in GREKO decors and vertical wooden rails covered with thin HDF in PREMIUM and CPL decors

HARDWARE

- rebated door leaves: three silver pintle hinges regulated horizontally, bolt lock
- bolt lock for regular key, cylinder, economy lock or bathroom lock

GLAZING

- hardened glass 8 mm thick
- possibility to modify glazing for REVERSE (OBVERSE in standard glazing)

AVAILABLE SOLUTIONS (page 128-130)



AVAILABLE DOOR WIDTHS



ADDITIONAL CHARGES

ventilation cut

metal hinge casings for rebated door leaf
colour: brushed nickel, patina, polished chrome, polished brass, white and black

GREKO



PREMIUM

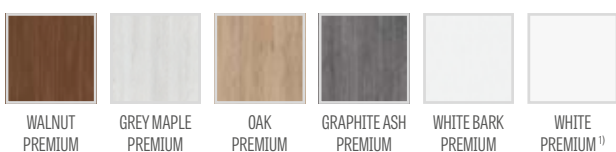

CPL



MDF rail for GREKO foils



Wooden rail for PREMIUM and CPL decors

GLAZING IN STANDARD - OBVERSE

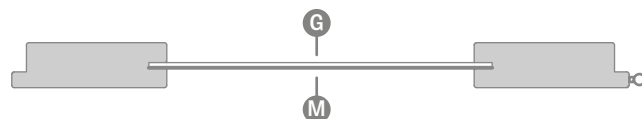

GLAZING ON DEMAND - REVERSE

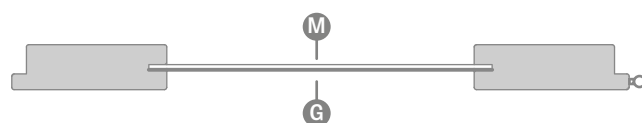

G smooth side; **M** matt decorated side

¹⁾ white foil imitating painting surface

²⁾ available from 1st April 2019



GRAF GLASS DOORS

GLASS INTERIOR DOOR LEAFS



GRAF 5



GRAF 6



GRAF 7



GRAF 8 DECORMAT



GRAF 9 PRZECROCYSTE



GRAF 11 DECORMAT GRAFIT



GRAF 12



GRAF 16



GRAF 17



GRAF 18



GRAF 20



GRAF 22



Presented model: GRAF 1 in WHITE GREKO

CONSTRUCTION

- hardened glass 8 mm thick
- possibility to modify glazing for REVERSE (OBVERSE in standard)
- milk glass with decors painted in black or in white

FIXED AND ADJUSTABLE FRAME

- prices of fixed and adjustable frames are the same as for rebated frames
- no possibility to apply electric strike
- **GRAF REBATED FRAMES COME IN ALL AVAILABLE DECORS AS FOR REGULAR REBATED FRAMES AND WHITE UV PAINTED FRAME**

Attention:

Presented graphics of MODEL GRAF concerns only the Door width 80 cm. The remaining widths in GRAF 1, 5, 7, 12, 16, 18 will show little differences in the proportion of graphics. Detailed information can be accessed online at www.erkado.pl

AVAILABLE DOOR WIDTHS

60	70	80	90 (additionally charged)
----	----	----	---------------------------

ADDITIONAL CHARGES

door leaf 90 cm wide

ventilation cut

hardware

HARDWARE METAL-BUD stainless steel

Metal-Bud

Available shapes: oval or rectangular



2A OVAL



3A OVAL



1A OVAL



4AZ OVAL EXTERIOR
4AW OVAL INTERIOR



HINGE OVAL



2B RECTANGULAR



3B RECTANGULAR



1B RECTANGULAR



4BZ RECTANGULAR EXTERIOR
4BW RECTANGULAR INTERIOR



HINGE RECTANGULAR



UNO PREMIUM

NEW



PAINTED, REBATED, NON-REBATED AND REVERSE DOOR LEAFS



UNO PREMIUM
CUBE door knob

non-rebated doors, cover 8 cm, frame connection 90°, frame side view



rebated doors, cover 8 cm, frame connection 45°, frame side view



rebated doors, cover 6 cm, frame connection 45°, hinge side view





Presented model: UNO PREMIUM with CUBE door knob



CONSTRUCTION

- rebated, non-rebated or reverse door leaf
- inner wooden rail (bottom, upper and sides - mdf) covered with two HDF boards
- honeycomb core filling or full plate board (add. charged)

FINISHING

- door leaves and door frames painted with water lacquer hardened with UV technology, resulting in high resistance to extensive conditions
- door leaf edge made in standard technology

HARDWARE

- rebated door leaf: three pintle hinges, bolt lock
- non-rebated door leaf: three hidden hinges, lock for key, cylinder, economy or bathroom lock
- reverse door leaf: two hidden hinges, lock for key, cylinder, economy or bathroom lock

PAINTED



WHITE TITANIUM UV

AVAILABLE SOLUTIONS (page 119-130)



AVAILABLE DOOR WIDTHS

60 70 80 90 100

ADDITIONAL CHARGES

reverse door leaf **NEW**

filling with solid board

ventilation cut

rebated and non-rebated door leaf 100 wide

metal hinge casings for rebated door leaf
colour: brushed nickel, patina, polished chrome, polished brass, white and black

automatic door seal





TURAN

NEW



PAINTED, REBATED, NON-REBATED AND REVERSE DOOR LEAFS



TURAN 4
CUBE door knob



TURAN 1



TURAN 2



TURAN 3



TURAN 4



TURAN 5



Presented model: TURAN 5 with CUBE door knob



CONSTRUCTION

- rebated or non-rebated door leaf made in STILE technology
- vertical wooden rails covered with thin HDF boards covered in decor and painted with resistant UV lacquer
- HDF boards 16 mm thick, milled and painted resistant UV lacquer

FINISHING

- door leaves and door frames painted with water lacquer hardened with UV technology, resulting in high resistance to extensive conditions

HARDWARE

- rebated door leaves: three silver pintle hinges regulated horizontally, bolt lock
- non-rebated door leaves: three hidden hinges regulated in three planes, magnetic lock, cylinder lock, economy lock or bathroom lock

GLAZING

- TURAN 1 hardened glass 8 mm thick or VSG441 safety milk glass, smooth on both sides

MILLING

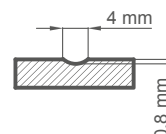

PAINTED



WHITE TITANIUM UV

AVAILABLE SOLUTIONS (page 119-130)



AVAILABLE DOOR WIDTHS

60 70 80 90 100

ADDITIONAL CHARGES

ventilation cut

rebated and non-rebated door leaf 100 wide

metal hinge casings for rebated door leaf
colour: brushed nickel, patina, polished chrome, polished brass, white and black

automatic door seal

VSG 441 safety milk glass, smooth on both sides

MILDA

NEW



PAINTED, REBATED, NON-REBATED AND REVERSE DOOR LEAFS



MILDA 3
CUBE PREMIUM black door knob



MILDA 1



MILDA 2



MILDA 3



MILDA 4



MILDA 5

Presented model: MILDA 2 with CUBE PREMIUM black door knob



CONSTRUCTION

- rebated, non-rebated or reverse door leaf
- inner wooden rail (bottom, upper and sides - mdf) covered with two HDF boards
- honeycomb core filling or full plate board (add. charged)

FINISHING

- door leaves and door frames painted with water lacquer hardened with UV technology, resulting in high resistance to extensive conditions
- door leaf edge made in standard or non-rebated technology

HARDWARE

- rebated door leaf: three pintle hinges, bolt lock
- non-rebated door leaf: three hidden hinges, lock for key, cylinder, economy or bathroom lock
- reverse door leaf: two hidden hinges, lock for key, cylinder, economy or bathroom lock

MILLING

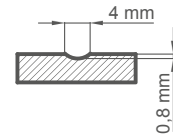

PAINTED



WHITE TITANIUM UV

AVAILABLE SOLUTIONS (page 119-130)



AVAILABLE DOOR WIDTHS

60 70 80 90 100

ADDITIONAL CHARGES

reverse door leaf **NEW**

filling with solid board

ventilation cut

rebated and non-rebated door leaf 100 wide

metal hinge casings for rebated door leaf
 colour: brushed nickel, patina, polished chrome, polished brass, white and black

automatic door seal



BALDUR

NEW



PAINTED, REBATED, NON-REBATED AND REVERSE DOOR LEAFS



BALDUR1
CUBE PREMIUM door knob



BALDUR1



BALDUR2



BALDUR3



BALDUR4



BALDUR5



BALDUR6



Presented model: BALDUR 5 with CUBE PREMIUM door knob



PAINTED



WHITE TITANIUM UV

AVAILABLE SOLUTIONS¹⁾ (page 119-130)



AVAILABLE DOOR WIDTHS

60 70 80 90 100

CONSTRUCTION

- rebated, non-rebated or reverse door leaf
- inner wooden rail (bottom, upper and sides - mdf) covered with two HDF boards
- honeycomb core filling or full plate board (add. charged)

FINISHING

- door leaves and door frames painted with water lacquer hardened with UV technology, resulting in high resistance to extensive conditions
- door leaf edge made in standard or non-rebated technology

HARDWARE

- rebated door leaf: three pintle hinges, bolt lock
- non-rebated door leaf: three hidden hinges, lock for key, cylinder, economy or bathroom lock
- reverse door leaf: two hidden hinges, lock for key, cylinder, economy or bathroom lock

GLAZING

- Baldur 1, 3, 5 hardened milk glass 8 mm thick

MILLING

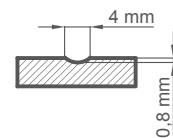

ADDITIONAL CHARGES

reverse door leaf NEW

filling with solid board

ventilation cut

rebated and non-rebated door leaf 100 wide

metal hinge casings for rebated door leaf in brushed nickel, patina, chrome gloss, brass gloss, white and black); price for one hinge

automatic door seal (excluding BALDUR 1, 3, 5)

Ventilation cut



BALDUR 1



BALDUR 3

¹⁾ BALDUR 1, 3, 5 are not available for sliding systems

ANUBIS

NEW



PAINTED, REBATED, NON-REBATED AND REVERSE DOOR LEAFS



ANUBIS 4
CUBE door knob



ANUBIS 1



ANUBIS 2



ANUBIS 3



ANUBIS 4



ANUBIS 5



Presented model: ANUBIS 3 with CUBE door knob



CONSTRUCTION

- rebated, non-rebated or reverse door leaf
- inner wooden rail (bottom, upper and sides - mdf) covered with two HDF boards
- honeycomb core filling or full plate board (add. charged)

FINISHING

- door leaves and door frames painted with water lacquer hardened with UV technology, resulting in high resistance to extensive conditions
- door leaf edge made in standard or non-rebated technology

HARDWARE

- rebated door leaf: three pintle hinges, bolt lock
- non-rebated door leaf: three hidden hinges, lock for key, cylinder, economy or bathroom lock
- reverse door leaf: two hidden hinges, lock for key, cylinder, economy or bathroom lock

MILLING

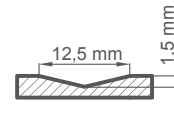

PAINTED



WHITE TITANIUM UV

AVAILABLE SOLUTIONS (page 119-130)



AVAILABLE DOOR WIDTHS

60 70 80 90 100

ADDITIONAL CHARGES

reverse door leaf **NEW**

filling with solid board

ventilation cut

rebated and non-rebated door leaf 100 wide

metal hinge casings for rebated door leaf
colour: brushed nickel, patina, polished chrome, polished brass, white and black

automatic door seal



SYLENA

NEW



PAINTED, REBATED, NON-REBATED AND REVERSE DOOR LEAFS



SYLENA 2
CUBE door knob



SYLENA 1



SYLENA 2



SYLENA 3



SYLENA 4



SYLENA 5



SYLENA 6



SYLENA 7



SYLENA 8

Presented model: SYLENA 7 with CUBE door knob



CONSTRUCTION

- rebated, non-rebated or reverse door leaf
- inner wooden rail (bottom, upper and sides - mdf) covered with two HDF boards
- honeycomb core filling or full plate board (add. charged)

FINISHING

- door leaves and door frames painted with water lacquer hardened with UV technology, resulting in high resistance to extensive conditions
- door leaf edge made in standard or non-rebated technology

HARDWARE

- rebated door leaf: three pintle hinges, bolt lock
- non-rebated door leaf: three hidden hinges, lock for key, cylinder, economy or bathroom lock
- reverse door leaf: two hidden hinges, lock for key, cylinder, economy or bathroom lock

MILLING

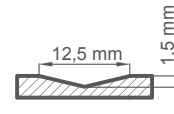

PAINTED



WHITE TITANIUM UV

AVAILABLE SOLUTIONS (page 119-130)



AVAILABLE DOOR WIDTHS

60 70 80 90 100

ADDITIONAL CHARGES

reverse door leaf **NEW**

filling with solid board

ventilation cut

rebated and non-rebated door leaf 100 wide

metal hinge casings for rebated door leaf
colour: brushed nickel, patina, polished chrome, polished brass, white and black

automatic door seal

UNO PREMIUM



INTERIOR REBATED, NON-REBATED AND REVERSE DOOR LEAFS



UNO PREMIUM
decor OAK PREMIUM, LUNA PREMIUM black matt door knob

Presented model: UNO PREMIUM in WALNUT PREMIUM decor with MILANO door knob



Presented model: UNO PREMIUM in OAK PREMIUM decor with CUBE door knob



Presented model: UNO PREMIUM in DIAGONAL LARCH with CUBE PREMIUM door knob



CONSTRUCTION

- rebated, non-rebated or reverse door leaf
- inner wooden rail (bottom, upper and sides - mdf) covered with two HDF boards
- honeycomb core filling or full plate board (add. charged)

FINISHING

- HDF board covered with premium decor
- door leaf edge made in rebated, non-rebated and standard technology
- edge banding compatible with door leaf colours; optionally rebate can be smooth black in WHITE PREMIUM decor and diagonal black in DIAGONAL ASH PREMIUM decor

HARDWARE

- rebated door leaf: three pintle hinges, bolt lock
- non-rebated door leaf: three hidden hinges, lock for key, cylinder, economy or bathroom lock
- reverse door leaf: two hidden hinges, lock for key, cylinder, economy or bathroom lock

AVAILABLE SOLUTIONS (page 119-130)

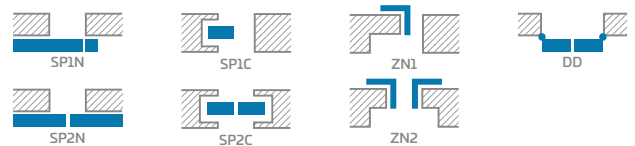

ADDITIONAL CHARGES

reverse door leaf NEW

filling with solid board

enforcement for self-lock

door closer

additional bottom construction bar (offers possibility to individual trim of door leaf up to 8 cm)

metal ventilation grill round and square (4 pieces); finishing: brushed nickel or patina, white and black

plastic ventilation sleeves (4 pieces)

ventilation cut lub ventilation grill

rebated and non-rebated door leaf 100 wide

automatic door seal

metal hinge casings for rebated door leaf
colour: brushed nickel, patina, polished chrome, polished brass, white and black

bull eye stainless steel: polished chrome or brushed satin; milk decormat glass, transparent glass,
dimensions: diameter inside: 235 mm, outside: 350 mm

PREMIUM

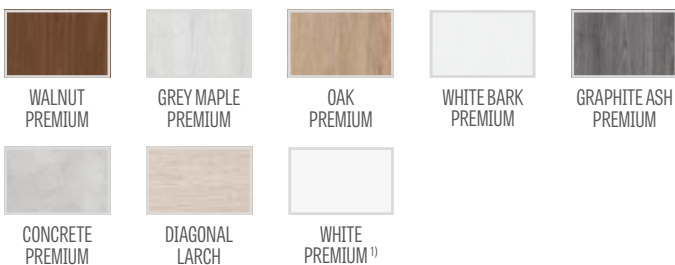

AVAILABLE DOOR WIDTHS

60 70 80 90 100

TYPES OF EDGE FINISHING



¹⁾ white foil imitating painting surface

UNO PREMIUM



INTERIOR REBATED, NON-REBATED AND REVERSE DOOR LEAFS



UNO PREMIUM
decor GRAPHITE ASH PREMIUM, CUBE PREMIUM door knob

Presented model: UNO PREMIUM in GREY MAPLE PREMIUM decor with CUBE door knob



Presented model: UNO PREMIUM in GRAPHITE ASH PREMIUM decor with CUBE PREMIUM door knob





PREMIUM  



UNO PREMIUM
decor CONCRETE PREMIUM, door knob CUBE



Presented model: UNO PREMIUM in WHITE BARK PREMIUM decor with LUNA PREMIUM door knob



Presented model: UNO PREMIUM in DIAGONAL LARCH decor with LUNA PREMIUM door knob





UNO LUX



INTERIOR REBATED, NON-REBATED AND REVERSE DOOR LEAFS



UNO LUX
decor WALNUT GREKO, TUPAI 2275 Q door knob



UNO LUX 1



UNO LUX 3



UNO LUX 4



UNO LUX 7



UNO LUX 8



UNO LUX 9

Presented model: UNO LUX 4 in VENGE ST CPL decor with TUPAI 2275 Q door knob



CONSTRUCTION

- rebated, non-rebated or reverse door leaf
- MDF rail covered with HDF boards in GREKO and FINISH decors
- inner wooden rail (bottom, upper and sides - mdf) covered with two HDF boards in CPL and PREMIUM decors
- honeycomb core filling or full plate board (add. charged)

FINISHING

- HDF board covered with foil
- door leaf made in SOFT or STANDARD technology
- aluminium profiles 8 mm, in line with door leaf surface on both sides of door leaf.

HARDWARE

- rebated door leaf: two or three (GREKO, PREMIUM) pintle hinges, bolt lock
- non-rebated door leaf: three hidden hinges, lock for key, cylinder, economy or bathroom lock
- reverse door leaf: two hidden hinges, lock for key, cylinder, economy or bathroom lock

AVAILABLE DOOR WIDTHS

60 70 80 90 100

ADDITIONAL CHARGES

reverse door leaf **NEW**

filling with solid board (the third hinge is applied and included in the price of a door leaf)

enforcement for self-lock

door closer

additional bottom construction bar (offers possibility to individual trim of door leaf up to 8 cm)

plastic ventilation, metal ventilation round or square (4 pcs.) FINISHING: brushed nickel, patina, white and black

ventilation cut lub ventilation grill (the cut is not possible in models: UNO LUX: 1, 3, 4)

rebated and non-rebated door leaf 100 wide (the third hinge is applied and included in the price of a door leaf)

additional hinge to rebated door leaf (does not concern full plate board, GREKO decors and door leaf 100 cm)

automatic door seal

metal hinge casings for rebated door leaf
colour: brushed nickel, patina, polished chrome, polished brass, white and black

FINISH



WALNUT FINISH

BRIGHT ACACIA FINISH

ACACIA FINISH

GREKO

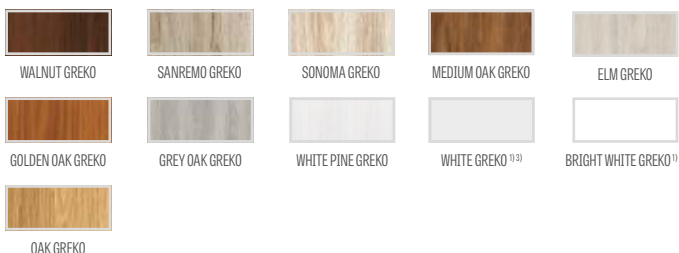

WALNUT GREKO

SANREMO GREKO

SONOMA GREKO

MEDIUM OAK GREKO

ELM GREKO

GOLDEN OAK GREKO

GREY OAK GREKO

WHITE PINE GREKO

WHITE GREKO ¹⁾²⁾

BRIGHT WHITE GREKO ¹⁾²⁾

OAK GREKO

CPL



OAK ST CPL

GREY OAK ST CPL

VENGE ST CPL

GREY PINE ST CPL ⁴⁾

PREMIUM

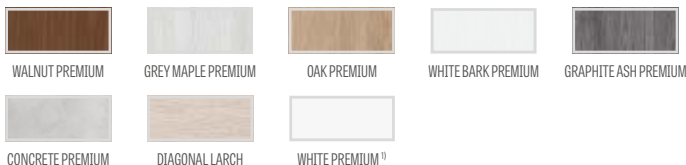

WALNUT PREMIUM

GREY MAPLE PREMIUM

OAK PREMIUM

WHITE BARK PREMIUM

GRAPHITE ASH PREMIUM

CONCRETE PREMIUM

DIAGONAL LARCH

WHITE PREMIUM ¹⁾

AVAILABLE SOLUTIONS (page 119-130)

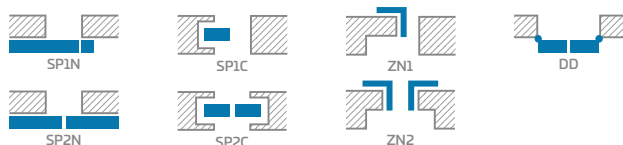

TYPES OF EDGE FINISHING



¹⁾ white foil imitating painting surface, ²⁾ in SOFT technology the foil is connected on the rebate, ³⁾ only STANDARD, ⁴⁾ available from 1st April 2019

BALDUR

NEW



INTERIOR REBATED, NON-REBATED AND REVERSE DOOR LEAFS

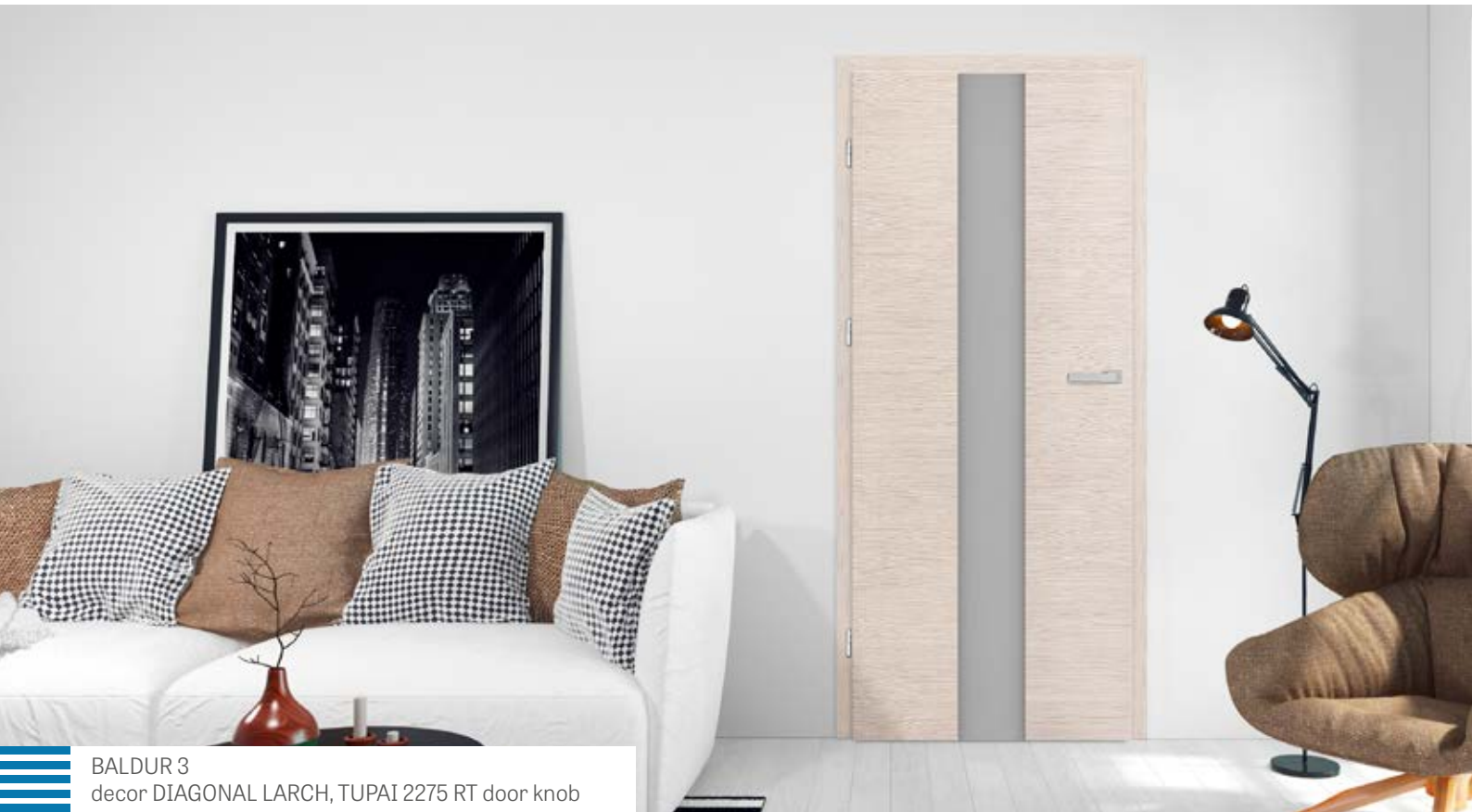

BALDUR 3
decor DIAGONAL LARCH, TUPAI 2275 RT door knob



BALDUR 1



BALDUR 3

Presented model: BALDUR 1 in DIAGONAL LARCH decor with TUPAI 2275 RT brushed chrome door knob



CONSTRUCTION

- rebated, non-rebated or reverse door leaf
- inner wooden rail (bottom, upper and sides - mdf) covered with two HDF boards
- honeycomb core filling or full plate board (add. charged)

FINISHING

- HDF board covered in PREMIUM or CPL decor
- door leaf edge made in rebated, non-rebated and standard technology

HARDWARE

- rebated door leaf: two or three (PREMIUM decors) pintle hinges, bolt lock
- non-rebated door leaf: three hidden hinges, lock for key, cylinder, economy or bathroom lock
- reverse door leaf: two hidden hinges, lock for key, cylinder, economy or bathroom lock

GLAZING

- BALDUR 1, 3 milk hardened glass 8 mm thick

AVAILABLE DOOR WIDTHS

60 70 80 90 100

ADDITIONAL CHARGES

reverse door leaf **NEW**

filling with solid board

ventilation cut

rebated and non-rebated door leaf 100 wide

additional hinge in rebated door leaf and leaf in Czech Norm, to which always applied (excluding solid board, PREMIUM decors and door leaf 100 wide)

metal hinge casings for rebated door leaf
colour: brushed nickel, patina, polished chrome, polished brass, white and black

PREMIUM



WALNUT
PREMIUM



GREY MAPLE
PREMIUM



OAK
PREMIUM

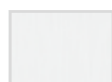

WHITE BARK
PREMIUM



GRAPHITE ASH
PREMIUM

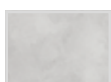

CONCRETE
PREMIUM



DIAGONAL
LARCH

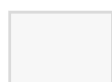

WHITE
PREMIUM¹⁾

CPL



OAK ST CPL



GREY OAK ST CPL



VENGE ST CPL



GREY PINE ST CPL³⁾

TYPES OF EDGE FINISHING



STANDARD



BEZPRZYLGOWA

AVAILABLE SOLUTIONS²⁾ (page 128-130)



DD

Ventilation cut



BALDUR 1



BALDUR 3

¹⁾ white foil imitating painting surface

²⁾ BALDUR 1, 3 - not available for sliding systems

³⁾ available from 1st April 2019

ALTAMURA

NEW



INTERIOR REBATED, NON-REBATED AND REVERSE DOOR LEAFS



ALTAMURA 5
decor OAK ST CPL, MILANO door knob



ALTAMURA 1



ALTAMURA 2



ALTAMURA 3

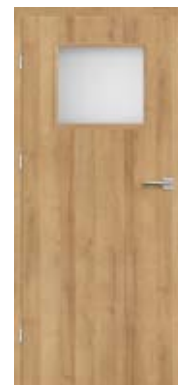

ALTAMURA 4



ALTAMURA 5



ALTAMURA 6



ALTAMURA 7



ALTAMURA 8

CONSTRUCTION

- rebated, non-rebated or reverse door leaf
- MDF rail covered with HDF boards in GREKO and FINISH decors
- inner wooden rail (bottom, upper and sides - mdf) covered with two HDF boards in CPL and PREMIUM decors
- honeycomb core filling or full plate board (add. charged)

FINISHING

- HDF board covered with decor
- door leaf edge made in SOFT (FINISH and GREKO) or STANDARD technology (GREKO, PREMIUM CPL)
- reverse door leaf comes only with STANDARD edge in GREKO, PREMIUM and CPL decors

HARDWARE

- rebated door leaf: two or three (GREKO, PREMIUM) pintle hinges, bolt lock
- non-rebated door leaf: three hidden hinges, lock for key, cylinder, economy or bathroom lock
- reverse door leaf: two hidden hinges, lock for key, cylinder, economy or bathroom lock

GLAZING

- standard comes with decormat: milk or transparent glass** whereas VSG 221 (add. charged) is safety milk glass smooth on both sides
- possibility to modify glazing for REVERSE (OBSERVE in standard glazing)

FINISH



WALNUT FINISH

BRIGHT ACACIA FINISH

ACACIA FINISH

GREKO



WALNUT GREKO

SANREMO GREKO

SONOMA GREKO

MEDIUM OAK GREKO

ELM GREKO

GOLDEN OAK GREKO

GREY OAK GREKO

WHITE PINE GREKO

WHITE GREKO ¹⁾³⁾

BRIGHT WHITE GREKO ¹⁾³⁾

OAK GREKO

CPL



OAK ST CPL

GREY OAK ST CPL

VENGE ST CPL

GREY PINE ST CPL ³⁾

PREMIUM

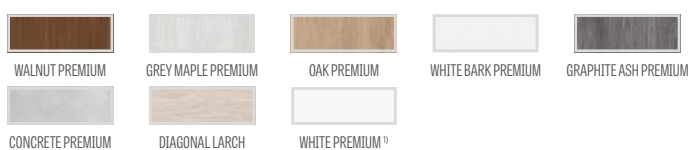

WALNUT PREMIUM

GREY MAPLE PREMIUM

OAK PREMIUM

WHITE BARK PREMIUM

GRAPHITE ASH PREMIUM

CONCRETE PREMIUM

DIAGONAL LARCH

WHITE PREMIUM ¹⁾

ADDITIONAL CHARGES

reverse door leaf NEW

filling with solid board (the third hinge is applied and included in the price of a door leaf)

enforcement for self-lock

door closer

additional bottom construction bar (offers possibility to individual trim of door leaf up to 8 cm)

ventilation cut lub ventilation grill

metal ventilation sleeves, round or square (4 pcs.) finishing brushed nickel, patina, white and black

plastic ventilation sleeves

rebated and non-rebated door leaf 100 wide (the third hinge is applied and included in the price of a door leaf)

VSG 221 milk glass

additional hinge in rebated door leaf and leaf in Czech Norm, to which always applied (excluding solid board, PREMIUM decors and door leaf 100 wide

automatic door seal

metal hinge casings for rebated door leaf
colour: brushed nickel, patina, polished chrome, polished brass, white and black

ALTAMURA 1 offers bull-eye: stainless steel: polished chrome or brushed satin; milk decormat glass, transparent glass, dimensions: diameter inside: 235 mm, outside: 350 mm

AVAILABLE DOOR WIDTHS

60 70 80 90 100

GLAZING PROFILE



AVAILABLE SOLUTIONS (page 119-130)

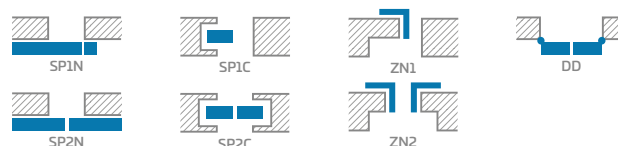

TYPES OF EDGE FINISHING

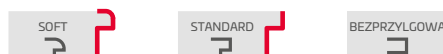

¹⁾ white foil imitating painting surface

²⁾ in SOFT technology the foil is connected on the rebate

³⁾ available from 1st April 2019



ANSEDONIA

NEW



INTERIOR REBATED, NON-REBATED AND REVERSE DOOR LEAFS



ANSEDONIA 4
decor GREY OAK ST CPL, FUTURA INOX door knob



ANSEDONIA 1



ANSEDONIA 2



ANSEDONIA 3



ANSEDONIA 4



ANSEDONIA 5



ANSEDONIA 6



ANSEDONIA 7



ANSEDONIA 8



ANSEDONIA 9



ANSEDONIA 10



ANSEDONIA 11



ANSEDONIA 12



CONSTRUCTION

- rebated, non-rebated or reverse door leaf
- MDF rail covered with HDF boards in GREKO and FINISH decors
- inner wooden rail (bottom, upper and sides - mdf) covered with two HDF boards in CPL and PREMIUM decors
- honeycomb core filling or full plate board (add. charged)

FINISHING

- HDF board covered with decor
- door leaf made in SOFT or STANDARD technology
- reverse door leaf comes only with STANDARD edge in GREKO, PREMIUM and CPL decors

HARDWARE

- rebated door leaf: two or three (GREKO, PREMIUM) pintle hinges, bolt lock
- non-rebated door leaf: three hidden hinges, lock for key, cylinder, economy or bathroom lock
- reverse door leaf: two hidden hinges, lock for key, cylinder, economy or bathroom lock

GLAZING

- standard comes with decormat: milk or transparent glass** whereas VSG 221 (add. charged) is safety milk glass smooth on both sides
- possibility to modify glazing for REVERSE (OBVERSE in standard glazing)

ADDITIONAL CHARGES

reverse door leaf NEW

filling with solid board (the third hinge is applied and included in the price of a door leaf)

enforcement for self-lock

door closer

additional bottom construction bar (offers possibility to individual trim of door leaf up to 8 cm)

ventilation cut lub ventilation grill

plastic ventilation sleeves

metal ventilation sleeves, round or square (4 pcs.) FINISHING brushed nickel, patina, white and black

rebated and non-rebated door leaf 100 wide (the third hinge is applied and included in the price of a door leaf)

VSG 221 milk glass smooth on both sides
price per 1 piece of glass

additional hinge in rebated door leaf and leaf in Czech Norm, to which always applied (excluding solid board, PREMIUM decors and door leaf 100 wide)

automatic door seal

metal hinge casings for rebated door leaf
colour: brushed nickel, patina, polished chrome, polished brass, white and black

FINISH



WALNUT FINISH

BRIGHT ACACIA FINISH

ACACIA FINISH

GREKO



WALNUT GREKO

SANREMO GREKO

SONOMA GREKO

MEDIUM OAK GREKO

ELM GREKO



GOLDEN OAK GREKO

GREY OAK GREKO

WHITE PINE GREKO

WHITE GREKO ¹³⁾

BRIGHT WHITE GREKO ¹²⁾



OAK GREKO

CPL



OAK ST CPL

GREY OAK ST CPL

VENGE ST CPL

GREY PINE ST CPL ³⁾

PREMIUM



WALNUT PREMIUM

GREY MAPLE PREMIUM

OAK PREMIUM

WHITE BARK PREMIUM

GRAPHITE ASH PREMIUM



CONCRETE PREMIUM

DIAGONAL LARCH

WHITE PREMIUM ¹⁾

AVAILABLE DOOR WIDTHS

60 70 80 90 100

GLAZING PROFILE



AVAILABLE SOLUTIONS (page 119-130)

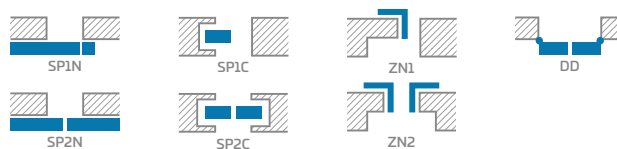

TYPES OF EDGE FINISHING

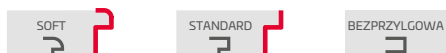

¹⁾ white foil imitating painting surface

²⁾ in SOFT technology the foil is connected on the rebate

³⁾ available from 1st April 2019



LORIENT

NEW



INTERIOR REBATED, NON-REBATED AND REVERSE DOOR LEAFS



LORIENT 1
decor GREY MAPLE PREMIUM, FUTURA INOX door knob



LORIENT 1



LORIENT 2



LORIENT 3



LORIENT 4



LORIENT 5



LORIENT 6



LORIENT 7



LORIENT 8



LORIENT 9



LORIENT 10



LORIENT 11



LORIENT 12



CONSTRUCTION

- rebated, non-rebated or reverse door leaf
- MDF rail covered with HDF boards in GREKO and FINISH decors
- inner wooden rail (bottom, upper and sides - mdf) covered with two HDF boards in CPL and PREMIUM decors
- honeycomb core filling or full plate board (add. charged)

FINISHING

- HDF board covered with decor
- door leaf made in SOFT or STANDARD technology
- reverse door leaf comes only with STANDARD edge in GREKO, PREMIUM and CPL decors

HARDWARE

- rebated door leaf: two or three (GREKO, PREMIUM) pintle hinges, bolt lock
- non-rebated door leaf: three hidden hinges, lock for key, cylinder, economy or bathroom lock
- reverse door leaf: two hidden hinges, lock for key, cylinder, economy or bathroom lock

GLAZING

- **standard comes with decormat: milk or transparent glass** whereas VSG 221 (add. charged) is safety milk glass smooth on both sides
- possibility to modify glazing for REVERSE (OBVERSE in standard glazing)

ADDITIONAL CHARGES

reverse door leaf NEW

filling with solid board (the third hinge is applied and included in the price of a door leaf)

enforcement for self-lock

door closer

additional bottom construction bar (offers possibility to individual trim of door leaf up to 8 cm)

ventilation cut lub ventilation grill

plastic ventilation sleeves

metal ventilation sleeves, round or square (4 pcs.) FINISHING brushed nickel, patina, white and black

rebated and non-rebated door leaf 100 wide (the third hinge is applied and included in the price of a door leaf)

VSG 221 milk glass smooth on both sides

additional hinge in rebated door leaf and leaf in Czech Norm, to which always applied (excluding solid board, PREMIUM decors and door leaf 100 wide)

automatic door seal

metal hinge casings for rebated door leaf
colour: brushed nickel, patina, polished chrome, polished brass, white and black

FINISH



WALNUT FINISH BRIGHT ACACIA FINISH ACACIA FINISH

GREKO

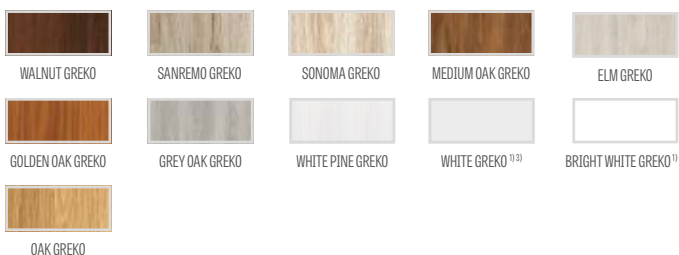

WALNUT GREKO SANREMO GREKO SONOMA GREKO MEDIUM OAK GREKO ELM GREKO
GOLDEN OAK GREKO GREY OAK GREKO WHITE PINE GREKO WHITE GREKO ¹⁾ BRIGHT WHITE GREKO ¹⁾
OAK GREKO

CPL



OAK ST CPL GREY OAK ST CPL VENGE ST CPL GREY PINE ST CPL ³⁾

PREMIUM

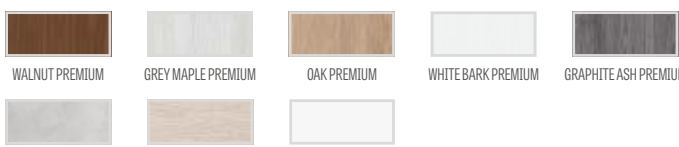

WALNUT PREMIUM GREY MAPLE PREMIUM OAK PREMIUM WHITE BARK PREMIUM GRAPHITE ASH PREMIUM
CONCRETE PREMIUM DIAGONAL LARCH WHITE PREMIUM ¹⁾

AVAILABLE DOOR WIDTHS

60 70 80 90 100

GLAZING PROFILE



AVAILABLE SOLUTIONS (page 119-130)

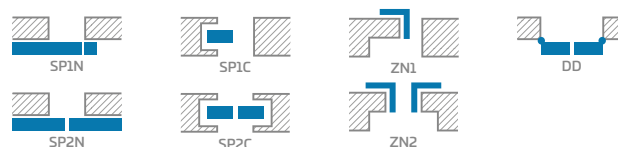

TYPES OF EDGE FINISHING

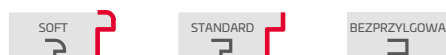

¹⁾ white foil imitating painting surface

²⁾ in SOFT technology the foil is connected on the rebate

³⁾ available from 1st April 2019



MENTON

NEW



INTERIOR REBATED, NON-REBATED AND REVERSE DOOR LEAFS



MENTON 1
decor GREY OAK GREKO, ERKADO black matt door knob



MENTON 1



MENTON 2



MENTON 3



MENTON 4



MENTON 5



MENTON 6



MENTON 7



MENTON 8



MENTON 9



MENTON 10



MENTON 11



MENTON 12



CONSTRUCTION

- rebated, non-rebated or reverse door leaf
- MDF rail covered with HDF boards in GREKO and FINISH decors
- inner wooden rail (bottom, upper and sides - mdf) covered with two HDF boards in CPL and PREMIUM decors
- honeycomb core filling or full plate board (add. charged)

FINISHING

- HDF board covered with decor
- door leaf made in SOFT or STANDARD technology
- reverse door leaf comes only with STANDARD edge in GREKO, PREMIUM and CPL decors

HARDWARE

- rebated door leaf: two or three (GREKO, PREMIUM) pintle hinges, bolt lock
- non-rebated door leaf: three hidden hinges, lock for key, cylinder, economy or bathroom lock
- reverse door leaf: two hidden hinges, lock for key, cylinder, economy or bathroom lock

GLAZING

- **standard comes with decormat: milk or transparent glass** whereas VSG 221 (add. charged) is safety milk glass smooth on both sides
- possibility to modify glazing for REVERSE (OBVERSE in standard glazing)

ADDITIONAL CHARGES

reverse door leaf NEW

filling with solid board (the third hinge is applied and included in the price of a door leaf)

enforcement for self-lock

door closer

additional bottom construction bar (offers possibility to individual trim of door leaf up to 8 cm)

ventilation cut lub ventilation grill

metal ventilation sleeves, round or square (4 pcs.) FINISHING brushed nickel, patina, white and black

plastic ventilation sleeves

rebated and non-rebated door leaf 100 wide (the third hinge is applied and included in the price of a door leaf)

VSG 221 milk glass

additional hinge in rebated door leaf and leaf in Czech Norm, to which always applied (excluding solid board, PREMIUM decors and door leaf 100 wide)

automatic door seal

metal hinge casings for rebated door leaf
colour: brushed nickel, patina, polished chrome, polished brass, white and black

FINISH

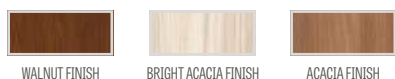

WALNUT FINISH

BRIGHT ACACIA FINISH

ACACIA FINISH

GREKO



WALNUT GREKO

SANREMO GREKO

SONOMA GREKO

MEDIUM OAK GREKO

ELM GREKO

GOLDEN OAK GREKO

GREY OAK GREKO

WHITE PINE GREKO

WHITE GREKO ¹⁾

BRIGHT WHITE GREKO ¹⁾

OAK GREKO

CPL



OAK ST CPL

GREY OAK ST CPL

VENGE ST CPL

GREY PINE ST CPL ³⁾

PREMIUM



WALNUT PREMIUM

GREY MAPLE PREMIUM

OAK PREMIUM

WHITE BARK PREMIUM

GRAPHITE ASH PREMIUM

CONCRETE PREMIUM

DIAGONAL LARCH

WHITE PREMIUM ¹⁾

AVAILABLE DOOR WIDTHS

60 70 80 90 100

GLAZING PROFILE



AVAILABLE SOLUTIONS (page 119-130)

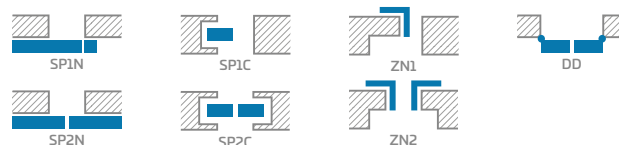

TYPES OF EDGE FINISHING

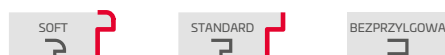

¹⁾ white foil imitating painting surface

²⁾ in SOFT technology the foil is connected on the rebate

³⁾ available from 1st April 2019

SORANO

NEW



INTERIOR REBATED, NON-REBATED AND REVERSE DOOR LEAFS



SORANO 1
decor VENGE ST CPL, FUTURA INOX door knob



SORANO 1



SORANO 2



SORANO 3



SORANO 4



SORANO 5



SORANO 6



SORANO 7



SORANO 8



SORANO 9



SORANO 10



SORANO 11



SORANO 12

CONSTRUCTION

- rebated, non-rebated or reverse door leaf
- MDF rail covered with HDF boards in GREKO and FINISH decors
- inner wooden rail (bottom, upper and sides - mdf) covered with two HDF boards in CPL and PREMIUM decors
- honeycomb core filling or full plate board (add. charged)

FINISHING

- HDF board covered with decor
- door leaf made in SOFT or STANDARD technology
- reverse door leaf comes only with STANDARD edge in GREKO, PREMIUM and CPL decors

HARDWARE

- rebated door leaf: two or three (GREKO, PREMIUM) pintle hinges, bolt lock
- non-rebated door leaf: three hidden hinges, lock for key, cylinder, economy or bathroom lock
- reverse door leaf: two hidden hinges, lock for key, cylinder, economy or bathroom lock

GLAZING

- standard comes with decormat: milk or transparent glass** whereas VSG 221 (add. charged) is safety milk glass smooth on both sides
- possibility to modify glazing for REVERSE (OBVERSE in standard glazing)

ADDITIONAL CHARGES

reverse door leaf NEW

filling with solid board (the third hinge is applied and included in the price of a door leaf)

enforcement for self-lock

door closer

additional bottom construction bar (offers possibility to individual trim of door leaf up to 8 cm)

ventilation cut lub ventilation grill

metal ventilation sleeves, round or square (4 pcs.) FINISHING brushed nickel, patina, white and black

plastic ventilation sleeves

rebated and non-rebated door leaf 100 wide (the third hinge is applied and included in the price of a door leaf)

VSG 221 milk glass

additional hinge in rebated door leaf and leaf in Czech Norm, to which always applied (excluding solid board, PREMIUM decors and door leaf 100 wide)

automatic door seal

metal hinge casings for rebated door leaf
colour: brushed nickel, patina, polished chrome, polished brass, white and black

FINISH



WALNUT FINISH



BRIGHT ACACIA FINISH



ACACIA FINISH

GREKO



WALNUT GREKO



SANREMO GREKO



SONOMA GREKO



MEDIUM OAK GREKO



ELM GREKO



GOLDEN OAK GREKO



GREY OAK GREKO



WHITE PINE GREKO

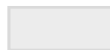

WHITE GREKO ¹⁾



BRIGHT WHITE GREKO ¹⁾



OAK GREKO

CPL



OAK ST CPL



GREY OAK ST CPL



VENGE ST CPL



GREY PINE ST CPL ³⁾

PREMIUM



WALNUT PREMIUM



GREY MAPLE PREMIUM



OAK PREMIUM

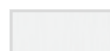

WHITE BARK PREMIUM



GRAPHITE ASH PREMIUM



CONCRETE PREMIUM



DIAGONAL LARCH

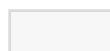

WHITE PREMIUM ¹⁾

AVAILABLE DOOR WIDTHS

60 70 80 90 100

GLAZING PROFILE



AVAILABLE SOLUTIONS (page 119-130)



SP1N



SP1C



ZN1



DD



SP2N

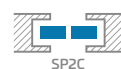

SP2C



ZN2

TYPES OF EDGE FINISHING



SOFT



STANDARD



BEZPRZYLGOWA

¹⁾ white foil imitating painting surface

²⁾ in SOFT technology the foil is connected on the rebate

³⁾ available from 1st April 2019



FORTECA RC3
decor GRAPHITE ASH PREMIUM

FORTECA RC2 and RC3



ANTI BURGLARY ENTRANCE DOORS CLASS RC2 AND RC3



2 HOOK RAFTERS



ANTI BURGLARY UPPER AND BOTTOM LOCKS



FOUR LOCK PLATES with regulation

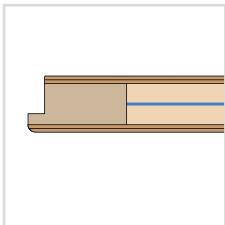

THICKNESS 46 mm enforced with steel sheet

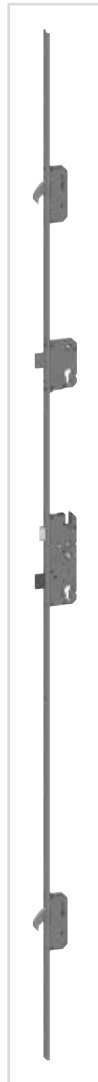

PANEL LOCK



ACOUSTIC ISOLATION
37dB



4 PINTLE HINGES Ø16 WITH 3D REGULATION



4 ANTI BURGLARY CONTACT BOLTS



FIXED FRAME wooden in RC2 or enforced in RC3



THRESHOLD OF HARD WOOD (transparent lacquer)



FORTECA RC2



FORTECA RC3



PEEP HOLE



THRESHOLD MADE OF STAINLESS STEEL

INTERSECTION OF FORTECA DOOR LEAF

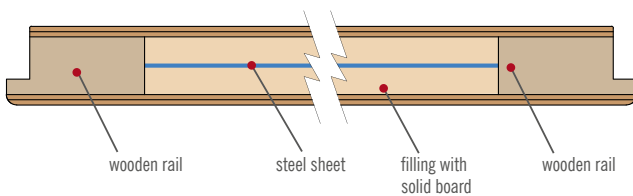

THRESHOLD OF HARD WOOD

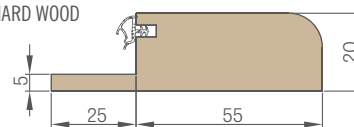

THRESHOLD OF STAINLESS STEEL

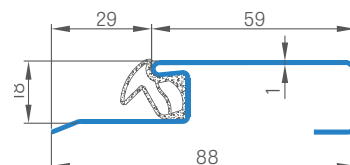

FORTECA RC2

NEW



ANTI BURGLARY REBATED DOORS CLASS RC2 OPENING INSIDE AND OUTSIDE



Presented model: FORTECA RC2 in OAK ST CPL

GENERAL INFORMATION

- doors FORTECA RC2 opening inside or outside have the acoustic insulation $R_w=37$ dB, anti burglary class RC2 acc. to PN EN 1627:2012 and 5th class of mechanical durability
- doors are available only in GOLD SET, together with possible mounting
- doors are applicable as entrance staircase

CONSTRUCTION

- wooden rail covered with glued HDF boards
- filling with dedicated solid board
- enforcement of whole door leaf with steel sheet
- thickness of door leaf 46 mm

FINISHING

- door leaf edge made in standard technology
- HDF board covered with FINISH, GREKO, PREMIUM and CPL decors

HARDWARE

- four silver hinges $\varnothing 16$ with 3D regulation
- four-point anti burglary panel lock with two cylinders in standard
- four anti burglary bolts on the hinge side

FIXED REBATED DOOR FRAME

- fixed wooden frame covered with MDF boards
- mounting is possible within the range 90-450 mm every 20 mm
- adjustable upper lock plate in the frame and two adjustable lock plates for the hook and additional lock

GOLD SET

- FORTECA RC2 in GOLD SET are already assembled and have steel or wooden threshold fixed, panel lock and have drills ready to fix anti burglary door knob and upper lock face

GOLD SET INCLUDES

- door leaf with wooden frame with steel or wooden threshold assembled and ready for installation
- anti burglary four-point hook panel lock with two cylinders with hook press system
- anti burglary door knob and upper face lock FORTECA RC2 in silver colour
- anti burglary cylinders (upper with knob) in one-key system in silver colour
- peep-hole (drilling to be done individually)

AVAILABLE DOOR WIDTHS

80 80N 90 100

TYPES OF EDGE FINISHING



GREKO

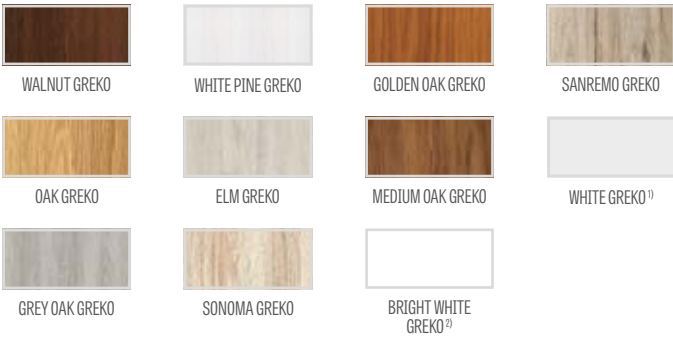

FINISH

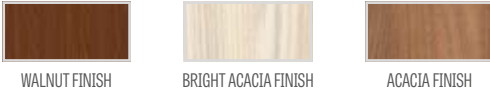

PREMIUM



CPL

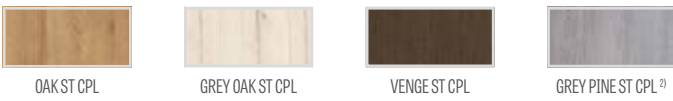

¹⁾ white foil imitating painting surface
²⁾ available from 1st April 2019

CHARGES

door 100 wide

metal hinge casings (nickel satin, patina)

wall mounting every 20 cm
 range 90 mm to 450 mm

wall mounting comes with the square 6 cm. Masking trim 6 cm
 additionally charged, p. 145

trimming door leaf up to 8 cm, every 1 cm

track door closer

INTERSECTION OF FIXED FRAME FORTECA RC2

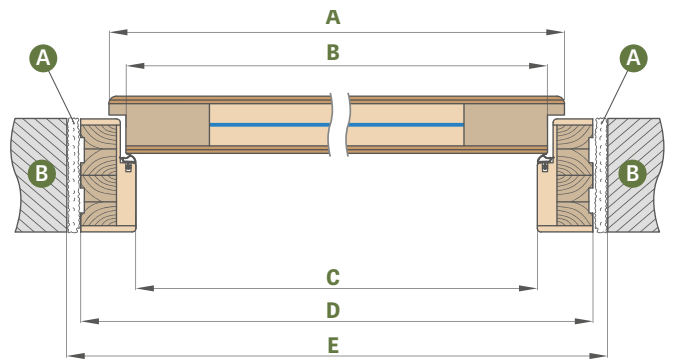
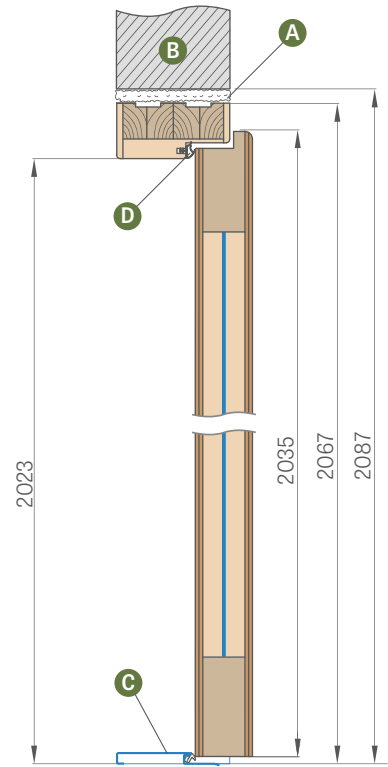

Width of door leaf	A	B	C	D	E
„80N“	804	778	761	849	889
„80“	854	828	811	899	939
„90“	954	928	911	999	1039
„100“	1054	1028	1011	1099	1139

- A** – mounting foam
- B** – wall
- C** – threshold of stainless steel or wooden
- D** – rubber seal

WALL MOUNTING

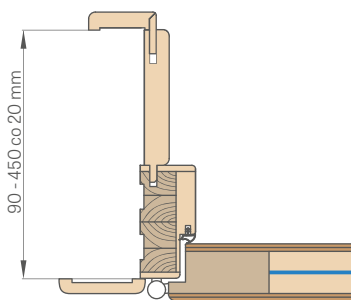

FIXED FRAME

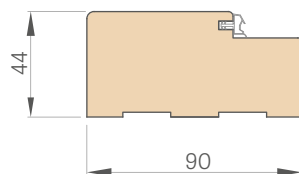

MASKING TRIM

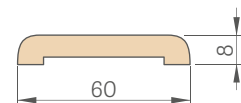

QUARTER ROUND

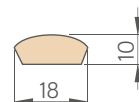

FORTECA RC3

NEW



ANTI BURGLARY REBATED DOORS CLASS RC3 OPENING INSIDE AND OUTSIDE



Presented model: FORTECA RC3 in OAK ST CPL

GENERAL INFORMATION

- doors FORTECA RC3 opening inside or outside have the acoustic insulation $R_w=37$ dB, anti burglary class RC3 acc. to PN EN 1627:2012 and 5th class of mechanical durability
- doors are available only in GOLD SET, together with possible mounting
- doors are applicable as entrance staircase

CONSTRUCTION

- wooden rail covered with glued HDF boards
- filling with dedicated solid board
- enforcement of whole door leaf with steel sheet
- thickness of door leaf 46 mm

FINISHING

- door leaf edge made in standard technology
- HDF board covered with FINISH, GREKO, PREMIUM and CPL decors

HARDWARE

- four silver hinges $\varnothing 16$ with 3D regulation
- four-point anti burglary panel lock with two cylinders in standard
- four anti burglary bolts on the hinge side

FIXED REBATED DOOR FRAME

- fixed wooden frame covered with MDF boards
- mounting is possible within the range 90-450 mm every 20 mm
- adjustable main lock plate in the frame and two adjustable lock plates for the hooks and additional lock

GOLD SET

- FORTECA RC3 in GOLD SET are already assembled and have steel or wooden threshold fixed, panel lock and have drills ready to fix door knob and upper lock face

GOLD SET INCLUDES

- door leaf with wooden frame with steel or wooden threshold assembled and ready for installation
- anti burglary four-point hook panel lock with two cylinders with hook press system
- anti burglary door knob and upper face lock FORTECA RC3 in silver colour
- anti burglary cylinders (upper with knob) in one-key system in silver colour
- peep-hole (drilling to be done individually)

AVAILABLE DOOR WIDTHS

80 80N 90 100

TYPES OF EDGE FINISHING

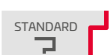

GREKO

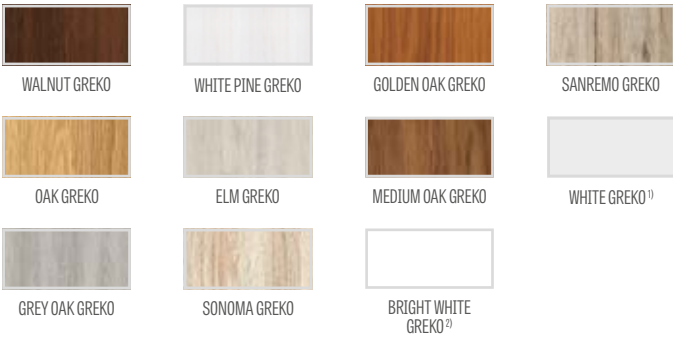

FINISH

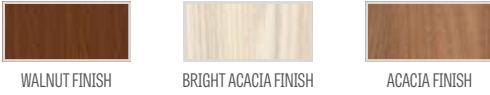

PREMIUM



CPL



¹⁾ white foil imitating painting surface
²⁾ available from 1st April 2019

CHARGES

door 100 wide

metal hinge casings (nickel satin, patina)

wall mounting every 20 cm
 range 90 mm to 450 mm

wall mounting comes with the square 6 cm. Masking trim 6 cm
 additionally charged, p. 145

trimming door leaf up to 8 cm, every 1 cm

track door closer

INTERSECTION OF FIXED FRAME FORTECA RC3

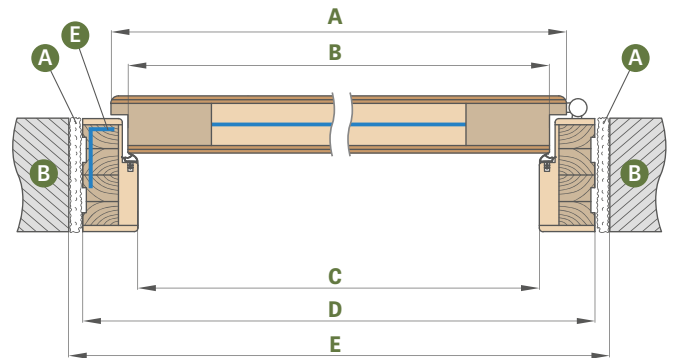
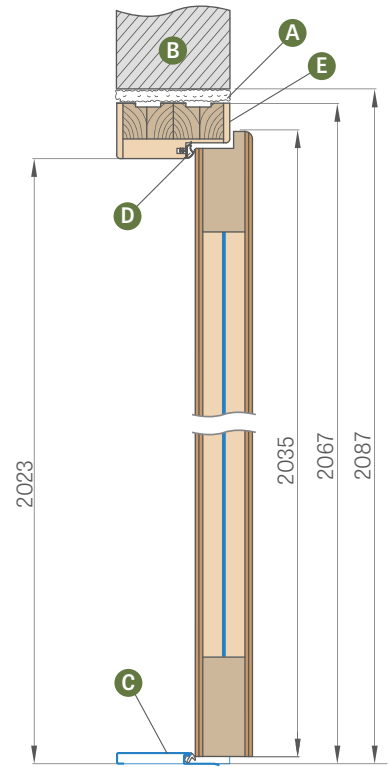

Width of door leaf	A	B	C	D	E
„80N“	804	778	761	849	889
„80“	854	828	811	899	939
„90“	954	928	911	999	1039
„100“	1054	1028	1011	1099	1139

- A** – mounting foam
- B** – wall
- C** – threshold of stainless steel or wooden
- D** – rubber seal
- E** – additional inside enforcement of frame with steel square (from lock plates side)

WALL MOUNTING

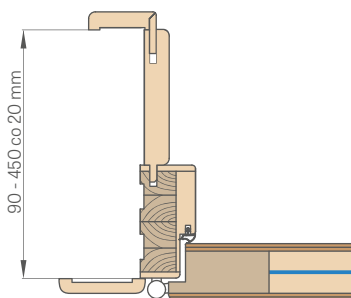

FIXED FRAME

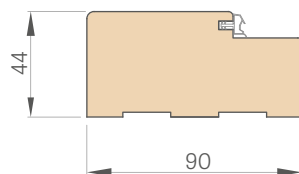

MASKING TRIM

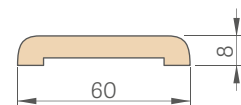

QUARTER ROUND

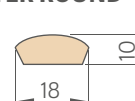

HERSE SET



ENTRANCE DOOR LEAF WITH ANTI-BURGLARY LOCKS

Presented model: HERSE SET in WALNUT FINISH decor with ESSEN door knob



GENERAL INFORMATION

- HERSE SET door leaf is used in the housing and public utility as the entrance door (excluding door leaf 80N).
- HERSE door leaf together with the fixed frame, stainless steel or hard wood (not painted) threshold or an automatic seal has the insulating power of $R_w = 32\text{dB}$.
- HERSE SET door leaf in GOLD and SILVER SETS are already assembled as one piece and together with installed threshold whereas in GOLD SET there are holes for door knob and upper lock face assembly ready.

CONSTRUCTION

- MDF rails covered with two HDF boards
- filling with dedicated solid board
- enforcement with massive iron profile
- thickness 46 mm
- additional gasket

FINISHING

- door leaf made in SOFT, STANDARD or SOFT PCV technology
- HDF board covered with FINISH foil, CPL, PREMIUM, GREKO or PCV TWIN
- doors can be cut up to 8 cm by Erkado
- possibility to select only lower latch lock

HARDWARE

- three silver hinges $\varnothing 16$ with 3D regulation
- two three-bolt anti-burglary locks in class 2 for cylinder (price includes optional change of lower lock only)
- three anti burglary contact bolts on the hinge side

FIXED AND ADJUSTABLE REBATED HERSE DOOR FRAME

- possible application of electric strike in frame for lower lock [that excludes upper lock in a door leaf]
- main plate in frames is regulated

AVAILABLE DOOR WIDTHS

80	90	100	80N	available only in PCV decor and fixed or iron frame
----	----	-----	-----	---

TYPES OF EDGE FINISHING



GOLD SET
SILVER SET

Door leaf with wooden fixed frame, stainless steel threshold and hardware⁴⁾

Door leaf with wooden fixed frame, stainless steel threshold without hardware⁴⁾

ADDITIONAL CHARGES

peep-hole

threshold of hard wood (transparent lacquer) with seal 55 mm thick or threshold of stainless steel with seal

threshold made of hard wood to adjustable frame

door closer

Track door closer

enforcement for self-lock

automatic door seal

trimming door leaf (door leaf and frame) up to 8 cm trimmed by 1 cm

door leaf or set 100

cylinder 30/45

cylinder-holder 30G/45 or 30/45G

cylinder 30/45 and cylinder-holder 30G/45 or 30/45G in one-key system

metal hinge casings (nickel satin, patina)

ESSEN door knob (nickel satin)

ESSEN knob face (nickel satin)

¹⁾ white foil imitating painting surface

²⁾ in SOFT technology the foil is connected on the rebate

³⁾ only STANDARD edge

⁴⁾ hardware set: ESSEN door knob nickel satin, upper lock plate, cylinders in 1-key system (upper with knob), peep-hole (without drilled hole)

⁵⁾ available from 1st April 2019

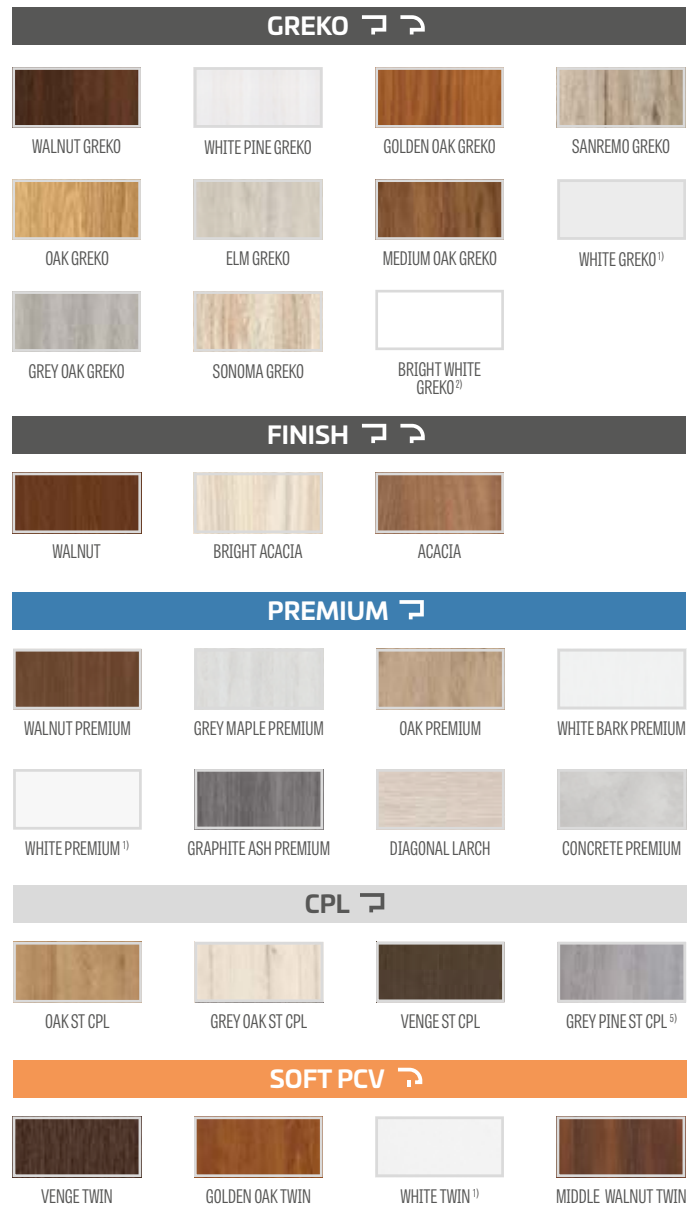

HERSE LUX SET



ENTRANCE DOOR LEAF WITH ANTI-BURGLARY LOCKS

Presented model: HERSE LUX SET 4 in WALNUT GREKO decor with ESSEN door knob



GENERAL INFORMATION

- HERSE LUX SET door leaf is used in the housing and public utility as the entrance door (excluding door leaf 80N).
- HERSE door leaf together with the fixed frame, stainless steel or hard wood (not painted) threshold or an automatic seal has the insulating power of $R_w = 32\text{dB}$.
- HERSE LUX SET door leaf in GOLD and SILVER SETS are already assembled as one piece and together with installed threshold whereas in GOLD SET they are holes for door knob and upper lock face assembly ready.

CONSTRUCTION

- MDF rails covered with two HDF boards
- filling with dedicated solid board
- enforcement with massive iron profile
- thickness 46 mm
- additional gasket

FINISHING

- door leaf made in SOFT, STANDARD or SOFT PCV technology
- HDF board covered with FINISH foil, CPL, PREMIUM, GREKO or PCV TWIN
- aluminium profiles (8 mm) on both sides of door leaf
- doors can be cut up to 8 cm by Erkado
- possibility to select only lower latch lock

HARDWARE

- three screw 3D regulated pintle hinges
- two three-bolt anti-burglary locks in class 2 for cylinder (price includes optional change of lower lock only)
- three anti burglary contact bolts on the hinge side

FIXED AND ADJUSTABLE REBATED HERSE DOOR FRAME

- possible application of electric strike in frame for lower lock [what excludes upper lock in a door leaf]
- main plate in frames is regulated

AVAILABLE DOOR WIDTHS

80	90	100	80N	available only in PCV decor and fixed or iron frame
----	----	-----	-----	---

TYPES OF EDGE FINISHING



GOLD SET
SILVER SET

Door leaf with wooden fixed frame, stainless steel threshold and hardware⁴⁾

Door leaf with wooden fixed frame, stainless steel threshold without hardware⁴⁾

ADDITIONAL CHARGES

peep-hole

threshold of hard wood (transparent lacquer) with seal 55 mm thick or threshold of stainless steel with seal

threshold made of hard wood to adjustable frame

door closer

Track door closer

enforcement for self-lock

automatic door seal

trimming door leaf (door leaf and frame) up to 8 cm trimmed by 1 cm

door leaf or set 100

cylinder 30/45

cylinder-holder 30G/45 or 30/45G

cylinder 30/45 and cylinder-holder 30G/45 or 30/45G in one-key system

metal hinge casings (nickel satin, patina)

ESSEN door knob (nickel satin)

ESSEN knob face (nickel satin)

¹⁾ white foil imitating painting surface

²⁾ in SOFT technology the foil is connected on the rebate

³⁾ only STANDARD edge

⁴⁾ hardware set: ESSEN door knob nickel satin, upper lock plate, cylinders in 1-key system (upper with knob), peep-hole (without drilled hole)

⁵⁾ available from 1st April 2019



HERSE LUX SET 1



HERSE LUX SET 3



HERSE LUX SET 4



HERSE LUX SET 10



HERSE LUX SET 11



HERSE LUX SET 12

GREKO ↗ ↘



WALNUT GREKO



WHITE PINE GREKO



GOLDEN OAK GREKO



SANREMO GREKO



OAK GREKO



ELM GREKO



MEDIUM OAK GREKO



WHITE GREKO ¹⁾



GREY OAK GREKO



SONOMA GREKO



BRIGHT WHITE GREKO ²⁾

FINISH ↗ ↘



WALNUT



BRIGHT ACACIA



ACACIA

PREMIUM ↗ ↘



WALNUT PREMIUM



GREY MAPLE PREMIUM



OAK PREMIUM



WHITE BARK PREMIUM

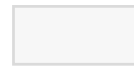

WHITE PREMIUM ¹⁾



GRAPHITE ASH PREMIUM



DIAGONAL LARCH



CONCRETE PREMIUM

CPL ↗ ↘



OAK ST CPL



GREY OAK ST CPL



VENGE ST CPL



GREY PINE ST CPL ⁵⁾

SOFT PCV ↗ ↘



VENGE TWIN



GOLDEN OAK TWIN

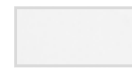

WHITE TWIN ¹⁾



MIDDLE WALNUT TWIN

HERSE MAX SET



ENTRANCE DOOR LEAF WITH ANTI-BURGLARY LOCKS

Presented model: HERSE MAX SET 1 in GOLDEN OAK TWIN decor with ESSEN door knob



GENERAL INFORMATION

- HERSE SET door leaf is used in the housing and public utility as the entrance door (excluding door leaf 80N).
- HERSE door leaf together with the fixed frame, stainless steel or hard wood (not painted) threshold or an automatic seal has the insulating power of $R_w = 32\text{dB}$.
- HERSE MAX SET door leaf in GOLD and SILVER SETS are already assembled as one piece and together with installed threshold whereas in GOLD SET they are holes for door knob and upper lock face assembly ready.

CONSTRUCTION

- MDF rails covered with two HDF boards
- filling with dedicated solid board
- enforcement with massive iron profile
- thickness 46 mm
- additional seal

FINISHING

- door leaf made in SOFT PCV technology
- milled HDF covered with PCV TWIN decor
- milling details are presented at page 118
- doors can be cut up to 8 cm by Erkado

HARDWARE

- three screw 3D regulated pintle hinges
- two three-bolt anti-burglary locks in class 2 for cylinder (price includes optional change of lower lock only)
- three anti burglary contact bolts on the hinge side

FIXED AND ADJUSTABLE REBATED DOOR FRAME

- possible application of electric strike in frame for lower lock [what excludes upper lock in a door leaf]
- main plate in frames is regulated

SOFT PCV



VENGE TWIN



GOLDEN OAK TWIN

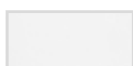

WHITE TWIN¹⁾



MIDDLE WALNUT TWIN

PAKIET GOLD Door leaf with wooden fixed frame, stainless steel threshold and hardware ⁴⁾

PAKIET SILVER Door leaf with wooden fixed frame, stainless steel threshold without hardware ⁴⁾

TYPES OF EDGE FINISHING



¹⁾ white foil imitating painting surface

⁴⁾ hardware set: ESSEN door knob nickel satin, upper lock plate, cylinders in 1-key system (upper with knob), peep-hole (without drilled hole)

ADDITIONAL CHARGES

peep-hole

threshold made of hard wood, with seal, 55 mm thick or stainless steel threshold with seal

threshold made of hard wood to adjustable frame

door closer

track door closer

enforcement for self-lock

automatic door seal

trimming door leaf (door leaf and frame) up to 8 cm trimmed by 1 cm

cylinder 30/45

cylinder-holder 30G/45 or 30/45G

cylinder 30/45 and cylinder-holder 30G/45 or 30/45G in one-key system

metal hinge casings (nickel satin, patina)

ESSEN door knob (nickel satin)

ESSEN knob face (nickel satin)

AVAILABLE DOOR WIDTHS

80

90

80N

available only in fixed or iron frame



HERSE MAX SET 1



HERSE MAX SET 2



HERSE MAX SET 3



HERSE MAX SET 6



HERSE MAX SET 7



HERSE MAX SET 13



HERSE MAX SET 14



HERSE MAX SET 22



FIXED AND ADJUSTABLE FRAME

HERSE SET, HERSE LUX SET, HERSE MAX SET

TECHNICAL PICTURE OF HERSE FIXED FRAME

TECHNICAL PICTURE OF HERSE ADJUSTABLE FRAME

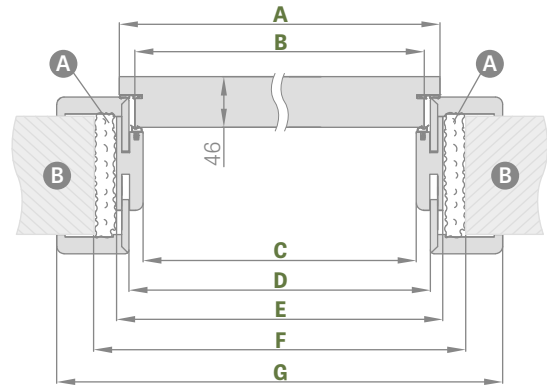
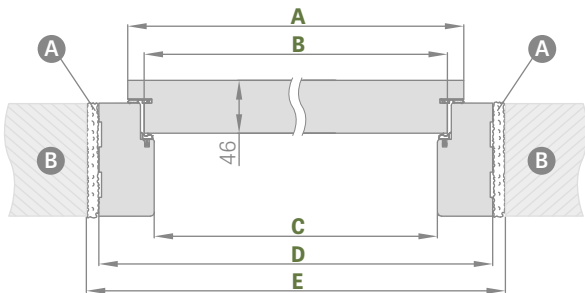
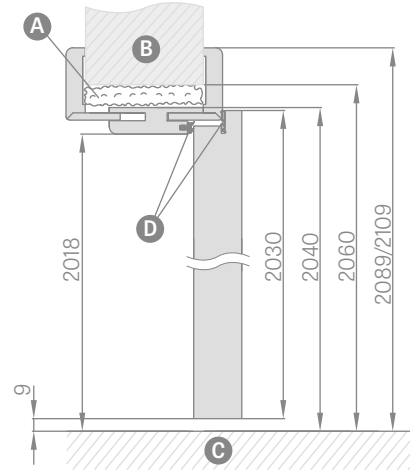
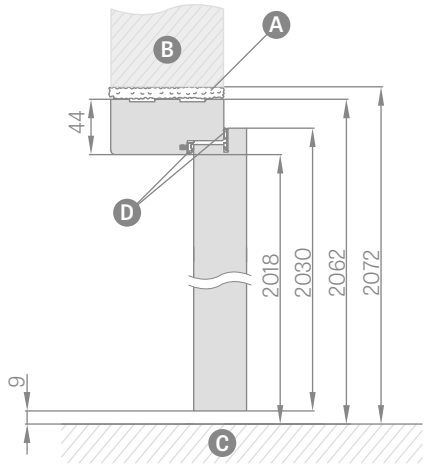

Width of door leaf	A	B	C	D	E
„80N“	804	777	764	852	872
„80“	844	817	804	892	912
„90“	944	917	904	992	1012
„100“ ¹⁾	1044	1017	1004	1092	1112

Width of door leaf	A	B	C	D	E	F	G
„80“	844	817	804	826	848	888	946*/986**
„90“	944	917	904	926	948	988	1046*/1086**
„100“ ¹⁾	1044	1017	1004	1026	1048	1088	1146*/1186**

* adjustable cover with 60 masking trim / **adjustable cover with 80 masking trim

- A** – mounting foam
- B** – wall
- C** – floor
- D** – rubber seal

¹⁾ not applicable to HERSE SET MAX

FIXED AND ADJUSTABLE FRAME

	Adjustment range min.-max (mm)
1 elements	80-100
	100-120
	120-140
	140-160
	160-180
	180-200
	200-220
	220-240
	240-260
	260-280
2 elements	260-300
	280-300
	300-320
	320-340
	340-360
3 elements	360-380
	380-400
	400-420

- Connecting the adjustable frame to an angle of 90 degrees is possible only with the list cover 8 cm thick.

RANGE OF ADJUSTABLE FRAME

Adj. cover list 6 cm / Adj. cover list 8 cm

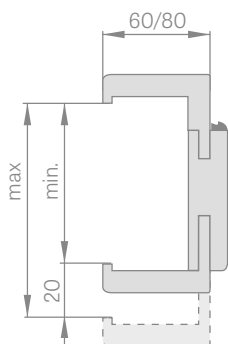

FIXED FRAME

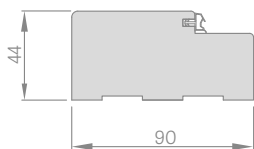

ADJUSTABLE WOODEN THRESHOLD

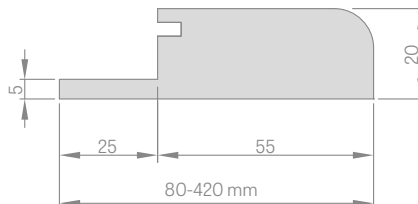

MASKING TRIM

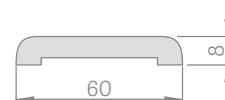

QUARTER ROUND

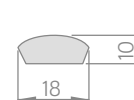



METAL FRAMES

HERSE SET, HERSE LUX SET, HERSE MAX SET

METAL FIXED FRAME CASING TYPE TO HERSE SET

welded and painted RAL 9010, 9016, 8003, 8017, 7016, 7047, 1001

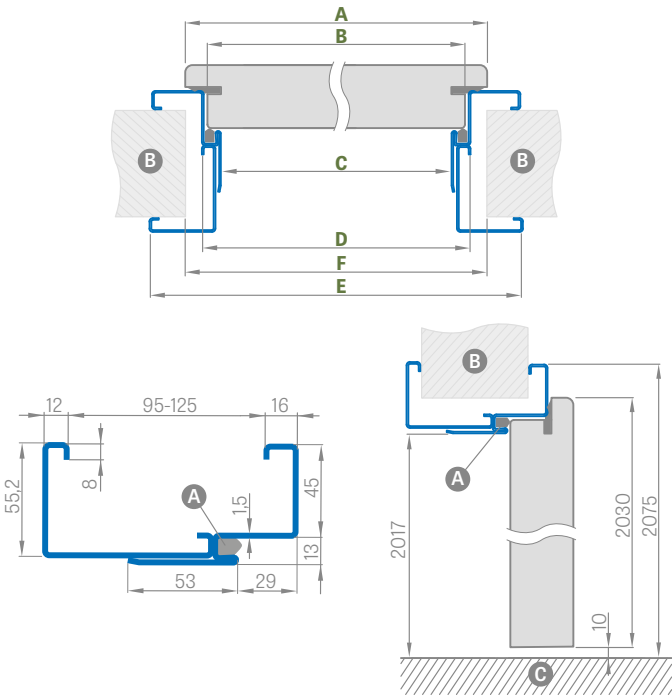

Width of door leaf	A	B	C	D	E	F
„80N“	804	777	761	787	877	855
„80“	844	817	801	827	917	895
„90“	944	917	901	927	1017	995
„100“ ¹⁾	1044	1017	1001	1027	1117	1095

Adjustment range min.-max (mm)
95-125
125-155
155-185
185-215
215-245
245-275
275-305

METAL SQUARE FRAME, LARGE SIZE TO HERSE SET

welded and painted RAL 9010, 9016, 8003, 8017, 7016, 7047, 1001

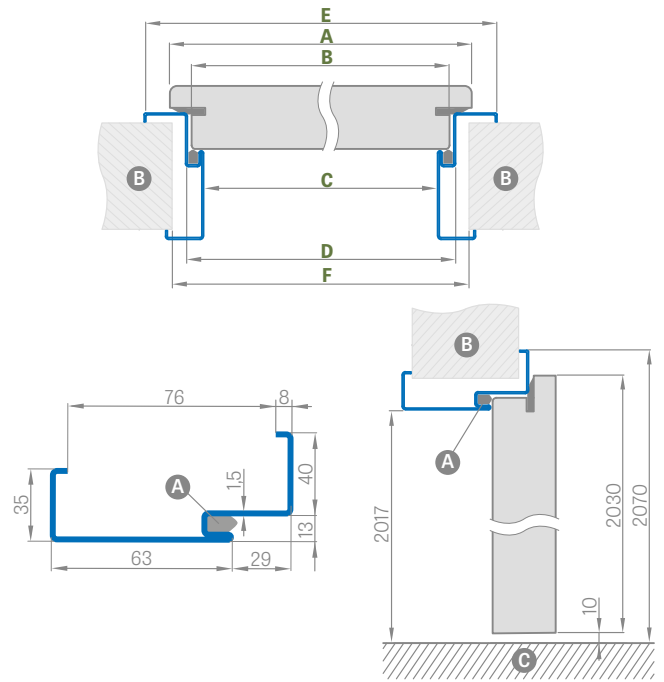

Width of door leaf	A	B	C	D	E	F
„80N“	804	777	761	787	867	843
„80“	844	817	801	827	907	883
„90“	944	917	901	927	1007	983
„100“ ¹⁾	1044	1017	1001	1027	1107	1083

LAUNCHING EDGE FRAME

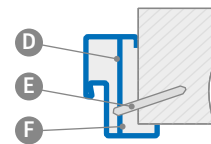

- A** – rubber seal
- B** – wall
- C** – floor
- D** – assembly anchor
- E** – expansion bolt
- F** – filler

ADDITIONAL CHARGES

large square frame 100 wide

electric strike

enforcement for self-lock

threshold made of stainless steel

finishing with galvanised steel

RAL



RAL 9010 RAL 9016 RAL 8003 RAL 8017 RAL 7016 RAL 7047 RAL 1001

¹⁾ not applicable to HERSE SET MAX

LEDA EI30, EI60



INTERIOR FIRE PROTECTION ENTRANCE DOOR MADE IN HALSPAN TECHNOLOGY

Presented model: LEDA EI30 in WALNUT decor with STANDARD INOX door knob



GENERAL INFORMATION

The proper performance of the functions such as fire protection, intumescent and acoustic are provided only when assembling the whole set. The complete set includes: fire protection door leaf (pre-equipped with gaskets, locks, hinges, falling gasket) frame, overhead doorcloser and door lock cylinder and door handle all accordant to Polish Norm.

Acoustic isolation of HALSPAN door leaf together with falling gasket according to PN-B-02151-03:1999 is $R_w=32\text{dB}$

Leda door leaf is sold only in a set with leda door frame, wooden or steel

CONSTRUCTION

- dedicated HALSPAN filling respectively 44 mm thick for type EI30 and 54 mm for type EI60
- total thickness of door leaf respectively 50 mm for EI30 and 60 mm for EI60
- conifer frame
- fire resistant and intumescent expanding seal
- automatic door seal

FINISHING

- door leaf edge made in STANDARD technology

HARDWARE

- three hinges, $\varnothing 18$ regulated in three planes
- door lock cylinder
- door closer (add. charged)

FRAMES

- wooden fire protection fixed frame
- fire resistant seal
- electric strike or strike plate with regulation
- metal adjustable square frame of large size or welded and painted in RAL 9010, 9016, 8003, 8017, 7016, 7047, 1001

ADDITIONAL CHARGES

fire resistant door closer.

fire resistant ventilation grill

ventilation grill

SAFE INOX knob lub STANDARD INOX knob, page 109

lower lock plate

cylinder 30/40 (EI30) or 30/50 (EI60)

fire resistant upper lock

fire resistant peep-hole

GREKO



WALNUT GREKO



GOLDEN OAK GREKO



SANREMO GREKO



OAK GREKO

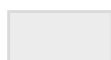

WHITE GREKO¹⁾



SONOMA GREKO



GREY OAK GREKO



MEDIUM OAK GREKO



WHITE PINE GREKO



BRIGHT WHITE GREKO¹⁾



ELM GREKO

FINISH



WALNUT



ACACIA



BRIGHT ACACIA

CPL



OAK ST CPL



GREY OAK ST CPL



VENGE ST CPL



GREY PINE ST CPL²⁾

PREMIUM



WALNUT PREMIUM



GREY MAPLE PREMIUM



OAK PREMIUM

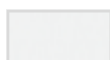

WHITE BARK PREMIUM

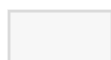

WHITE PREMIUM¹⁾



MODRZEW POPRZECZNY PREMIUM



GRAPHITE ASH PREMIUM



CONCRETE PREMIUM

¹⁾ white foil imitating painting surface

²⁾ available from 1st April 2019



WOODEN FRAME

LEDA EI30, EI60

FIXED WOODEN FRAME TO LEDA EI30 AND EI60

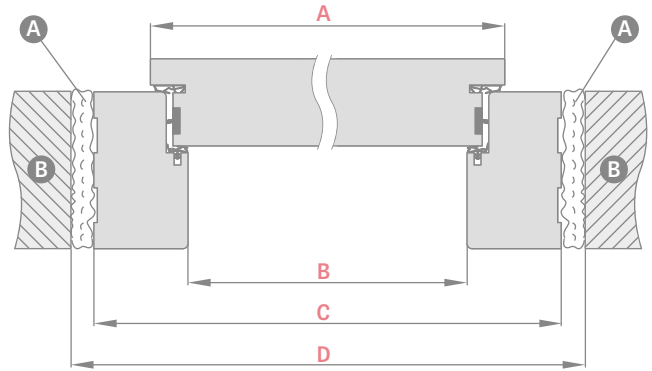
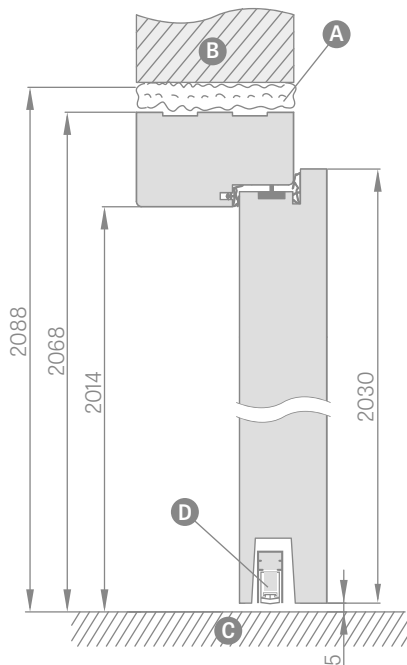

Width of door leaf	A	B	C	D
„80”	860	817	925	955
„90”	960	917	1025	1055
„100”	1060	1017	1125	1155

GENERAL INFORMATION

Wooden fire protection frame used for LEDA EI30 and LEDA EI60 is made in HALSPAN technology

CONSTRUCTION

Fixed frame is made of conifer ply in door leaf colour and has fire protection seal

HARDWARE

- three hinges, $\varnothing 18$ regulated in three planes
- electric strike or strike plate with regulation

ADDITIONAL CHARGES

fire resistant electric strike

for EI30 from 100 to 460 and
for EI60 from 120 to 480 every 20 mm

double doors

- **A** – fire resistant mounting foam
- **B** – wall **C** – floor **D** – automatic door seal

ELECTRIC STRIKE



Track door closer



DOOR CLOSER



INTERSECTION OF WALL-MOUNTED FIRE RESISTANT DOOR FRAME

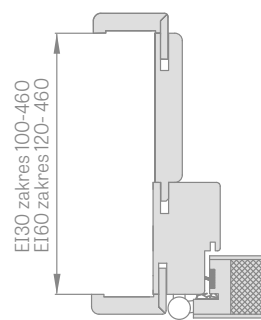

INTERSECTION OF FIXED FIRE RESISTANT DOOR FRAME

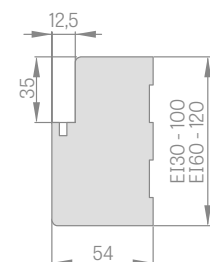



METAL DOOR FRAMES

LEDA EI30, EI60

GENERAL INFORMATION

Wooden fire protection frame used for LEDA EI30 and LEDA EI60 is made in HALSPAN technology

CONSTRUCTION

Fixed frame is made of black steel 1.5 mm thick painted RAL, corner welded and with fire protection seal and enforcement for self-lock in standard.

HARDWARE

- four hinges regulated in two planes
- strike plate or electric strike (add. charged)

METAL SQUARE FRAME, LARGE SIZE, FIRE PROTECTION

welded and painted in RAL 9010, 9016, 8003, 8017, 7016, 7047, 1001

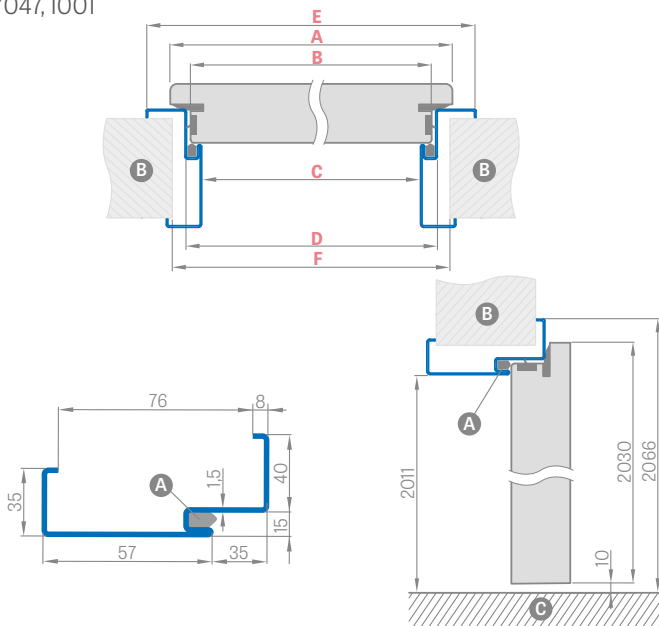

Width of door leaf	A	B	C	D	E	F
„80”	860	834	813	843	923	895
„90”	960	934	913	943	1023	995
„100”	1060	1034	1013	1043	1123	1095

LAUNCHING EDGE FRAME

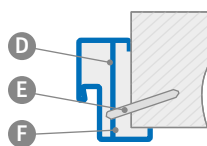

- A** - rubber seal
- B** - wall
- C** - floor
- D** - assembly anchor
- E** - expansion bolt
- F** - filler

ADDITIONAL CHARGES

fire resistant electric strike

adjustable frame „100”

fixed frame „100”

finishing with galvanised steel

double doors frame

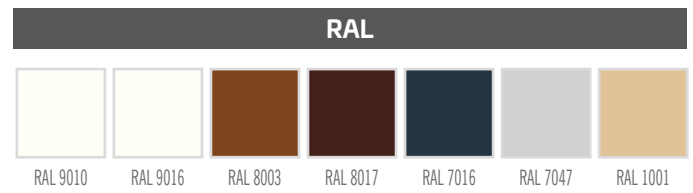

FIRE PROTECTION METAL ADJUSTABLE FRAME CASING TYPE

welded and painted in RAL9010, 9016, 8003, 8017, 7016, 7047, 1001

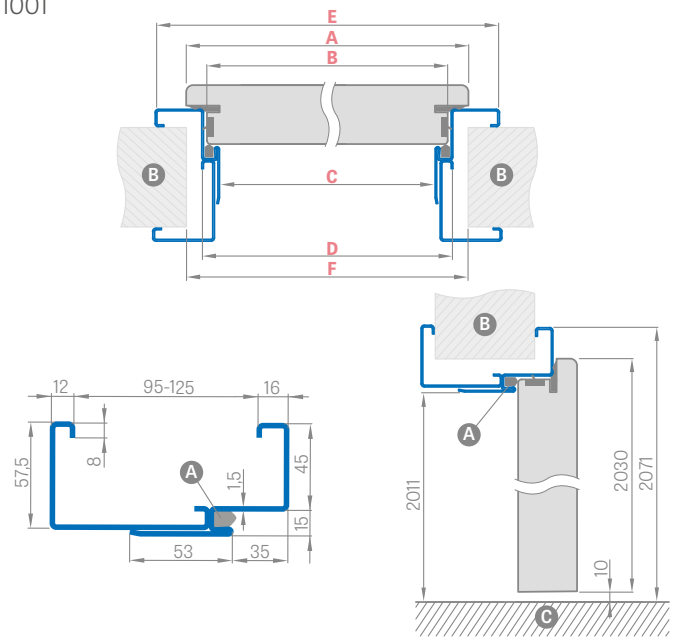

Width of door leaf	A	B	C	D	E	F
„80”	860	834	813	843	933	910
„90”	960	934	913	943	1033	1010
„100”	1060	1034	1013	1043	1133	1110

Adjustment range min.-max (mm)
95-125
125-155
155-185
185-215
215-245
245-275
275-305

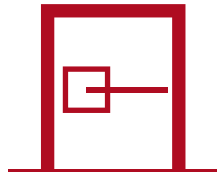

HARDWARE

DOOR KNOBS TO BOARD and STILE DOORS

The knobs must not be applied with board doors together with frame casing, see page 142

METAL-BUD LUNA PREMIUM door knobs chrome gloss, brushed chrome matt, brass gloss, black matt

Metal-Bud

NEW



chrome gloss



brushed chrome matt



brass gloss



black matt



key lock plate
cylinder lock plate
bathroom lock plate

DOOR KNOB CLASS
PREMIUM

METAL-BUD CUBE door knobs chrome gloss, brushed chrome matt, black matt



chrome gloss



brushed chrome matt



black matt



key lock plate
cylinder lock plate
bathroom lock plate

DOOR KNOB CLASS
PREMIUM

DOOR KNOBS TO BOARD and STILE DOORS

The knobs must not be applied with board doors together with frame casing, see page 142

METAL-BUD CUBE PREMIUM door knobs chrome gloss, brushed chrome matt, black matt

Metal-Bud

NEW



chrome gloss



brushed chrome matt



black matt

DOOR KNOB CLASS
PREMIUM



key lock plate
cylinder lock plate
bathroom lock plate

METAL-BUD TREND door knobs nickel satin, graphite/chrome, chrome gloss



nickel satin



graphite/chrome



chrome gloss

LOCK PLATE nickel satin, graphite/chrome, chrome gloss to **DUO, TREND** models



key lock plate
cylinder lock plate
bathroom lock plate

METAL-BUD SIGMA door knobs black matt, white matt

AVAILABLE ONLY AT ERKADO



SIGMA
black matt



SIGMA
white matt



key lock plate, cylinder lock plate, bathroom lock plate

DOOR KNOBS TO BOARD and STILE DOORS

The knobs must not be applied with board doors together with frame casing, see page 142

structural METAL-BUD DECO door knob chrome gloss, nickel satin

Metal-Bud



MEDIUM OAK GREKO decor



BLACK decor



BRIGHT WHITE GREKO decor



SONOMA GREKO decor



WALNUT GREKO decor



OAK GREKO decor



SANREMO GREKO decor

METAL-BUD BOLZANO door knob chrome gloss, nickel satin, graphite/chrome, white matt, black matt



chrome gloss



graphite/chrome



nickel satin



white matt

NEW



black matt

NEW

METAL-BUD MILANO door knob chrome gloss, nickel satin, graphite/chrome



chrome gloss



graphite/chrome



nickel satin

LOCK PLATE chrome gloss, nickel satin, graphite/chrome, white matt, black matt to **DECO, BOLZANO, MILANO** models



key lock plate
cylinder lock plate
bathroom lock plate

DOOR KNOBS TO BOARD and STILE DOORS

The knobs must not be applied with board doors together with frame casing, see page 142

METAL-BUD ERKADO knobs stainless steel

Metal-Bud



NEW

SAPPHIRE INOX knob



METRO INOX knob



NEW

PROXIMA INOX SQUARE knob



FUTURA INOX knob



PREMIUM INOX knob



SYSTEM INOX knob



cylinder lock plate



key lock plate



bathroom lock plate



STANDARD INOX knob



SAFE INOX knob



NEW

ROMA INOX knob



cylinder lock plate



key lock plate



bathroom lock plate

METAL-BUD ERKADO knob black matt



FUTURA black knob



cylinder lock plate



key lock plate



bathroom lock plate

DOOR KNOBS TO BOARD and STILE DOORS

The knobs must not be applied with board doors together with frame casing, see page 142

METAL-BUD SYRIUSZ knobs white, black

Metal-Bud



NEW

SYRIUSZ white knob



cylinder lock plate



key lock plate



bathroom lock plate



NEW

SYRIUSZ black knob



cylinder lock plate



key lock plate



bathroom lock plate

TUPAI 2275 Q knobs brushed chrome, chrome gloss, black

TUPAI

DOOR KNOB CLASS
PREMIUM



chrome gloss



brushed chrome



black



key lock plate



cylinder lock plate

bathroom lock plate



TUPAI 2275 RT knobs chrome gloss, brushed chrome, black

DOOR KNOB CLASS
PREMIUM



chrome gloss



brushed chrome



black



key lock plate

cylinder lock plate

bathroom lock plate



DOOR KNOBS TO BOARD and STILE DOORS

The knobs must not be applied with board doors together with frame casing, see page 142

GAMET knobs chrome gloss, brushed nickel, antique brass



klamka MISTICO
chrome gloss



klamka MISTICO
brushed nickel



key lock plate, cylinder lock plate, bathroom lock plate



klamka ERBA
brushed nickel



klamka ERBA
antique brass



key lock plate, cylinder lock plate, bathroom lock plate



klamka CASCADA
brushed nickel



klamka CASCADA
antique brass



key lock plate, cylinder lock plate, bathroom lock plate

HOPPE DUBLIN knobs



F1 natural aluminium



F94 satin chrome



F249 chrome gloss



DOOR KNOBS TO BOARD and STILE DOORS WITH LONG LOCK PLATE

The knobs must not be applied to board doors together with frame casing, see page 142 (EXCLUDING BLANKA knob). Door knobs with long lock plate are not applied to non-rebated doors (distance, page 118)

METAL-BUD ASTRA i BLANKA knobs nickel, patina, chrome/satin
 – BLANKA knob is recommended to board doors with frame casing, page 142

Metal-Bud



ASTRA nikiel, patina knob
key lock plate



NEW

BLANKA chrome/satin, patina knob
key lock plate



NEW



ASTRA nickel knob and BLANKA chrome/satin, patina
bathroom lock plate



ASTRA nickel knob and BLANKA chrome/satin, patina
cylinder lock plate



ASTRA nickel knob and BLANKA chrome/satin, patina
lock plate, economy lock

METAL-BUD TOPAZ INOX knob, long lock plate stainless steel



TOPAZ INOX knob
key lock plate



TOPAZ INOX knob
bathroom lock plate



TOPAZ INOX knob
cylinder lock plate



TOPAZ INOX knob
lock plate, economy
lock

KNOBS TO HERSE SET, HERSE LUX SET, HERSE MAX SET

METAL-BUD ERKADO BONN and ESSEN knobs



BONN knob and plate



BONN knob and plate



BONN knob and plate



ESSEN knob and plate



patina

CYLINDERS



cylinder
nickel satine colour



cylinder with knob
nickel satine colour

CYLINDER	CYLINDER WITH KNOB
size	size
26/36	G30/40
30/30	G40/30
30/45	G30/50
30/50	G50/30
	30/45G
	30G/45

Cylinders 30/45 + 30G/45, one-key system, doors opening outside

Cylinders 30/45 + 30G/45, one-key system, doors opening inside



TECHNICAL INFORMATION



DIRECTIONS OF OPENING

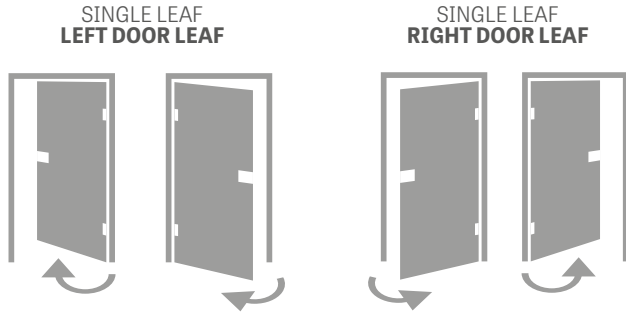

REBATED, NON-REBATED AND REVERSE DOOR LEAFS

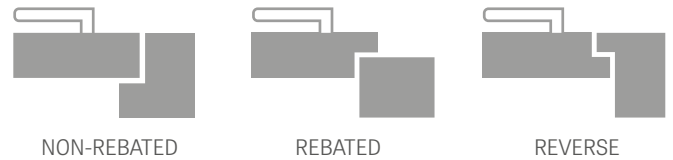

DOUBLE DOORS

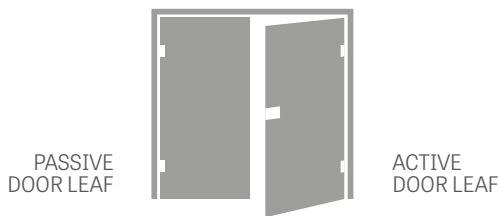

FRAME CORNER CONNECTION



PROPER SELECTION OF CYLINDER

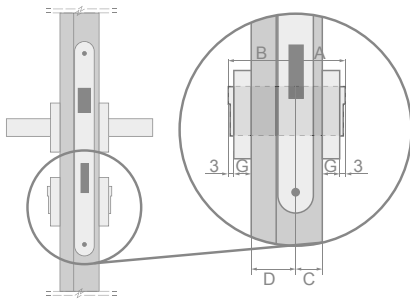

Exemplary calculation of the proper size of cylinder for board and stile door leaves (40 mm) with the thickness of face $G = 7$ mm

$$A/B = (C+G+3) / (D+G+3)$$

$$A/B = (15+7+3) / (25+7+3)$$

$$A/B = 25/35$$

Door type	Door leaf thickness	Lock proportions (c/d)	Recommended cylinder size (a/b)*
board, stile (rebated)	40 mm	15/25	26/36
board, stile (non-rebated)	40 mm	20/20	30/30
HERSE	46 mm	15/31	30/45
LEDA EI 30	50 mm	19/31	30/40
LEDA EI 60	60 mm	19/41	30/50

* Recommended cylinder size for the lock plate 7 mm thick and distance 2-4 mm

PROPER CALCULATION OF DOOR SET

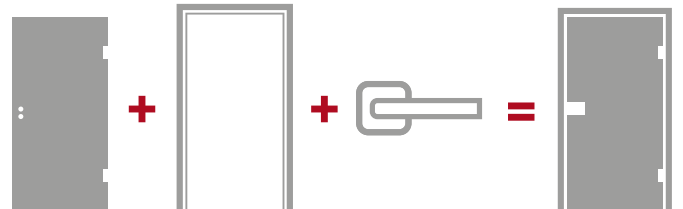

AVAILABLE SOLUTIONS (page 119-130)

- single on-wall sliding system



- double on-wall sliding system



- single in-wall sliding system



- double doors in-wall sliding systems

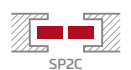

- supplementary system ZN1



- supplementary system ZN2



- double doors



TYPES OF DECORS

FINISH

Finish material is re-impregnated foil, is printed and protected with the lacquer and coatings of desired parameters. The application of improved finishing layers results in the increase of better surface

GREKO

Pre-impregnated foil, is printed and protected with the lacquer and coatings of desired parameters. The application of improved finishing layers results in the increase of better surface resistance and flexibility of the product itself. The presence of silicone makes the foils much more resistant to water.

GREKO decor is manufactured on the basis of Japanese base coat of high density. The base is not resined. Thanks to lack of varnish, the foil becomes ecological and is safe for the health and the environment, not only during the production process but also during exploitation and recycling. The foil does not contain formaldehyde and the harmful substances.

What makes GREKO foil so unique is the unusual, stunning design. High quality of the surface goes together with the 3D effect of natural wood. These decors bring to mind the natural structure of wood

PREMIUM

The product on the basis of polypropylene (PP) i.e. the material of high resistance to scratches and friction, providing equally great visual values. This material gives a door leaf noble looks and ensures an individual profile. At the same, it faithfully reflects the structure of natural wood.

The PREMIUM material convinces both with its design and functionality. It is equally resistant to friction, fire resistant and durable.

All products from PREMIUM line guarantee long-term usage including even hard exploitation conditions without any inconveniences..

CPL

CPL laminate is composed of decorative layer impregnated in resin and the base layer providing flexibility. After laminating process, upper surface (resin) becomes hardened and it results in being impressively strong and resistant to friction and scratches. Also, it is characterized by high intolerance to high temperature and UV radiation.

Applying CPL laminate allows to exploit doors in so called tough spaces [being exposed to extreme conditions, humidity and over regular exploitation. The laminate is 0,15 mm thick.

TYPES OF EDGE FINISHING

SOFT EDGE

A door leaf made with soft edge finishing is free of sharp edges and that makes it look aesthetic and modern. The applied decors are more resistant to scratches and this improves general condition of the door leaf and its exploitation.

The foils applied to SOFT edge is connected in two spots shown in the picture below (not applicable for the bright white greko decor as the foil is connected on the rebate).



STANDARD EDGE

The flat surface is covered with CPL ST 0,15 mm thick, polypropylene PREMIUM foil or GREKO FINISH foil.

A door leaf with this type of edge finishing is of straight edge. The surface material joins with the rebate material on the very edge of the rebate. This is illustrated by the picture below. The exact manner of joining the material is applied to non-rebated door leaves, in general, and for sliding systems..

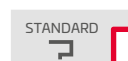

SOFT PCV FINISHING

SOFT PCV is based on high pressure application of the PCV material 0.7 mm thick on the flat or milled surface, together with the rebate. The joining of the material is in the invisible place. PCV material applied on the door leaf results in creating a unique and hard surface resistant to scratches, extreme temperature, humidity and detergents.

SOFT PCV technology is used in production of interior entrance doors from HERSE collection.



STILE DOOR LEAF

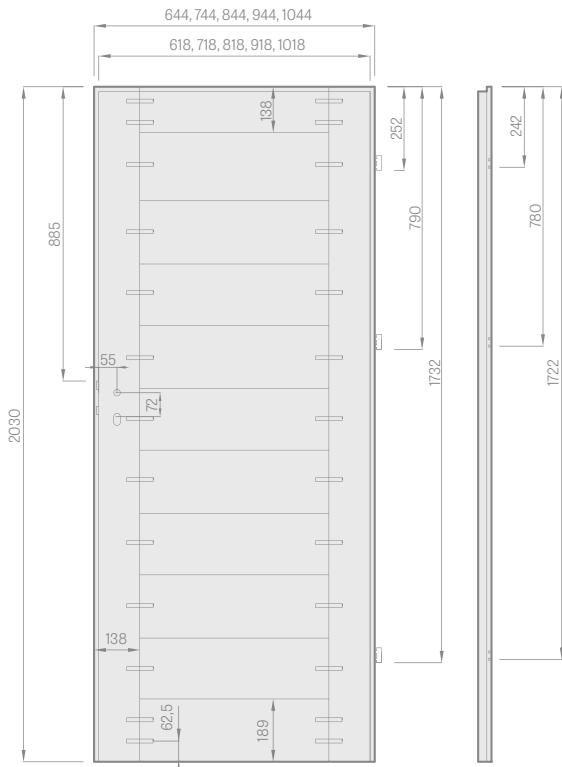

rebated door leaf

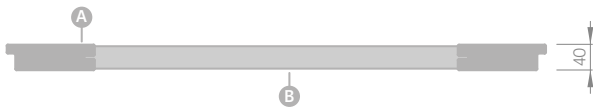

- A** MDF or wooden rails in PREMIUM decors
- B** MDF bars



Solid rail 22 mm thick



Esthetic profiled non-rail glazing



MDF rail for GREKO foils



Wooden rail for PREMIUM and CPL foil
- core made of layer plywood

BOARD DOOR LEAF

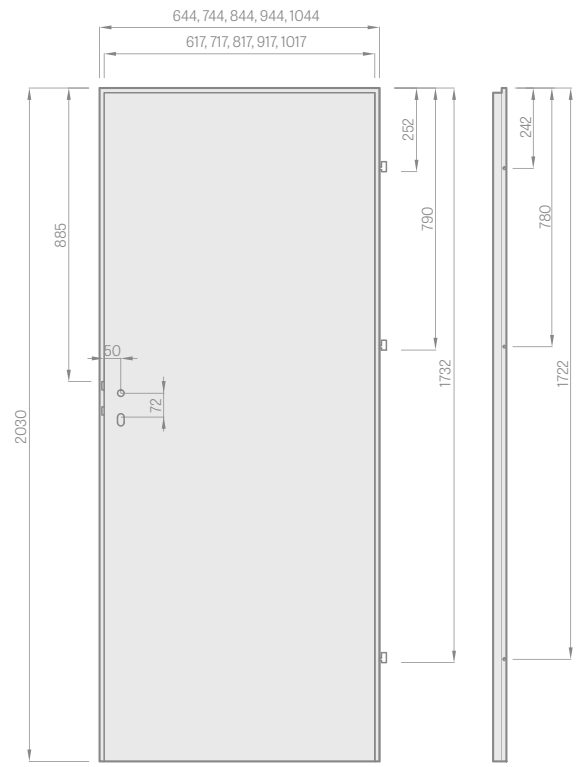

rebated door leaf

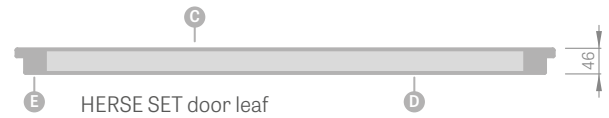

HERSE SET door leaf

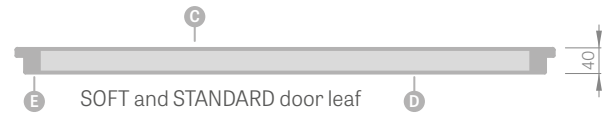

SOFT and STANDARD door leaf

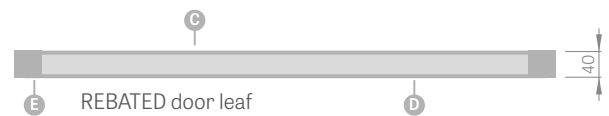

REBATED door leaf

- A** MDF board; **C** HDF board; **D** filling;
- E** MDF or wooden rails for HERSE SET and UNO PREMIUM

TYPES OF FILLINGS

honeycomb core



full plate board



Honeycomb core and full plate board fillings come only with board doors.
Erkado applies mandatorily third hinge with full plate board.

GRAF GLASS PANEL

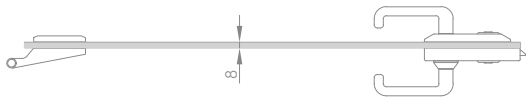
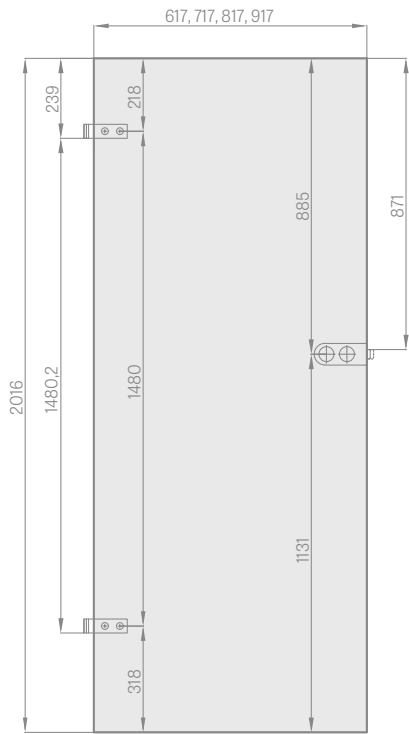

LEDA DOOR LEAF

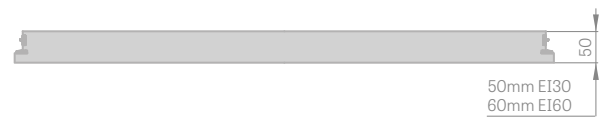
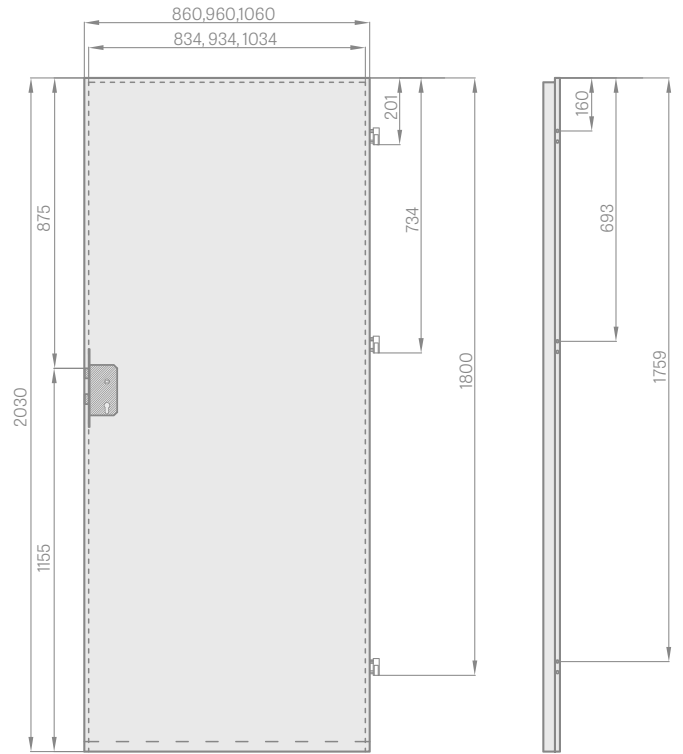

BATHROOM LOCK

exterior side (Z)

interior side (W)

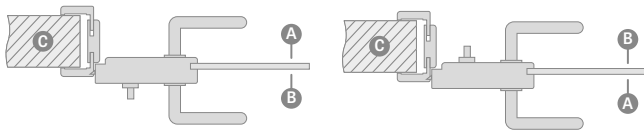

A hall; B bathroom; C wall

Bathroom lock – when ordering bathroom lock, the following should be selected:

exterior lock – when blocking is to be fixed on the exterior side of the door (Z)

or

interior lock – when blocking is to be fixed on the interior side of the door (W).

Attention: bathroom locks are either left or right

STANDARD GLAZING OBVERSE

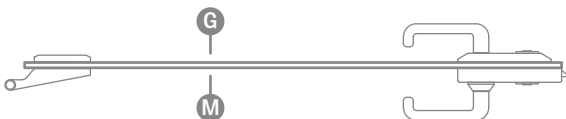

GLAZING ON DEMAND REVERSE:

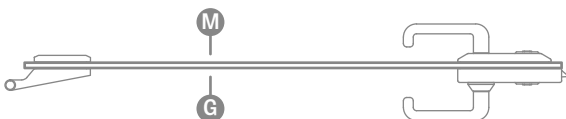

G smooth side; M matt decorated side



Dedicated HALSPAN filling
44 mm [EI30] /
54 mm [EI60]



Fire resistant and
intumescent expanding seal



Automatic door seal



Three practical hinges with
3D regulation



Fixed frame

METAL HINGE CASINGS



brushed nickel, patina, chrome polysk, brass gloss, white matt i black matt

Casing dimensions:

- internal diameter 16 mm for HERSE SET
- internal diameter 15 mm for board and STILE doors.
- length 47 mm

Ventilation cut and ventilation sleeves

Ventilation cut is not available for non-rebated door leaves to on-wall and in-wall sliding systems.

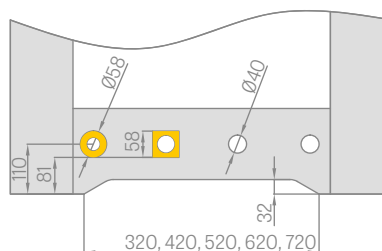

VENTILATION



Plastic ventilation sleeves for FINISH decors



Plastic woodgrain ventilation sleeves to STILE doors in GREKO, PREMIUM and CPL decors



Square and round metal ventilation sleeves



Ventilation grills

TRIMMING DOOR LEAFS

It is possible to trim the door leaf in Polish Norm, individually, up to max 50 mm or 80 mm in HERSE SET doors (if not already trimmed in the factory) or in board doors leaves only if an additional bottom bar was fixed.

(ATTENTION: the following must not be trimmed: FRAGI, double doors, LEDA, non-rebated door leaves to sliding systems, GRAF glass doors and any STILE door leaf in Czech Norm.

GLAZING IN STANDARD - OBLVERSE

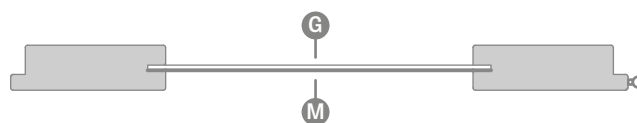

GLAZING ON DEMAND - REVERSE

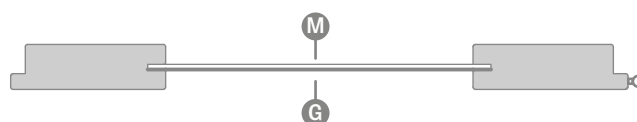

G smooth side; M matt decorated side

GLUED GLASS VSG 221, 331, 441 MILK GLASS

to STILE door leaves

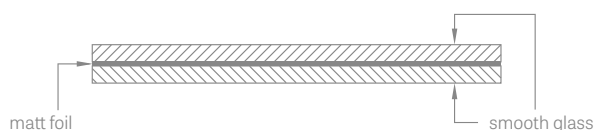

CLEANING KIT FOR REGENERATING AND MAINTAINING DOOR SURFACES BY OTTIMO



2 x 250 ml

ELECTRIC STRIKE

(available for fixed and adjustable frame to rebated door leaves, however not available for the GRAF glass frames)



Types of electric strikes:

- basic 12 V
- basic 24 V
- with switch-off 12 V
- with switch-off 24 V
- reverse 12 V
- reverse 24 V

BASIC WITH THE SWITCH - closed all the time, opens when voltage is on
- works as the basic one but has possibility to be switched off

REVERSE - supplying voltage causes closing, lack of voltage opening

FIXING FRAME TO NON-REBATED DOOR LEAFS

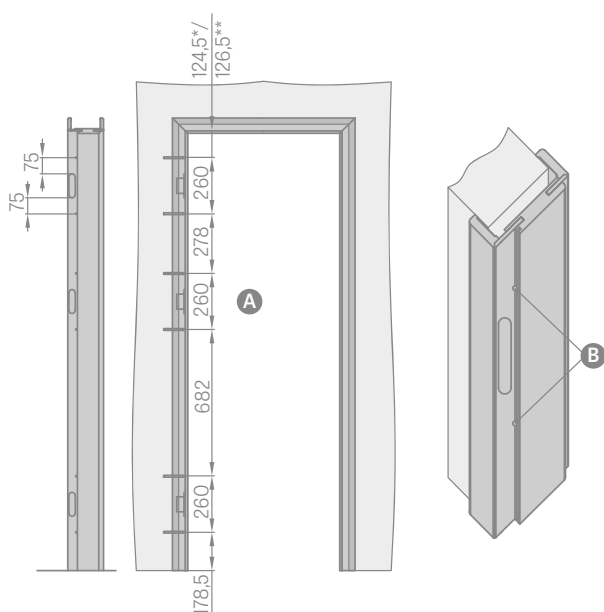

*Adj. cover list 6 cm / **Adj. cover list 8 cm

- A** Drill holes for metal screws min. 80 mm long x \varnothing 6 mm
- B** At assembly of frame, it is required to use mounting anchors together with mounting foam. The seal should cover the holes drilled underneath

MILLING IN HERSE DOOR LEAFS

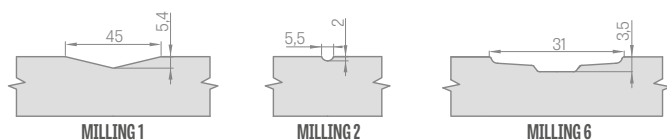

TYPE OF MILLING TO HERSE MAX			
HERSE MAX 1	HERSE MAX 2	HERSE MAX 3	HERSE MAX 6
MILLING 6	MILLING 6	MILLING 6	MILLING 6
HERSE MAX 7	HERSE MAX 13	HERSE MAX 14	HERSE MAX 22
MILLING 6	MILLING 1	MILLING 2	MILLING 2

HARDWARE

BOLT LOCKS

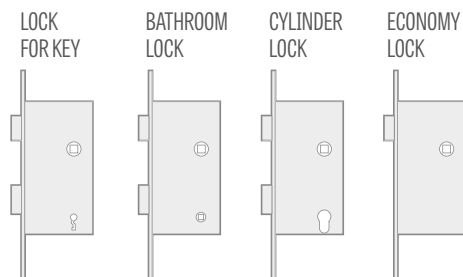

LOCK DISTANCES:

1. In rebated doors the distance of key, bathroom and cylinder lock plate is 72 mm.
2. In non-rebated and reverse doors the distance of magnetic lock plate is respectively:
 - key and bathroom distance 90 mm
 - cylinder distance 85 mm

HERSE SET DEFAULT ACCESSORIES

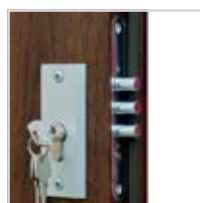

upper anti-burglary lock



door leaf 46 mm enforcement with massive iron profile

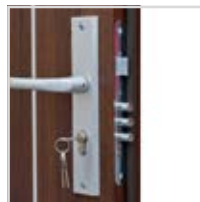

lower anti-burglary lock



anti-burglary contact bolts



main frame plate with regulation



two pintle hinge \varnothing 16 with 3D regulation



fixed frame



threshold of hard wood (not painted)

NON-REBATED HARDWARE



hidden hinge



magnetic lock



magnetic lock plate with regulation





door leaf faced with frame



SLIDING SYSTEM

ON-WALL

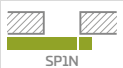
ON-WALL SLIDING SYSTEM:

SINGLE SP1Nz (with hook)	
SINGLE SP1Nb (without hook)	
DOUBLE SP2N	

Available configurations of on-wall sliding systems:

- aluminium rail with masking trim and borderer (only SP1Nz and SP1Nb)
- aluminium rail with masking trim and tunnel frame (only SP2N)
- aluminium rail with borderer and tunnel frame (only SP1Nz and SP1Nb)
- aluminium rail with masking trim and with borderer and tunnel frame (only SP1Nz and SP1Nb)

It is not possible to have ventilation cut in non-rebated door leaves to in-wall sliding system.

ADDITIONAL CHARGES

adjustable tunnel frame in the price of adjustable frame

hook lock with hardware
only to single system

oval holder or round holder in the following colours: chrome gloss, brushed chrome, brass gloss; a set of holders consists of two pieces

synch system

system that allows for opening and closing two non-rebate door leaves equally at the same time by using only one door leaf.
only to SP2N

door-closer

automatic system of closing the door leaf in its ending phase.
available only to SP1Nz and SP1Nb

ROUND AND OVAL METAL HOLDERS

chrome gloss, brushed chrome, brass gloss, black matt



HOOK LOCK FOR KEY

chrome gloss,
brushed chrome,
brass gloss
black matt

Key comes only in
silver colour

Hook lock set includes two silver
holders





ON-WALL SLIDING SYSTEM

WITH FRAME

SP1Nz or SP1Nb (left; obverse glazing)

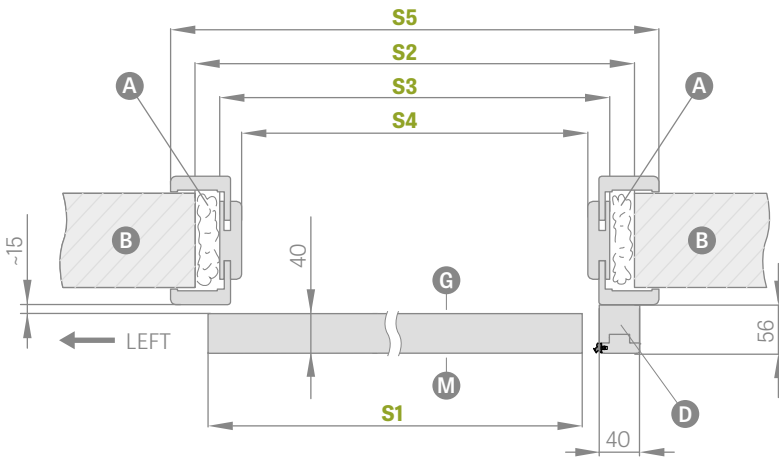

SP2N (obverse glazing)

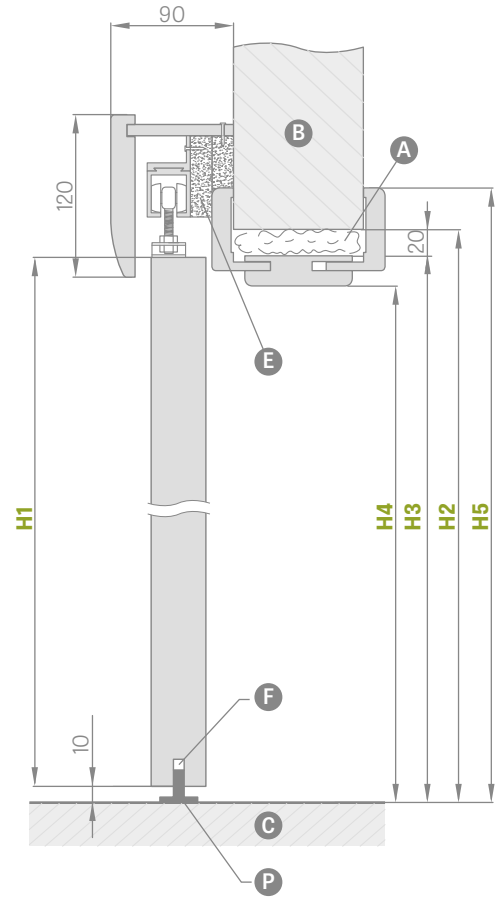
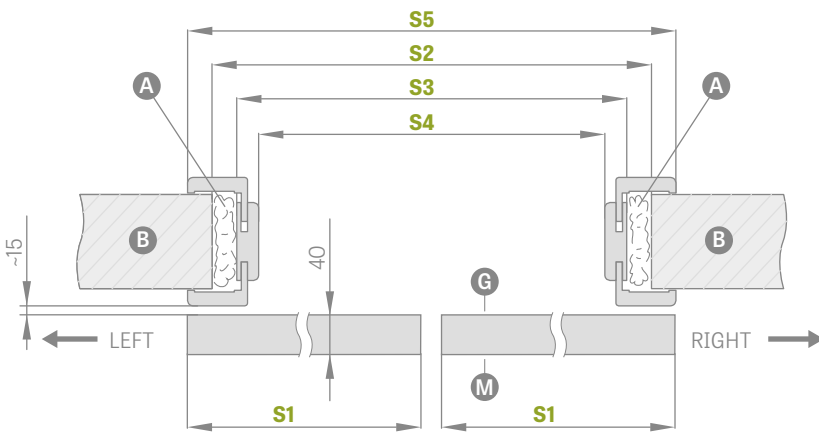

- A** – mounting foam
- B** – wall
- C** – floor
- D** – borderer
- E** – distance profiles
- F** – milling for the rail
- G** – glass smooth side
- M** – glass matt side
- P** – flooring rail

SLIDING SYSTEM WITH FRAME

SINGLE DOOR LEAF SP1N

DOUBLE DOOR LEAFS SP2N

		,60"	,70"	,80"	,90"	,100"	,60" x 2	,70" x 2	,80" x 2	,90" x 2	,100" x 2
S1	Width of door leaf	644	744	844	944	1044	1288	1488	1688	1888	2088
S2	Width of hole in wall	688	788	888	988	1088	1288	1488	1688	1888	2088
S3	Frame width	648	748	848	948	1048	1248	1448	1648	1848	2048
S4	Door frame clear width	604	704	804	904	1004	1204	1404	1604	1804	2004
S5	Frame covering width adj. cover list 6 cm/adj. cover list 8cm	746/ 786	846/ 886	946/ 986	1046/ 1086	1146/ 1186	1346/ 1386	1546/ 1586	1746/ 1786	1946/ 1986	2146/ none
H1	Height of door leaf	2030	2030	2030	2030	2030	2030	2030	2030	2030	2030
H2	Height of hole in wall	2060	2060	2060	2060	2060	2060	2060	2060	2060	2060
H3	Frame height	2040	2040	2040	2040	2040	2040	2040	2040	2040	2040
H4	Door frame clear height	2018	2018	2018	2018	2018	2018	2018	2018	2018	2018
H5	Door frame clear height adj. cover list 6 cm/adj. cover list 8cm	2089/ 2109	2089/ 2109	2089/ 2109	2089/ 2109	2089/ 2109	2089/ 2109	2089/ 2109	2089/ 2109	2089/ 2109	2089/ -



ON-WALL SLIDING SYSTEM

WITHOUT THE FRAME

SP1Nz or SP1Nb (left; reverse glazing)

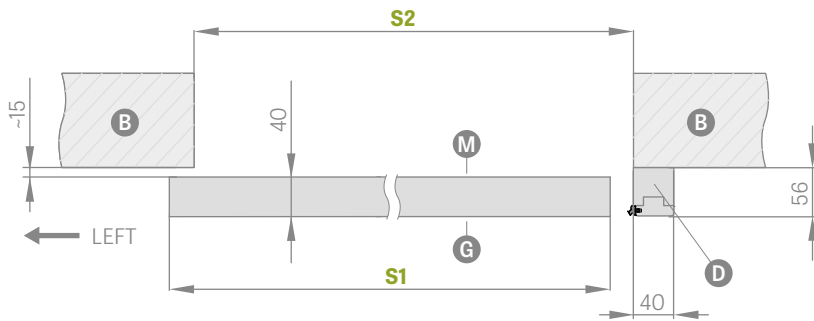

SP2N (reverse glazing)

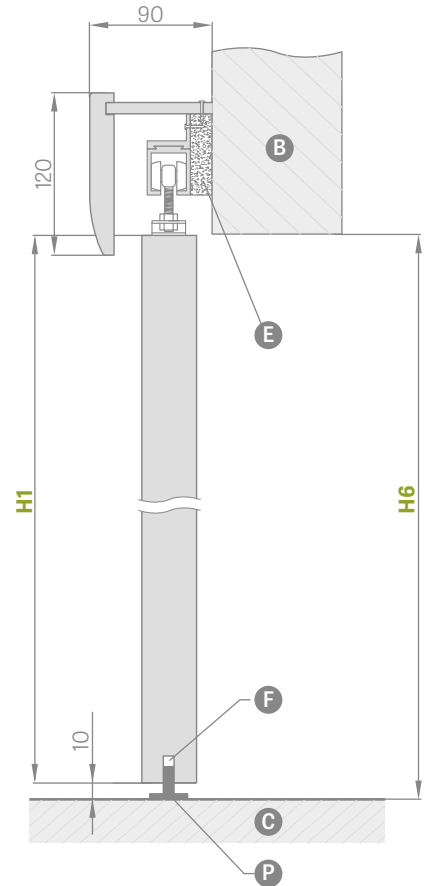
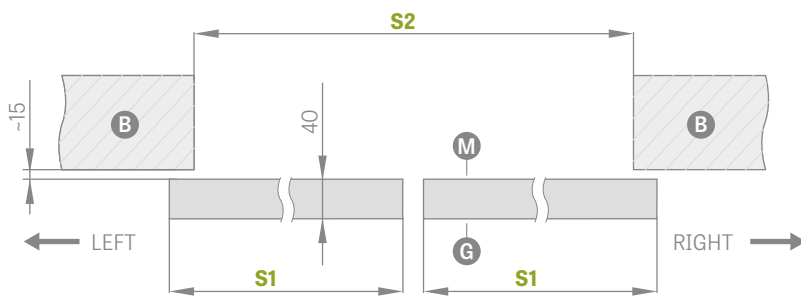

- B**— wall
- D**— borderer
- F**— milling for the rail
- P**— flooring rail
- C**— floor
- E**— distance profiles
- G**— glass smooth side
- M**— glass matt side

SLIDING SYSTEM WITHOUT FRAME

		SINGLE DOOR LEAF					DOUBLE DOOR LEAF				
		„60“	„70“	„80“	„90“	„100“	„60“ x 2	„70“ x 2	„80“ x 2	„90“ x 2	„100“ x 2
S1	Width of door leaf	644	744	844	944	1044	1288	1488	1688	1888	2088
S2	Width of hole in wall	602	702	802	902	1002	1202	1402	1602	1802	2002
H1	Height of door leaf	2030	2030	2030	2030	2030	2030	2030	2030	2030	2030
H6	Height of hole in wall	2020	2020	2020	2020	2020	2020	2020	2020	2020	2020



ON-WALL SLIDING SYSTEM

LOFT type



ALTAMURA 1
decor OAK ST CPL, round holder

Sliding system LOFT type is available only in black colour and comes in a set with type full plain door leaf LOFT type. In standard LOFT type door leaf has honeycomb core stabilising filling or solid board (add. charged).

Door leaf is of STANDARD edge.

System is designed to already prepared hole and the tunnel is not applicable.

Full set includes: LOFT sliding system + LOFT door leaf + holder

sliding system LOFT type

oval or round holder, black matt

filling with solid board

metal hinge casings, round and square (4 pcs.); finishing: black matt

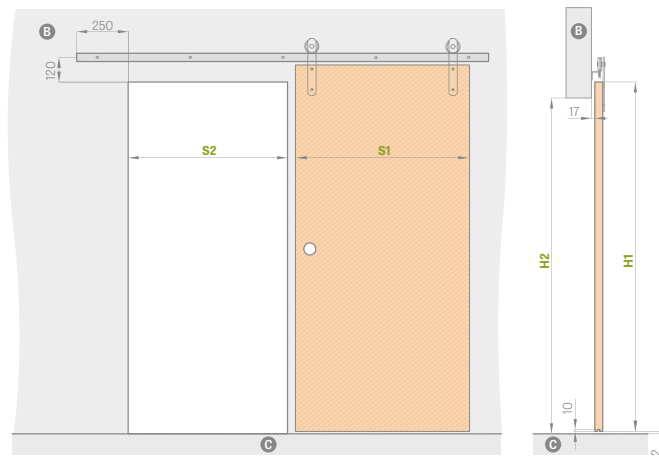

	,60"	,70"	,80"	,90"	,100"
S1 Width of door leaf	644	744	844	944	1044
S2 Width of hole in wall	574	674	774	874	974
H1 Height of door leaf	2150	2150	2150	2150	2150
H2 Height of wall hole	2082	2082	2082	2082	2082

B— wall **C**— floor



HOLDERS
ROUND and OVAL
black matt



LENGTH OF TRACKING RAIL:
- 200 cm to door leaf 60, 70, 80
- 250 cm to door leaf 90, 100

¹⁾ white foil imitating painting surface, ²⁾ available from 1st April 2019



ON-WALL SLIDING SYSTEM

MAGIC type



UNO PREMIUM
decor OAK PREMIUM, oval holder

MAGIC type on-wall sliding system comes only in a set with MAGIC type full plain door leaf. In standard MAGIC type door leaf has honeycomb core stabilising filling or solid board (add. charged). Door leaf is of STANDARD edge. System is designed to already prepared hole and the tunnel is not applicable.
Full set includes: MAGIC sliding system + MAGIC door leaf + holder

MAGIC sliding system

oval or round holder

filling with solid board

metal hinge casings, round and square (4 pcs.); finishing: chrome gloss, brushed chrome, black matt

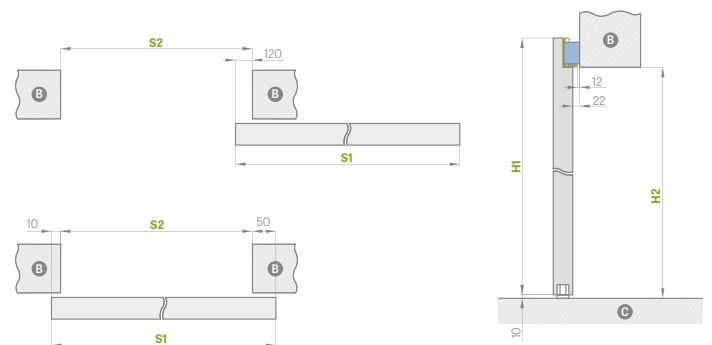

MAGIC ON-WALL SLIDING SYSTEM						
		„60”	„70”	„80”	„90”	„100”
S1	Width of door leaf	644	744	844	944	1044
S2	Width of wall hole	584	684	784	984	1084
H1	Height of door leaf	2150	2150	2150	2150	2150
H2	Height of wall hole	2100	2100	2100	2100	2100



METAL ROUND AND OVAL HOLDERS

chrome gloss, brushed chrome, brass gloss, black matt



¹⁾ white foil imitating painting surface, ²⁾ available from 1st April 2019



ON-WALL SLIDING SYSTEM

GRAF GLASS DOORS

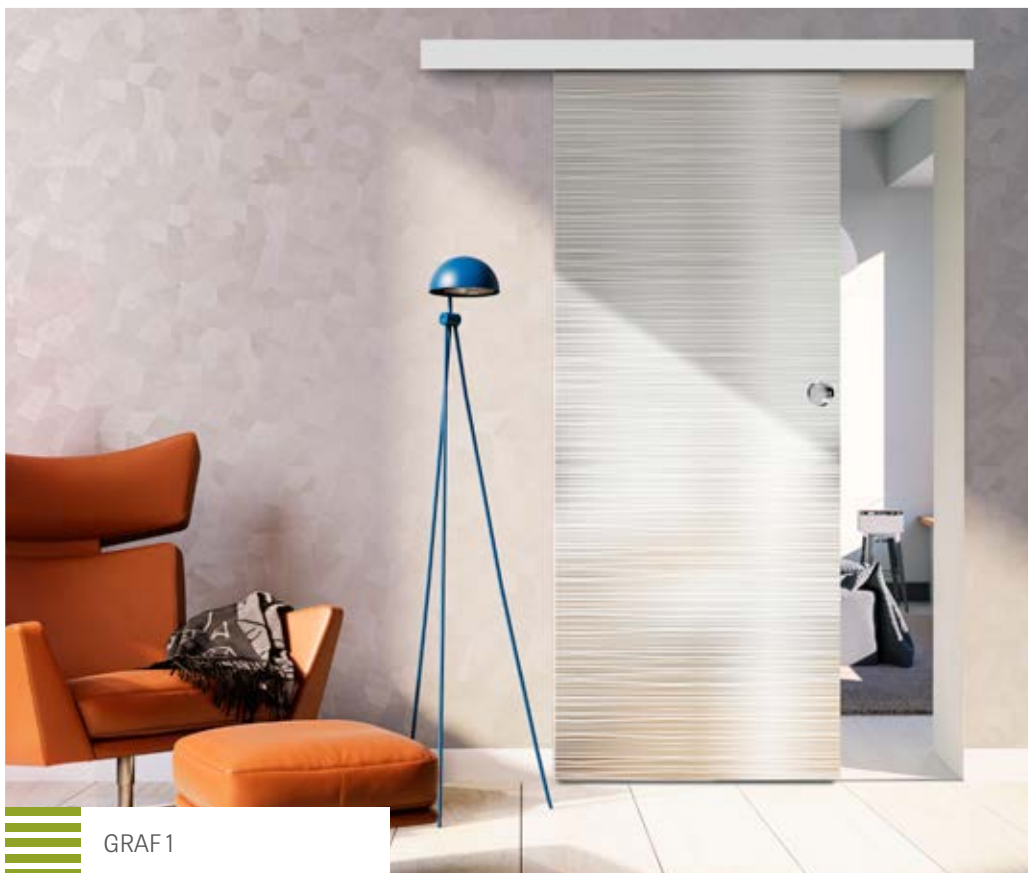

GRAF 1

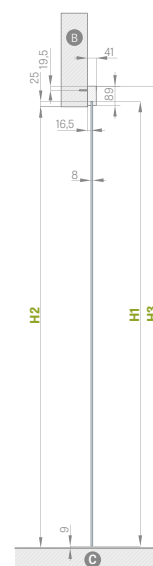

Sliding system to glass doors with anodised aluminium masking trim in silver colour.

This system is complete and is applied to already prepared hole as the tunnel is not available.

The system comprises all glass GRAF panels, page 56/57.

Full system consists of: sliding GRAF SYSTEM + glass GRAF panel + holder

sliding system of GLASS DOORS

round double-sided holder stainless steel

glass panel 90 wide

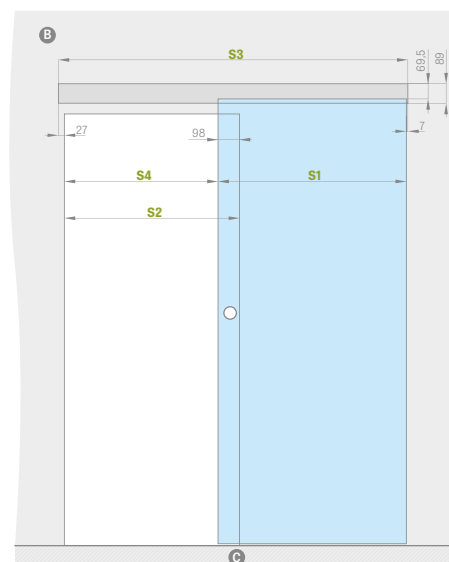

HOLDERS
stainless steel



		ON-WALL SLIDING SYSTEM GLASS DOORS			
		„60“	„70“	„80“	„90“
S1	Width of door leaf	662	762	862	962
S2	Width of wall hole	602	702	802	902
S3	Length of tracking rail	1200	1400	1600	1800
S4	Clear width	504	604	704	804
H1	Height of door leaf	2036			
H2	Height of wall hole	max. 2020			
H3	Total system height	2114			





B— wall **C**— floor

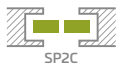

SLIDING SYSTEMS

IN-WALL

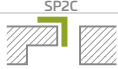
ERKADO offers the following types of in-wall sliding systems:

TUNNEL MOUNTING		
SP1C.100		single in-wall sliding system to panel 100 available only to STILE door leaves and models ALTAMURA 1, UNO PREMIUM and UNO LUX
SP2C.100		double in-wall sliding system to panel 100 available only to STILE door leaves and models ALTAMURA 1, UNO PREMIUM and UNO LUX
SP1C.125		single in-wall sliding system to panel 125
SP2C.125		double in-wall sliding system to panel 125
ZN1		single side supplementary basic wall mounting to system SP1C.100 or SP1C.125
ZN2		single side supplementary basic wall mounting to system SP2C.100 or SP2C.125

$$\text{PRICE OF SLIDING SYSTEM} = \text{PRICE OF DOOR LEAF} + \text{PRICE OF ALUMINIUM PANEL} + \text{PRICE OF TUNNEL FRAME}$$

Standard set of in-wall single/double sliding system includes the following elements:

- aluminium panel [LEON] SP1
- aluminium panel [LEON] SP2
- non-rebated door leaf/two non rebated door leaves
- tunnel frame construction

METAL ROUND AND OVAL HOLDERS

chrome gloss, brushed chrome, brass gloss, black matt



HOOK LOCK FOR KEY

chrome gloss,
brushed chrome,
brass gloss
black matt



Hook lock set includes
two silver holders

Key hook locks includes two selected holders

ADDITIONAL CHARGES

hook lock with hardware

available only to: SP1C.100, SP1C.125, SP1C.100.ZN i SP1C.125.ZN

oval or round holder

finishing: chrome gloss, brushed chrome, brass gloss
available only to SP1C.100, SP2C.100, SP1C.125, SP2C.125
set of holders consists of two pieces

thimble holder in colors: chrome gloss, brushed chrome, brass gloss

synch system

system that allows for opening and closing two non-rebate door leaves equally at the same time by using only one door leaf.
available only to: SP2C.100, SP2C.125

door-closer

automatic system of closing the door leaf in its ending phase.
Available only for SP1C.100, SP1C.125

Adjustment range of basic wall thickness min.max. (mm)
0-40; 40-60; 60-80;
80-100; 100-120; 120-140
140-160; 160-180; 180-200
200-220; 220-240
240-260; 260-280
280-300; 300-320
320-340; 340-360

- System is of one side of wall mounting to double doors ZN2 + 30 % to regular prices

		SINGLE AND DOUBLE IN-WALL SLIDING SYSTEMS									
		,60"	,70"	,80"	,90"	,100"	2 x ,60"	2 x ,70"	2 x ,80"	2 x ,90"	2 x ,100"
S1	Width of door leaf	644	744	844	944	1044	1288	1488	1688	1888	2088
S2	Door frame clear width	602	702	802	902	1002	1202	1402	1602	1802	2002
S3	Width of panel/hole in wall	1318	1518	1718	1918	2118	2538	2938	3338	3738	4138
S4	Frame covering width adj. cover list 6cm/adj. cover list 8cm	744 / 784	844 / 884	944 / 984	1044 / 1084	1144 / 1184	1344 / 1384	1544 / 1584	1744 / 1784	1944 / 1984	2144 / brak
S5	Panel hole width	655	755	855	955	1055	1255	1455	1655	1855	2055
H1	Height of door leaf	2030	2030	2030	2030	2030	2030	2030	2030	2030	2030
H2	Door frame clear height adj. cover list 6cm/adj. cover list 8cm	2092 / 2112	2092 / 2112	2092 / 2112	2092 / 2112	2092 / 2112	2092 / 2112	2092 / 2112	2092 / 2112	2092 / 2112	2092 / brak
H3	Height of PANEL/hole in wall	2115	2115	2115	2115	2115	2115	2115	2115	2115	2115
H4	Door frame clear height	2021	2021	2021	2021	2021	2021	2021	2021	2021	2021



In-wall sliding system



On-wall sliding system



SINGLE SLIDING SYSTEMS

IN-WALL



SP1C.100 (left; obverse glazing)

fixed range 100 mm

Panel thickness before gypsum board construction - 75 mm

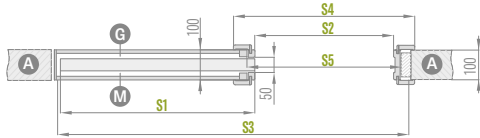

Only to models UNO PREMIUM, UNO LUX, ALTAMURA 1 and all STILE doors. System does not require and does not include anti dust brushes.

SP1C.125 (left; obverse glazing)

fixed range 125 mm

Panel thickness before gypsum board construction - 100 mm

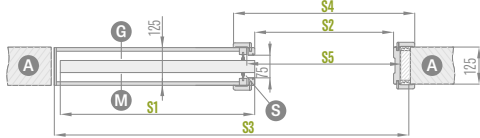

Applicable to all board door leaves that have glazing profile.
Not recommended to all STILE door leaves, UNO PREMIUM, UNO LUX and ALTAMURA 1

ZN1 single side basic wall mounting to SP1C.100 and SP1C.125

the range of basic wall mounting from 0-40; 40-60; ... 340-360

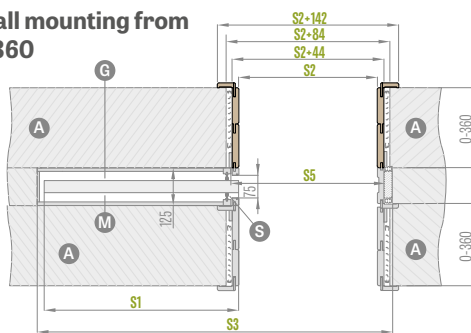

Basic wall mounting ZN2 on both sides ZN1 on both sides.

SP2C.125 (obverse glazing)

fixed range 125 mm

Panel thickness before gypsum board construction - 100 mm



Applicable to all board door leaves that have glazing profile.
Not recommended to all STILE door leaves, UNO PREMIUM, UNO LUX and ALTAMURA 1

SP2C.100 (obverse glazing)

fixed range 100 mm

Panel thickness before gypsum board construction - 75 mm



Applicable only to models UNO PREMIUM, UNO LUX, ALTAMURA 1 and all STILE door leaves.

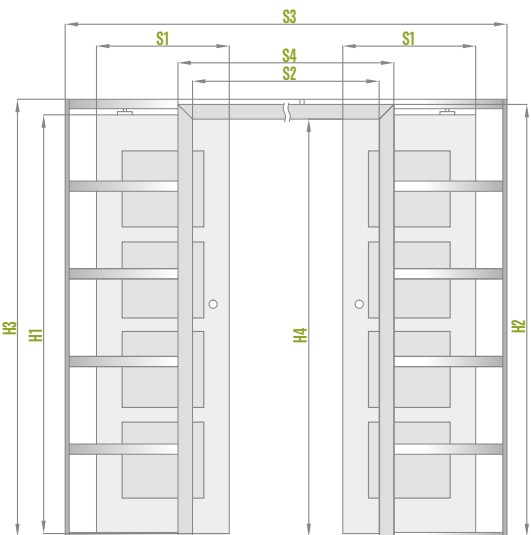
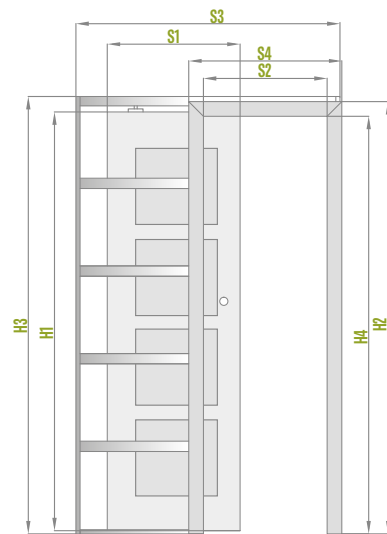

- A** - wall
- G** - glass smooth side
- M** - glass matt side
- I** - gypsum board
- S** - anti-dust brushes

ZN2 single side basic wall mounting to SP2C.100 and SP2C.125

the range of basic wall mounting from 0-40; 40-60; ... 340-360

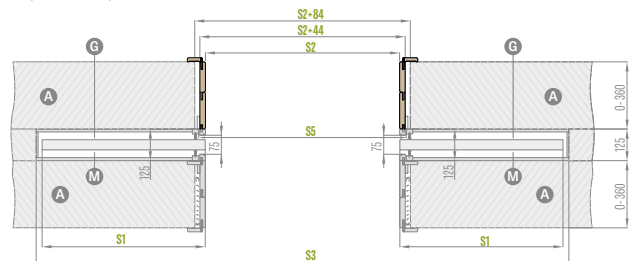

Basic wall mounting ZN2 on both sides



DOUBLE DOORS

REBATED, NON-REBATED

PRACTICAL INFORMATION:

DOUBLE DOORS



- Double doors have wood-based filling, additionally charged.
- DOUBLE DOORS are combined on the basis of available single door leaves in board and STILE technology and with corresponding features: decor, finishing (STANDARD, SOFT), glazing, etc.
- Passive door leaf is equipped with sash stops with door latch
- Passive door leaf below width 60 comes only as the full plain leaf – so called 'side leaf' (see the picture below)
- Side door leaves are made in board technology STANDARD edge and are available with honeycomb core filling or solid board (add. charged). Side door leaves are of vertical grain.
- Working and passive door leaves are equipped with door sashes
- Double doors in non-rebated technologies are available only with magnetic lock
- Non-rebated double doors come only with adjustable frame

AVAILABLE DOOR WIDTHS:

- board and stile double doors from 120 to 190 wide with the configuration of plain side leaf

60 + 30*	70 + 30*	80 + 30*	90 + 30*	100 + 30*
60 + 40*	70 + 40*	80 + 40*	90 + 40*	100 + 40*
60 + 50*	70 + 50*	80 + 50*	90 + 50*	100 + 50*

- * Side door leaf ('side leaf') is available only in STANDARD technology as full plain
- ** up to '180' for non-rebated door leaves

PRICE OF DOUBLE DOORS:

- Board and STILE doors: working door leaf **60 70 80 90 100** + passive door leaf **60 70 80 90***

Price of double door leaf with the sash = door leaf price x 2 + door sashes

- Board and STILE doors: working door leaf **60 70 80 90 100** + passive plain side leafs **30 40 50**

Price of double door leaf with 'side leaf' and the sash = door leaf price + side leaf with door sashes

- The price of double door fixed or adjustable frame + 30%

* does not concern non-rebated door leaves



DOUBLE DOORS

NON-REBATED

NON-REBATED DOUBLE DOORS
WITH ADJUSTABLE FRAME

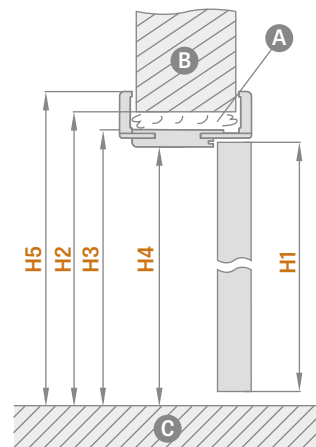
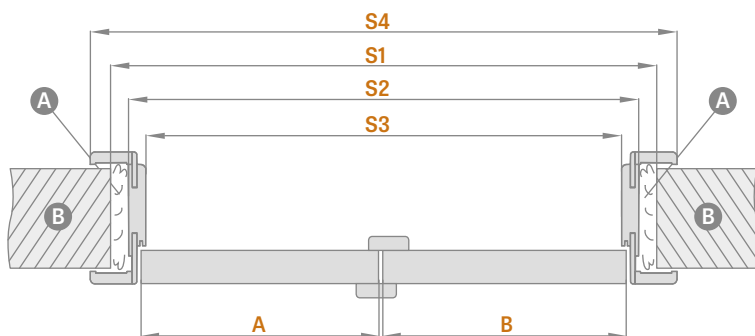

A—mounting foam B—wall C—floor

Adjustable frame		NON-REBATED DOUBLE DOORS									
		,90"	,100"	,110"	,120"	,130"	,140"	,150"	,160"	,170"	,180"
A+B	Width of door leaf	988	1088	1188	1288	1388	1488	1588	1688	1788	1888
S1	Width of hole in wall	1061	1161	1261	1361	1461	1561	1661	1761	1861	1961
S2	Frame width	1021	1121	1221	1321	1421	1521	1621	1721	1821	1921
S3	Door frame clear width	977	1077	1177	1272	1377	1477	1577	1677	1777	1877
S4	Frame covering width adj. cover list 6 cm/adj. cover list 8 cm	1119 / 1159	1219 / 1259	1319 / 1359	1419 / 1459	1519 / 1559	1619 / 1659	1719 / 1759	1819 / 1859	1919 / 1959	2019 / 2059
H1	Height of door leaf	2030	2030	2030	2030	2030	2030	2030	2030	2030	2030
H2	Height of hole in wall	2073	2073	2073	2073	2073	2073	2073	2073	2073	2073
H3	Frame height	2053	2053	2053	2053	2053	2053	2053	2053	2053	2053
H4	Door frame clear height	2031	2031	2031	2031	2031	2031	2031	2031	2031	2031
H5	Door frame clear height adj. cover list 6 cm/Adj. cover list 8 cm	2102 / 2122	2102 / 2122	2102 / 2122	2102 / 2122	2102 / 2122	2102 / 2122	2102 / 2122	2102 / 2122	2102 / 2122	2102 / 2122

DOUBLE DOORS
- SYMETRIC



DOUBLE DOORS
- NON-SYMETRIC



DOUBLE DOORS
- SIDE LEAF





DOUBLE DOORS

REBATED

REBATED DOUBLE DOORS WITH ADJUSTABLE FRAME

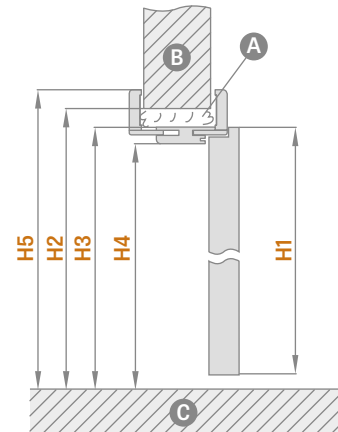
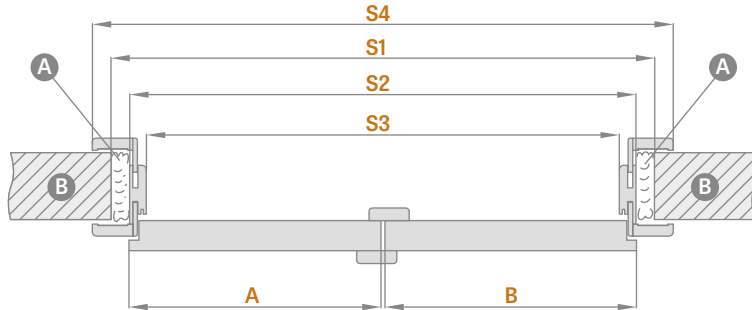

A – mounting foam B – wall C – floor

Adjustable frame	DOUBLE DOORS											
	,90"	,100"	,110"	,120"	,130"	,140"	,150"	,160"	,170"	,180"	,190"	
A+B Width of door leaf	960	1060	1160	1260	1360	1460	1560	1660	1760	1860	1960	
S1 Width of hole in wall	1006	1106	1206	1306	1406	1506	1606	1706	1806	1906	2006	
S2 Frame width	966	1066	1166	1266	1366	1466	1566	1666	1766	1866	1966	
S3 Door frame clear width	922	1022	1122	1222	1322	1422	1522	1622	1722	1822	1922	
S4 Frame covering width adj. cover list 6 cm/adj. cover list 8 cm	1064 / 1104	1164 / 1204	1264 / 1304	1364 / 1404	1464 / 1504	1564 / 1604	1664 / 1704	1764 / 1804	1864 / 1904	1964 / 2004	2064 / 2104	
H1 Height of door leaf	2030	2030	2030	2030	2030	2030	2030	2030	2030	2030	2030	
H2 Height of hole in wall	2060	2060	2060	2060	2060	2060	2060	2060	2060	2060	2060	
H3 Frame height	2040	2040	2040	2040	2040	2040	2040	2040	2040	2040	2040	
H4 Door frame clear height	2018	2018	2018	2018	2018	2018	2018	2018	2018	2018	2018	
H5 Door frame clear height adj. cover list 6 cm/adj. cover list 8 cm	2089 / 2109	2089 / 2109	2089 / 2109	2089 / 2109	2089 / 2109	2089 / 2109	2089 / 2109	2089 / 2109	2089 / 2109	2089 / 2109	2089 / 2109	

REBATED DOUBLE DOORS WITH FIXED FRAME

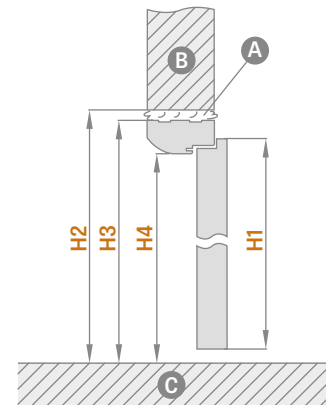
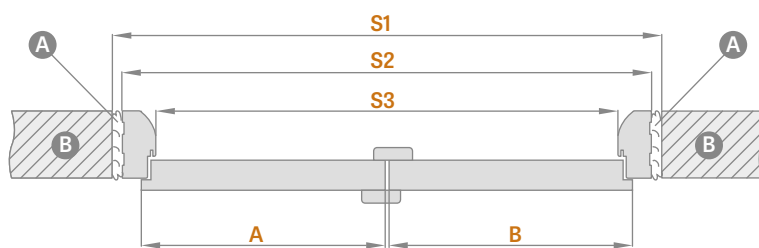

A – mounting foam B – wall C – floor

Fixed frame	DOUBLE DOORS											
	,90"	,100"	,110"	,120"	,130"	,140"	,150"	,160"	,170"	,180"	,190"	
A+B Width of door leaf	960	1060	1160	1260	1360	1460	1560	1660	1760	1860	1960	
S1 Width of hole in wall	1040	1140	1240	1340	1440	1540	1640	1740	1840	1940	2040	
S2 Frame width	1010	1110	1210	1310	1410	1510	1610	1710	1810	1910	2010	
S3 Door frame clear width	922	1022	1122	1222	1322	1422	1522	1622	1722	1822	1922	
H1 Height of door leaf	2030	2030	2030	2030	2030	2030	2030	2030	2030	2030	2030	
H2 Height of hole in wall	2077	2077	2077	2077	2077	2077	2077	2077	2077	2077	2077	
H3 Frame height	2062	2062	2062	2062	2062	2062	2062	2062	2062	2062	2062	
H4 Door frame clear height	2018	2018	2018	2018	2018	2018	2018	2018	2018	2018	2018	



FOLDING DOORS

FOLDING DOOR LEAF

CONSTRUCTION

- door leaf consisting of two parts connected with hidden hinges
- MDF rails covered with two HDF boards or inner wooden rail covered with two HDF boards for PREMIUM and CPL decors
- honeycomb core filling or full plate board (add. charged)

FINISHING

- HDF board covered with decor
- door leaf edge made in standard technology

HARDWARE

- three hidden hinges between door parts
- hidden tracking system in upper and lower parts of doors
- bolt lock for regular key, cylinder, economy lock or bathroom lock

ADDITIONAL CHARGES

filling with solid board

door leaf 100 wide

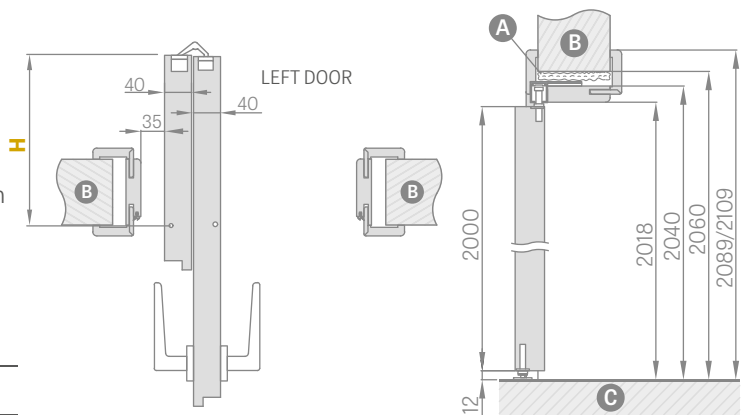
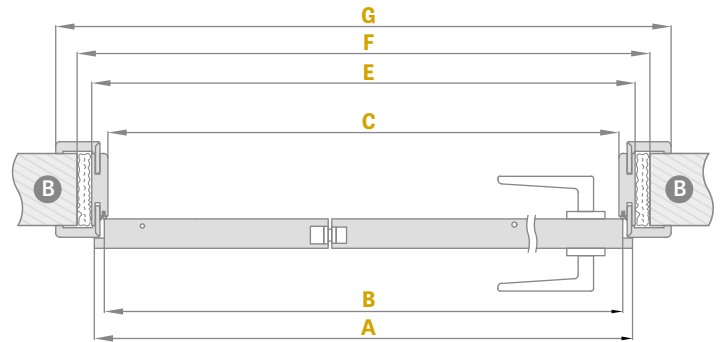

AVAILABLE DOOR WIDTHS

60 70 80 90 100

STANDARD

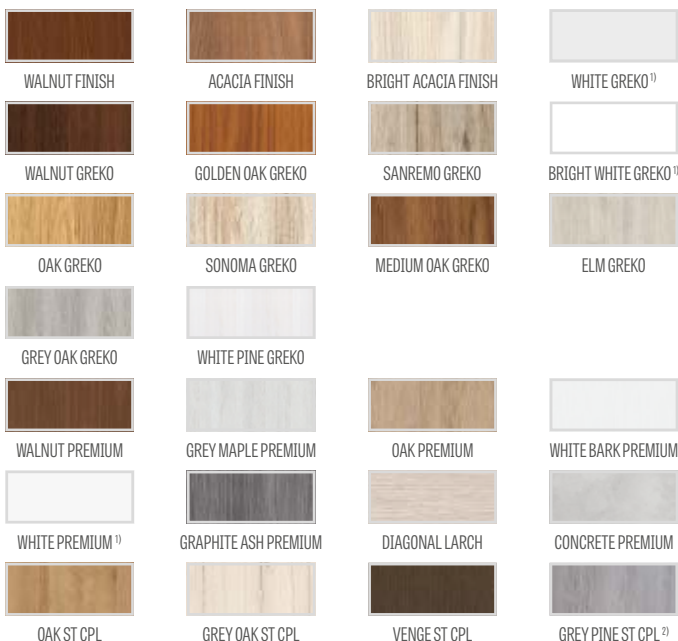

Width of door leaf	A	B	C	E	F	G	H
„60”	641	614	604	648	688	746*/786**	152,5
„70”	741	714	704	748	788	846*/886**	202,5
„80”	841	814	804	848	888	946*/986**	252,5
„90”	941	914	904	948	988	1046*/1086**	302,5
„100”	1041	1014	1004	1048	1088	1146*/1186**	352,5

* adj. cover list 6 cm / **adj. cover list 8 cm, connection only at 45°

Range of regulation min.-max (mm)
80-100
100-120
120-140
140-160
160-180
180-200
200-220
220-240
240-260

Range of regulation min.-max (mm)
260-280
260-300
280-300
300-320
320-340
340-360
360-380
380-400
400-420

¹⁾ white foil imitating painting surface

²⁾ available from 1st April 2019

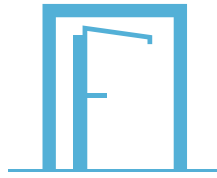

HIDDEN DOORS SYSTEM

OPENING INSIDE AND OUTSIDE



REBATED AND NON-REBATED DOOR LEAF

HIDDEN ALUMINIUM FRAME

CONSTRUCTION

- rebated or non-rebated door leaf
- wooden rail covered with two HDF boards
- honeycomb core filling or full plate board (add. charged)

FINISHING

- HDF board covered with diagonal foil, PREMIUM or to be painted/taped
- the edge of door leaf made in rebate or non-rebate technology

HARDWARE

- two hidden hinges set in the door frame
- magnetic lock in rebated door leaf and lock for key, cylinder, economy or with blockage in non-rebated door leaf

ADDITIONAL CHARGES

door frame in white decor **NEW**

door leaf painted white titanium UV **NEW**

filling with solid board

additional bottom construction bar (offers possibility of an individual trim of door leaf up to 8 cm)

metal ventilation grill round and square (4 pieces)
finishing: brushed nickel or patina, white and black

plastic ventilation sleeves (4 pieces)

ventilation cut lub ventilation grill

door leaf 100 wide

automatic door seal



WALNUT
PREMIUM



GREY MAPLE
PREMIUM



OAK
PREMIUM



WHITE BARK
PREMIUM



GRAPHITE ASH
PREMIUM



CONCRETE
PREMIUM



DIAGONAL
LARCH



WHITE
PREMIUM ¹⁾



WHITE BASE ²⁾



WHITE
TITANIUM UV

AVAILABLE DOOR WIDTHS

60 70 80 90 100

¹⁾ white foil imitating painting surface, ²⁾ applied as the base to be painted or taped



HIDDEN DOORS SYSTEM

REBATED DOOR LEAF OPENING INSIDE

REBATED DOOR LEAF

ALUMINIUM HIDDEN FRAME

STANDARD DIMENSIONS FOR REBATED DOOR LEAFS OPENING INSIDE

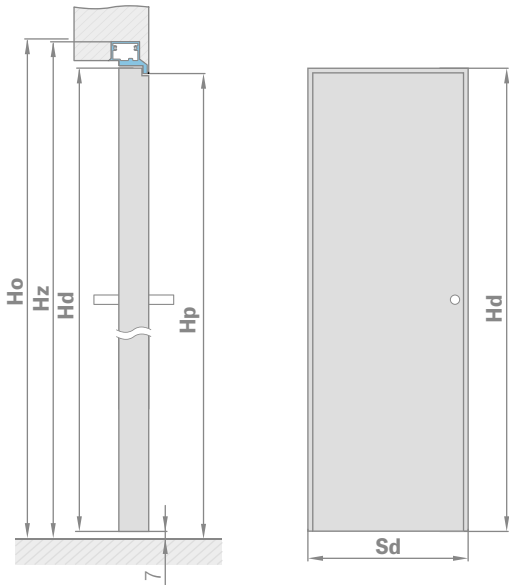

Door width	Construction hole width	Frame exterior width	Opening width
Sd [mm]	So [mm]	Sz [mm]	Sp [mm]
644	724	714	629
744	824	814	729
844	924	914	829
944	1024	1014	929
1044	1124	1114	1029

Door height	Construction hole height	Frame exterior height	Opening height
Hd [mm]	Ho [mm]	Hz [mm]	Hp [mm]
2030	2079	2072	2030

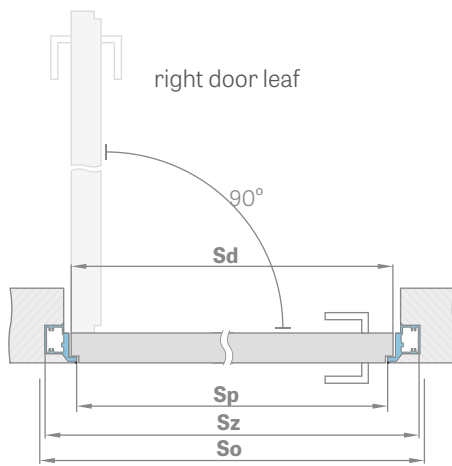

GYPSUM BOARD MOUNTING

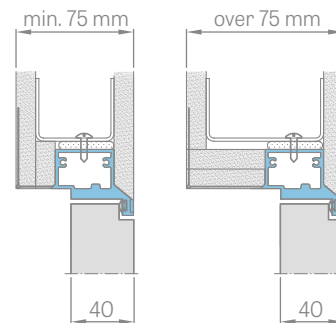

INTERSECTION OF ALUMINIUM FRAME

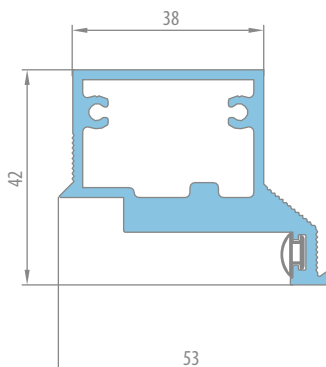

WALL MOUNTING

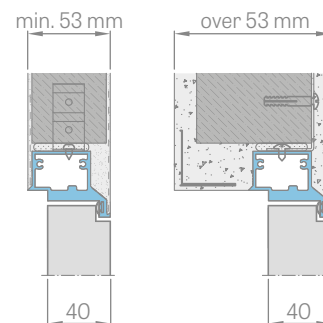



HIDDEN DOORS SYSTEM

NON-REBATED DOOR LEAF OPENING OUTSIDE

NON-REBATED DOOR LEAF

ALUMINIUM HIDDEN FRAME

STANDARD DIMENSIONS FOR NON-REBATED DOOR LEAFS OPENING OUTSIDE

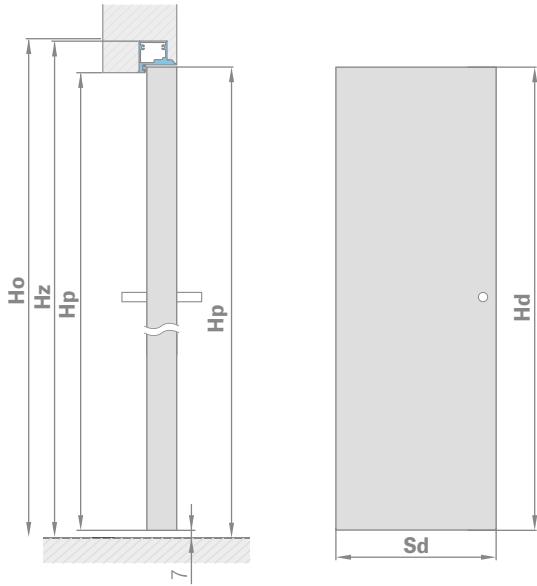

Door width	Construction hole width	Frame exterior width	Opening width
Sd [mm]	So [mm]	Sz [mm]	Sp [mm]
644	724	714	629
744	824	814	729
844	924	914	829
944	1024	1014	929
1044	1124	1114	1029

Door height	Construction hole height	Frame exterior height	Opening height
Hd [mm]	Ho [mm]	Hz [mm]	Hp [mm]
2020	2069	2062	2020

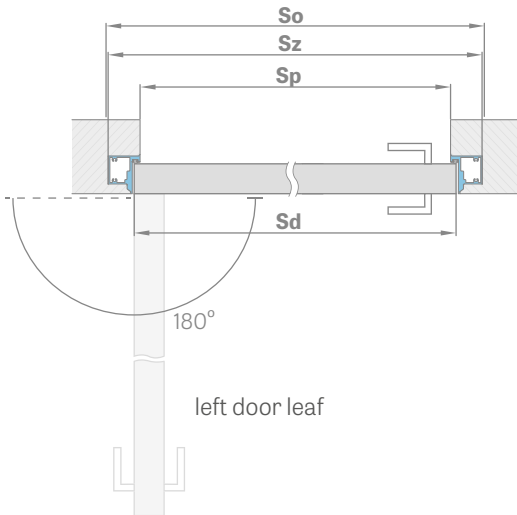

GYPSUM BOARD MOUNTING

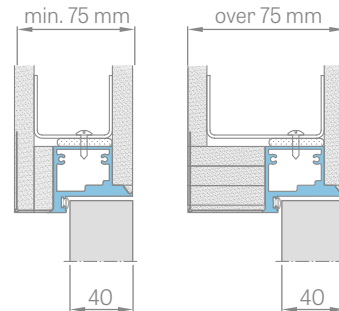

INTERSECTION OF ALUMINIUM FRAME

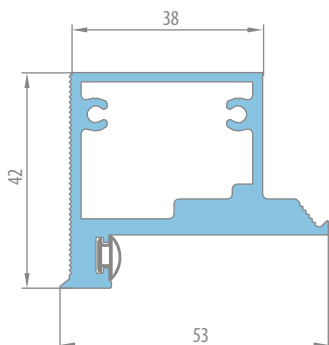

WALL MOUNTING

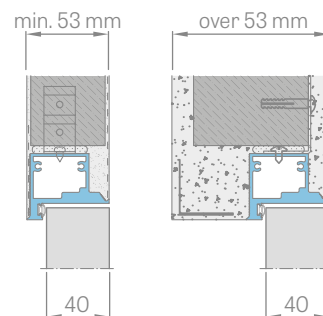



TRANSOMS

GENERAL INFORMATION

Transoms are factory-made and they are fixed with protection glass VSG 331 milk or transparent.
(To be specified when making an order)

AVAILABLE TRANSOMS:

TYPES OF TRANSOMS

TO FIXED FRAME
TO ADJUSTABLE FRAME
TO SINGLE DOOR LEAFS
TO DOUBLE DOORS

SINGLE DOOR LEAFS with side, top and corner transoms

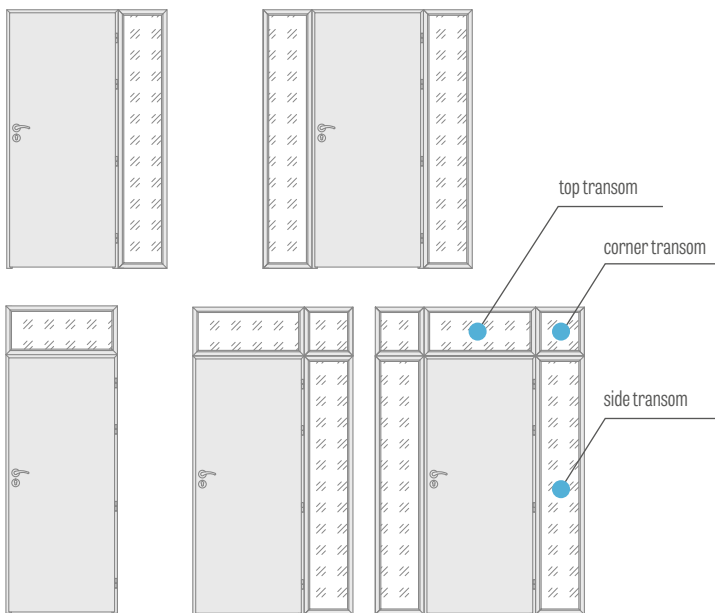

DOUBLE DOOR LEAFS with side, top and corner transoms

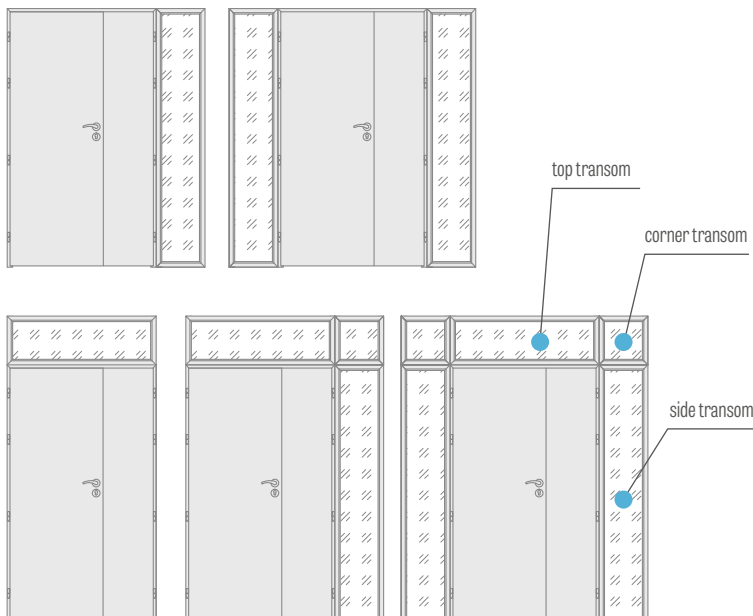

Side transoms of adjustable frame
Adj. cover list 6cm/Adj. cover list 8cm

„30“ „40“ „50“ „60“

446/486, 546/586, 646/686, 746/786

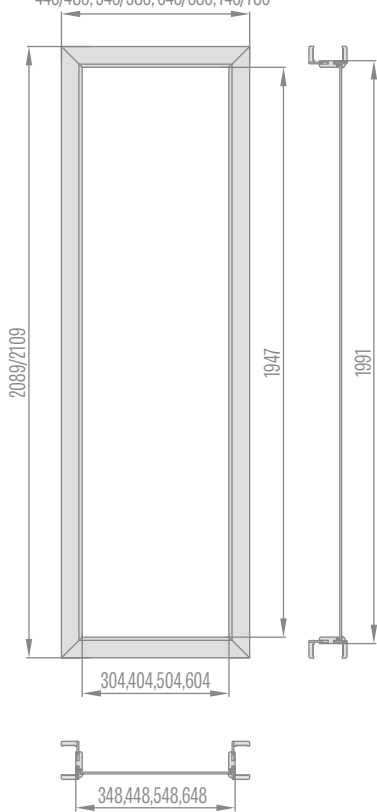

Corner transoms of adjustable frame
Adj. cover list 6cm/Adj. cover list 8cm

„30“ „40“ „50“ „60“

446/486, 546/586, 646/686, 746/786

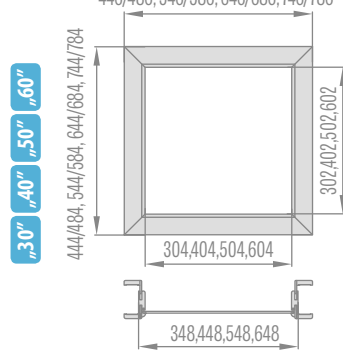

Top transoms of adjustable frame to single door leaves
Adj. cover list 6cm/Adj. cover list 8cm

„60“ „70“ „80“ „90“ „100“

746/786, 846/886, 946/986, 1046/1086, 1146/1186

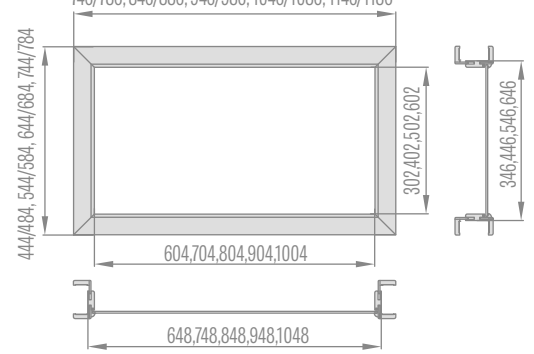

Top transoms of adjustable frame to double doors Adj. cover list 6cm/Adj. cover list 8cm

„90“ „100“ „110“ „120“ „130“ „140“ „150“ „160“ „170“ „180“ „190“

1066/1106, 1166/1206, 1266/1306, 1366/1406, 1466/1506, 1566/1606,
1666/1706, 1766/1806, 1866/1906, 1966/2006, 2066/2106

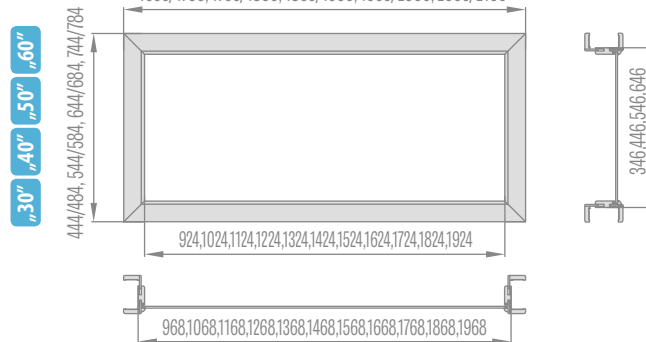

Side transoms of fixed frame

„30“ „40“ „50“ „60“

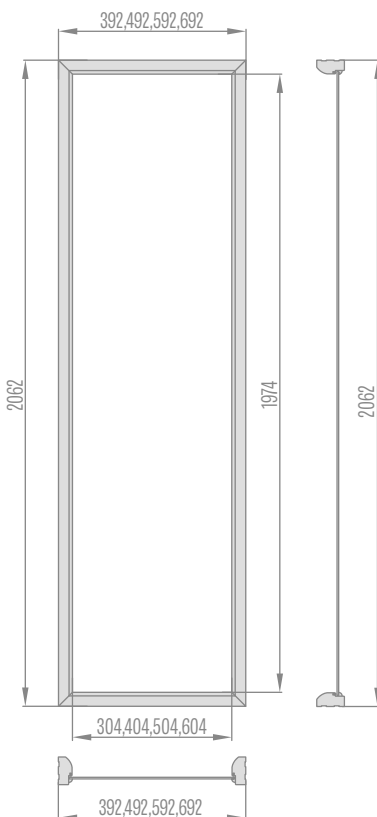

Corner transoms of fixed frames

„30“ „40“ „50“ „60“

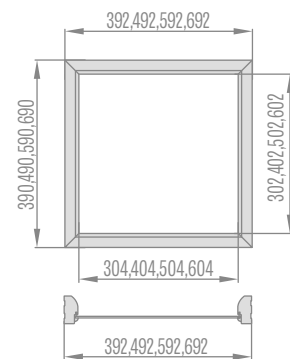

Top transoms of fixed frames to single door leaves

„60“ „70“ „80“ „90“ „100“

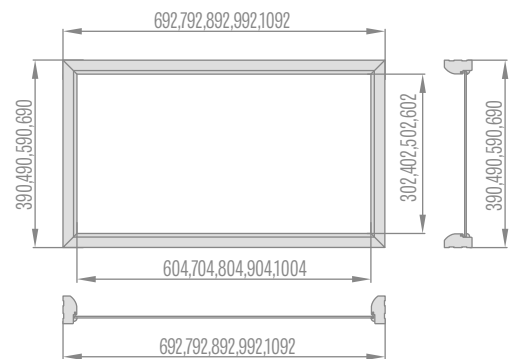

Top transoms of fixed frame to double doors

„90“ „100“ „110“ „120“ „130“ „140“ „150“ „160“ „170“ „180“ „190“



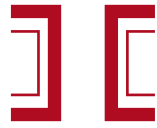

DOOR FRAMES

- Rebated adjustable and fixed frames can be applied to all kind of interior doors by ERKADO made in board STANDARD and SOFT technology as well as in STILE technology.
- Non-rebated adjustable frame can be applied to interior doors made in board technology as well as STILE technology. These frames include three hidden hinges.
- Frames are made of high quality MDF and are covered with durable woodgrain foil or covered with UV paint.
- Depending on technology, the frames are covered with the following types of finishing: FINISH, GREKO, CPL, PREMIUM, PCV and UV paint.
- Frames to STILE doors have default third hinge.
- Each set of frame includes: separate elements of frame, hinges, screws. Particular elements have necessary drillings in the connection spots.
- Each set includes assembly instruction and guarantee card.
- Fixed frame to Herse collection is square and has wooden core.

ADJUSTABLE FRAME REBATED LEAFS



ADJUSTABLE CASING TO METAL FRAME



ADJUSTABLE FRAME NON-REBATED LEAFS



SOFT FIXED FRAME REBATED LEAFS



REGULAR SQUARE TO ADJUSTABLE FRAME

Adj. cover list 6 cm/Adj. cover list 8 cm

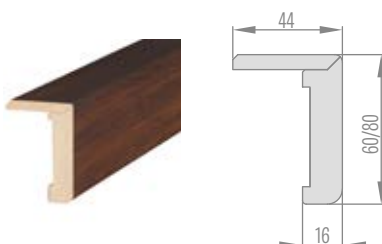

SQUARE WITH EXTENDED FEATHER TO ADJUSTABLE FRAME

Adj. cover list 6 cm/Adj. cover list 8 cm

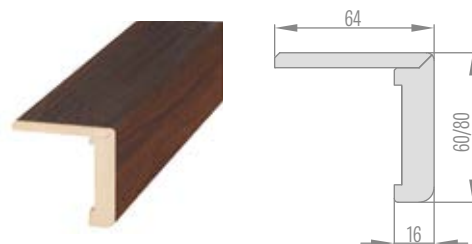



FIXED FRAME

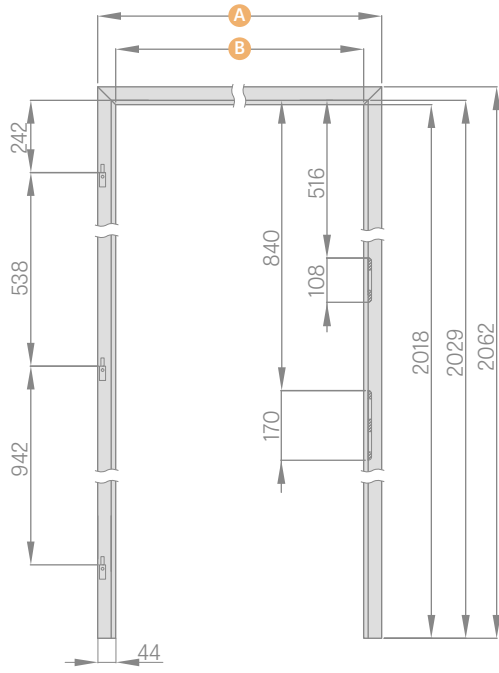

	.60"	.70"	.80"	.90"	.100"
A	692	792	892	992	1092
B	604	704	804	904	1004

ADJUSTABLE FRAME

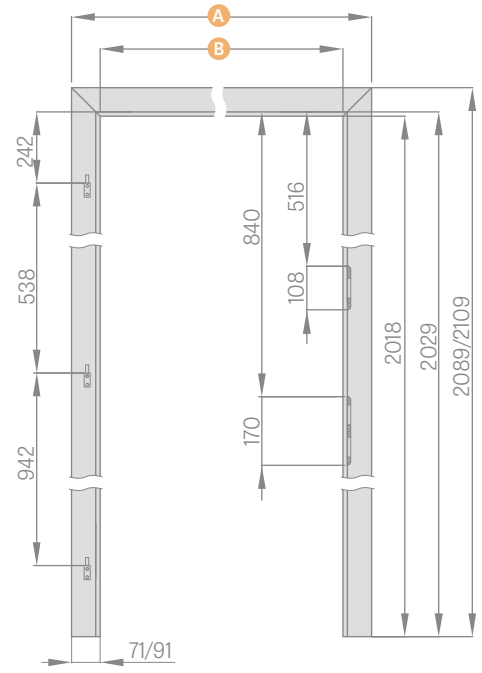

	.60"	.70"	.80"	.90"	.100"
A	746 / 786	846 / 886	946 / 986	1046 / 1086	1146 / 1186
B	604	704	804	904	1004

Adj. cover list 6cm/Adj. cover list 8cm

TUNNEL ADJUSTABLE FRAME

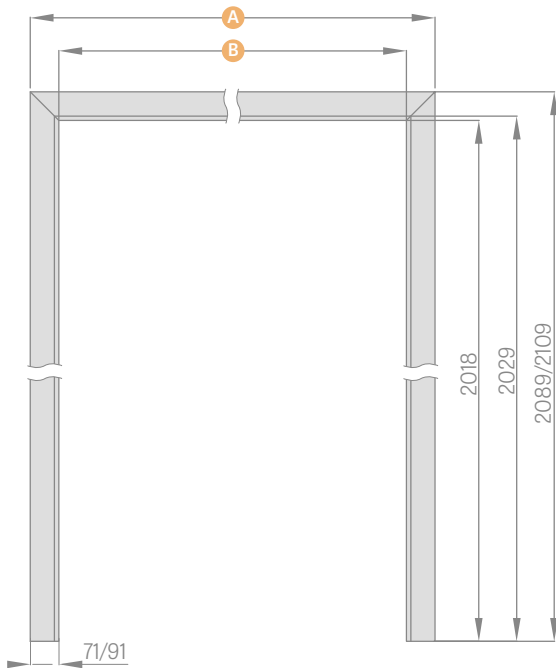

	.60"	.70"	.80"	.90"	.100"	.110"	.120"
A	746 / 786	846 / 886	946 / 986	1046 / 1086	1146 / 1186	1246 / 1286	1346 / 1386
B	604	704	804	904	1004	1104	1204

	.130"	.140"	.150"	.160"	.170"	.180"	.190"
A	1446 / 1486	1546 / 1586	1646 / 1686	1746 / 1786	1846 / 1886	1946 / 1986	2046 / 2086
B	1304	1404	1504	1604	1704	1804	1904

Adj. cover list 6cm/Adj. cover list 8cm

FRAME CASING

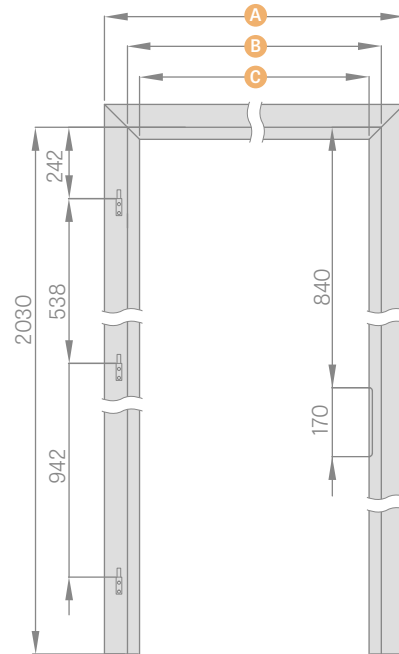

	.60"	.70"	.80"	.90"	.100"
A	737	837	937	1037	1137
B	624	724	824	924	1024
C	564	664	764	864	964



FIXED FRAME TO DOUBLE DOORS

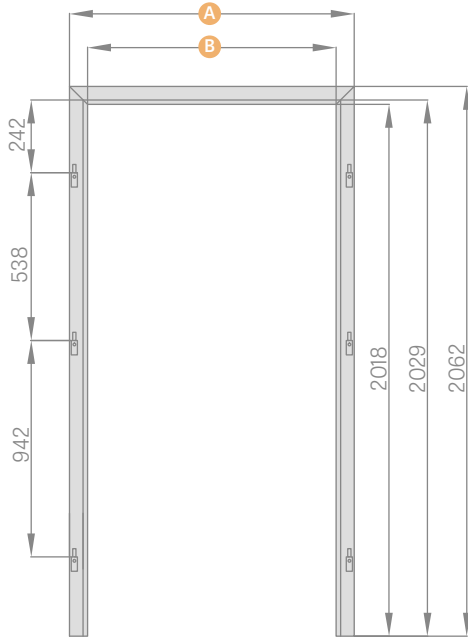

	,90"	,100"	,110"	,120"	,130"	,140"
A	1010	1110	1210	1310	1410	1510
B	922	1022	1122	1222	1322	1422

	,150"	,160"	,170"	,180"	,190"
A	1610	1710	1810	1910	2010
B	1522	1622	1722	1822	1922

ADJUSTABLE FRAME TO DOUBLE DOORS

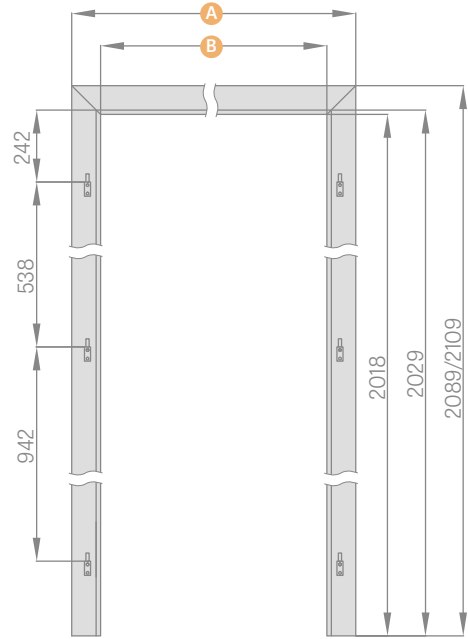

	,90"	,100"	,110"	,120"	,130"	,140"
A	1064/1104	1164/1204	1264/1304	1364/1404	1464/1504	1564/1604
B	922	1022	1122	1222	1322	1422

	,150"	,160"	,170"	,180"	,190"
A	1664/1704	1764/1804	1864/1904	1964/2004	2064/2104
B	1522	1622	1722	1822	1922

Adj. cover list 6 cm/Adj. cover list 8cm

FIXED FRAME TO GLASS DOORS

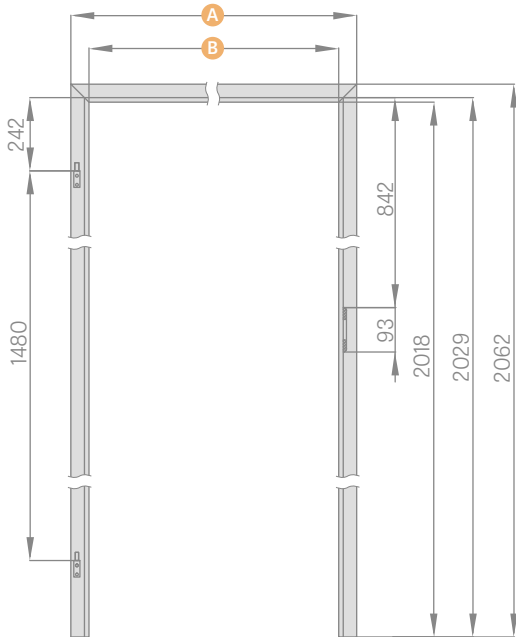

	,60"	,70"	,80"	,90"
A	692	792	892	992
B	604	704	804	904

ADJUSTABLE FRAME TO GLASS DOORS

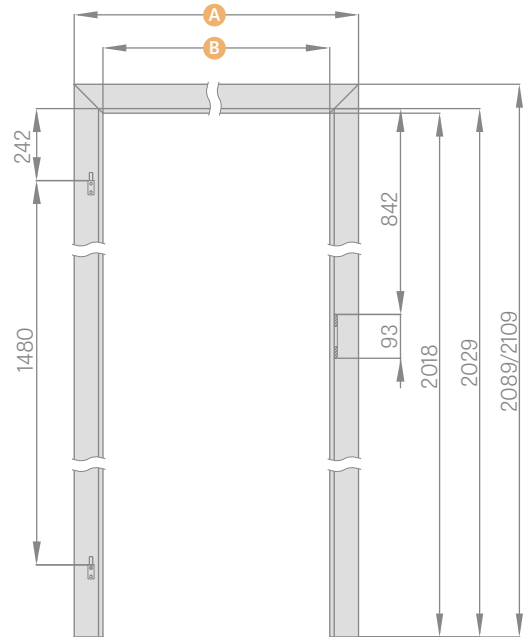

	,60"	,70"	,80"	,90"
A	746/786	846/886	946/986	1046/1086
B	604	704	804	904

Adj. cover list 6 cm/Adj. cover list 8cm

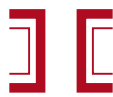

ADJUSTABLE TUNNEL FRAMES

REBATED, NON-REBATED

DOOR FRAMES TUNEL

Tunnel frame is an adjustable frame or fixed frame without any hardware. It is constructed with one horizontal and two vertical beams. It can be applied to decorate in-door spaces as the element of protection to wall edges.

Nevertheless more often it is used for the esthetical reasons as the decoration of the whole interior.

Rebated and non-rebated adjustable and fixed tunnel frames are also used in ERKADO sliding systems.

Non-rebated adjustable tunnel frames are not used in sliding systems.

Depending on the system we differentiate:

TUNEL DO SP1N	Tunnel frame to single on-wall sliding system
TUNEL DO SP2N	Tunnel frame to double on-wall sliding system
TUNEL DO SP1C.100	Tunnel frame to single in-wall sliding system to PANEL 100 wide
TUNEL DO SP2C.100	Tunnel frame to double in-wall sliding system to PANEL 100 wide
TUNEL DO SP1C.125	Tunnel frame to single in-wall sliding system to PANEL 125 wide
TUNEL DO SP2C.125	Double in-wall sliding system to PANEL 125 wide
mounting ZN1	Wall mounting on one side to single door leaf systems SP1C.100 and SP1C.125
mounting ZN2	Wall mounting on one side to double door leaf systems SP2C.100 and SP2C.125

REBATED ADJUSTABLE TUNNEL FRAMES

	,60"	,70"	,80"	,90"	,100"	,110"	,120"	,130"	,140"	,150"	,160"	,170"	,180"	,190"
Width of hole in wall	688	788	888	988	1088	1188	1288	1388	1488	1588	1688	1788	1888	1988
Tunnel exterior size	648	748	848	948	1048	1148	1248	1348	1448	1548	1648	1748	1848	1948
Tunnel clear width	604	704	804	904	1004	1104	1204	1304	1404	1504	1604	1704	1804	1904
Tunnel covering width Adj. cover list 6 cm/Adj. cover list 8 cm	746/ 786	846/ 886	946/ 986	1046/ 1086	1146/ 1186	1246/ 1286	1346/ 1386	1446/ 1486	1546/ 1586	1646/ 1686	1746/ 1786	1846/ 1886	1946/ 1986	2046/ 2086
Height of hole in wall	2060	2060	2060	2060	2060	2060	2060	2060	2060	2060	2060	2060	2060	2060
Tunnel exterior height	2040	2040	2040	2040	2040	2040	2040	2040	2040	2040	2040	2040	2040	2040
Tunnel clear height	2018	2018	2018	2018	2018	2018	2018	2018	2018	2018	2018	2018	2018	2018
Tunnel covering height Adj. cover list 6 cm/Adj. cover list 8 cm	2089/ 2109	2089/ 2109	2089/ 2109	2089/ 2109	2089/ 2109	2089/ 2109	2089/ 2109	2089/ 2109	2089/ 2109	2089/ 2109	2089/ 2109	2089/ 2109	2089/ 2109	2089/ 2109

NON-REBATED ADJUSTABLE TUNNEL FRAMES

	,60"	,70"	,80"	,90"	,100"	,110"	,120"	,130"	,140"	,150"	,160"	,170"	,180"
Width of hole in wall	713	813	913	1013	1113	1213	1313	1413	1513	1613	1713	1813	1913
Tunnel exterior size	673	773	873	973	1073	1173	1273	1373	1473	1573	1673	1773	1873
Tunnel clear width	629	729	829	929	1029	1129	1229	1329	1429	1529	1629	1729	1829
Tunnel covering width Adj. cover list 6 cm/Adj. cover list 8 cm	771/ 811	871/ 911	971/ 1011	1071/ 1111	1171/ 1211	1271/ 1311	1371/ 1411	1471/ 1511	1571/ 1611	1671/ 1711	1771/ 1811	1871/ 1911	1971/ 2011
Height of hole in wall	2073	2073	2073	2073	2073	2073	2073	2073	2073	2073	2073	2073	2073
Tunnel exterior height	2053	2053	2053	2053	2053	2053	2053	2053	2053	2053	2053	2053	2053
Tunnel clear height	2031	2031	2031	2031	2031	2031	2031	2031	2031	2031	2031	2031	2031
Tunnel covering height Adj. cover list 6 cm/Adj. cover list 8 cm	2102/ 2122	2102/ 2122	2102/ 2122	2102/ 2122	2102/ 2122	2102/ 2122	2102/ 2122	2102/ 2122	2102/ 2122	2102/ 2122	2102/ 2122	2102/ 2122	2102/ 2122



METAL FRAMES

TO BOARD AND STILE DOORS

ADJUSTABLE METAL FRAME (EMBRACING), metal sheet 1.5 mm thick

welded and painted RAL 9010, 9016, 8003, 8017, 7016, 7047, 1001

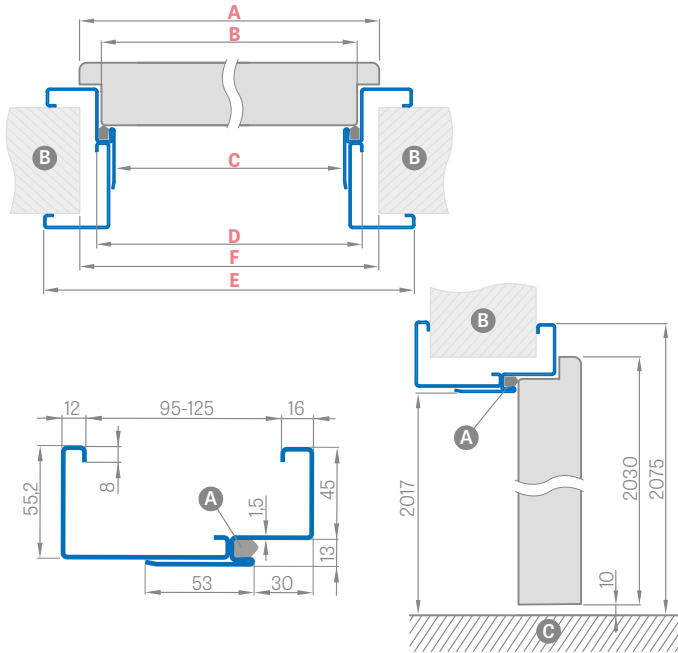

Width of door leaf	A	B	C	D	E	F
„60”	644	617	601	627	717	695
„70”	744	717	701	727	817	795
„80”	844	817	801	827	917	895
„90”	944	917	901	927	1017	995
„100”	1044	1017	1001	1027	1117	1095

Adjustment range min.-max (mm)
95-125
125-155
155-185
185-215
215-245
245-275
275-305

METAL SQUARE FRAME, LARGE SIZE, metal sheet 1.2 mm thick

welded and painted RAL 9010, 9016, 8003, 8017, 7016, 7047, 1001

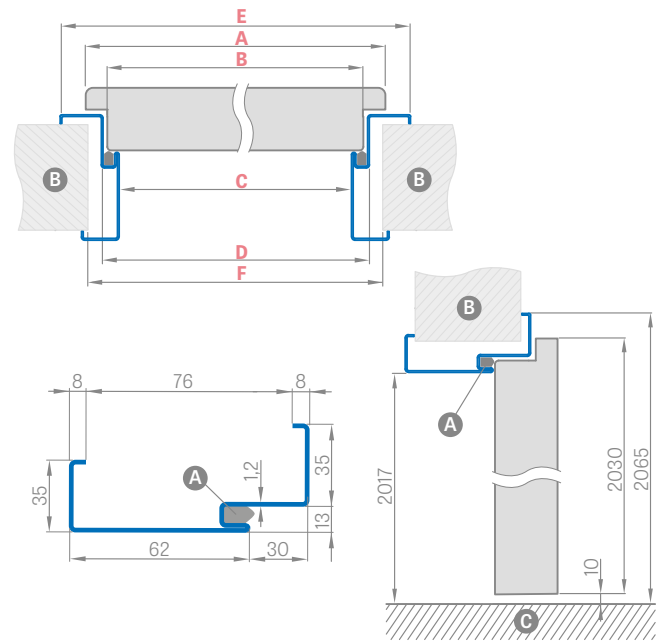

Width of door leaf	A	B	C	D	E	F
„60”	644	617	601	627	697	683
„70”	744	717	701	727	797	783
„80”	844	817	801	827	897	883
„90”	944	917	901	927	997	983
„100”	1044	1017	1001	1027	1097	1083

LAUNCHING EDGE FRAME

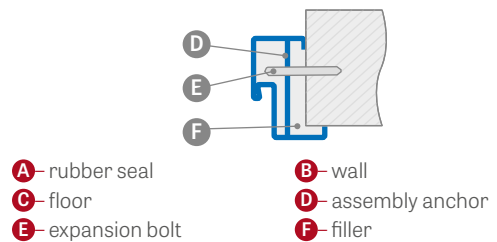

ADDITIONAL CHARGES

electric strike

enforcement for self-lock

finishing with galvanised steel

adjustable frame 100

fixed frame 100

double doors frame

RAL



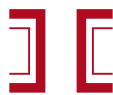

ADJUSTABLE FRAME CASING

TO STEEL FRAME

LOCATION OF DOOR KNOB IN FRAME CASING

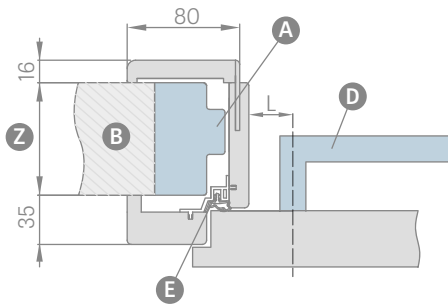

L - distance from knob axis to frame edge

L = 23 mm for board doors, ASTRA door knobs page 78

L = 28 mm for STILE doors (all door knobs METAL-BUD, ERKADO, HOPPE, TUPAI i GAMET page 106-112)

ATTENTION:

Before applying the door knob please check dimensions of the door knob plate.

Casing frame of range above 205 mm consists of two elements and of range above 330 mm it consists of three elements

AVAILABLE WIDTHS OF FRAME CASINGS:

60 70 80 90 100

Adjustment range min.-max (mm)	
1 elements	80-105
	105-130
	130-155
	155-180
	180-205
2 elements	205-230
	230-255
	255-280
	280-305
	305-330
3 elements	330-355
	355-380
	380-405
	405-430
	430-455

TECHNICAL PICTURE OF FRAME CASING

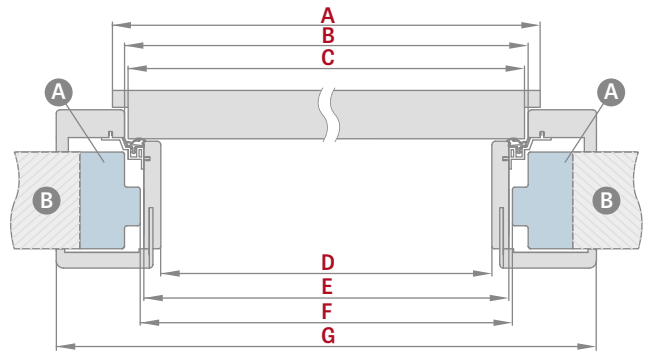

Width of door leaf	A	B	C	D	E	F	G
„60”	644	624	618	564	592	598	737
„70”	744	724	718	664	692	698	837
„80”	844	824	818	764	792	798	937
„90”	944	924	918	864	892	898	1037
„100”	1044	1024	1018	964	992	998	1137

F – minimal dimension of clear steel frame width on which we install frame casing. This dimension can be bigger than recommended by max. 20 mm. With bigger clear width one should pay attention whether the trims can properly cover the walls.

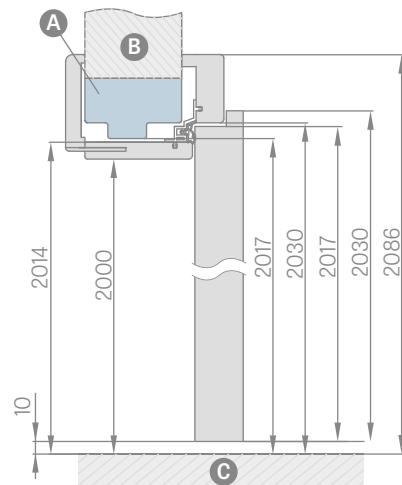

- A** – steel frame
- B** – wall
- C** – floor
- D** – knob
- E** – aluminium profile with gasket
- Z** – zakres od 80 mm do 255 mm

- Square with extended feather - not available
- Prices of tunnel frames of widths: 60, 70, 80, 90, 100 are at prices of casing frames
- Tunnel has the same dimensions as casing frame (there are no drills for hinge and lock plate however it is equipped with the seal)



REVERSE FRAME

REVERSE DOOR LEAFS

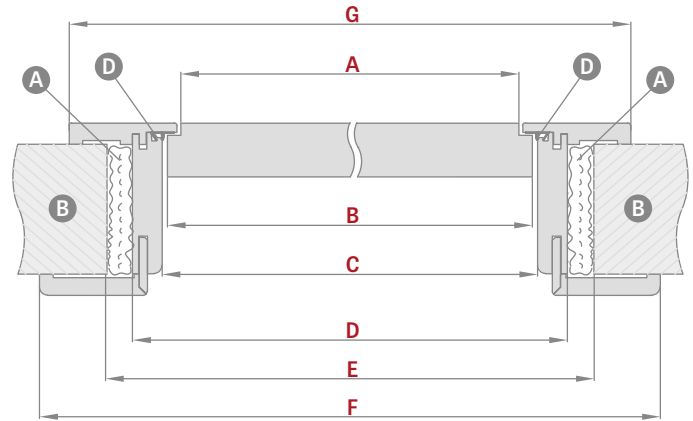
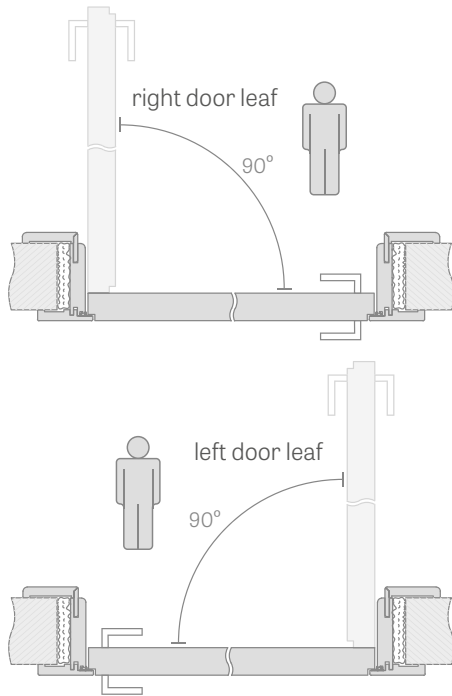

ADJUSTMENT RANGE OF REVERSE FRAME

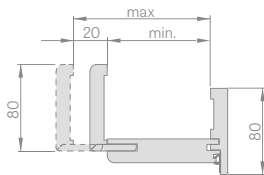

Adjustment range min.-max (mm)	
1 element	75-95
	95-115
	115-135
	135-155
	155-175
2 elements	175-195
	195-215
	215-235
	235-255
	255-275
	275-295
	295-315
	315-335
335-355	

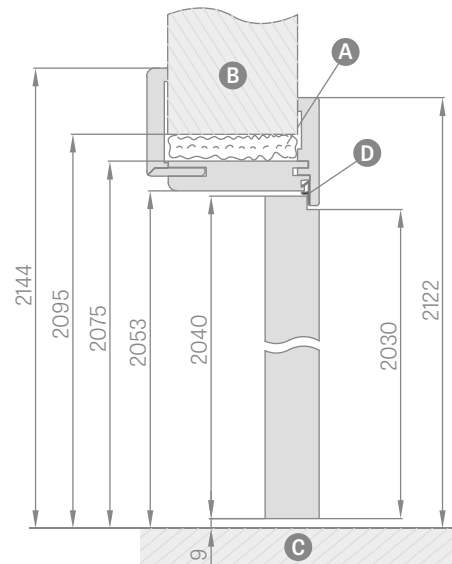

Width of door leaf	A	B	C	D	E	F	G
„60“	644	664	672	716	756	854	811
„70“	744	764	772	816	856	954	911
„80“	844	864	872	916	956	1054	1011
„90“	944	964	972	1016	1056	1154	1111
„100“	1044	1064	1072	1116	1156	1254	1211

A mounting foam **B** wall **C** floor **D** rubber seal

- Frame to reverse door leafs is available only with the square 8 cm connected at 45 angle
- Available decors: GREKO, PREMIUM, CPL and WHITE TITANIUM UV
- Frame of adjustment above 255 mm consists of two elements



ADJUSTABLE FRAME

NON-REBATED DOOR LEAFS

ADJUSTABLE FRAME RANGE 80-95 mm

Adj. cover list 6 cm / Adj. cover list 8 cm

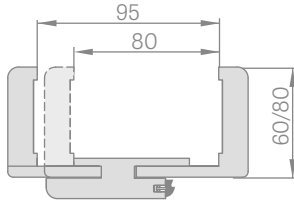

In the frame of range 80-95mm the feather of the square should be trimmed individually by the Customer to desired dimension.

FRAME CONNECTION

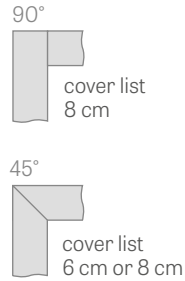

TECHNICAL PICTURE OF ADJUSTABLE FRAME

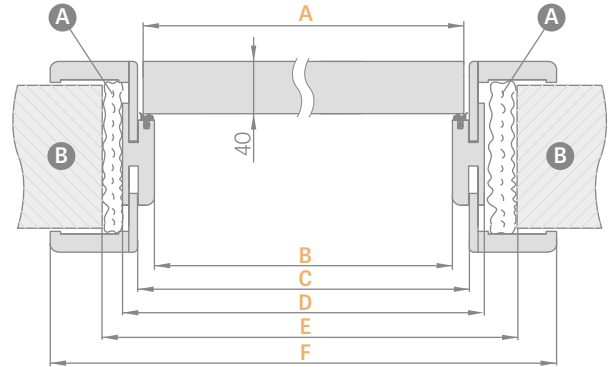

ADJUSTABLE FRAME ADJUSTMENT RANGE

Adj. cover list 6 cm / Adj. cover list 8 cm

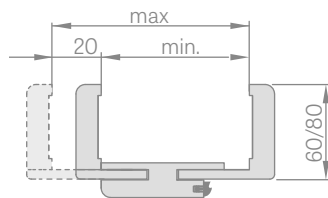

Width of door leaf	A	B	C	D	E	F
„60“	644	629	651	673	723	771*/811**
„70“	744	729	751	773	823	871*/911**
„80“	844	829	851	873	923	971*/1011**
„90“	944	929	951	973	1023	1071*/1111**
„100“	1044	1029	1051	1073	1123	1171*/1211**

* Adj. cover list 6 cm/ **Adj. cover list 8 cm

Adjustment range min.-max (mm)	
1 element	80-95
	95-115
	115-135
	135-155
	155-175
	175-195
2 elements	195-215
	215-235
	235-255
	255-275
	275-295
	295-315
2 elements	315-335
	335-355
	355-375
	375-395
395-415	

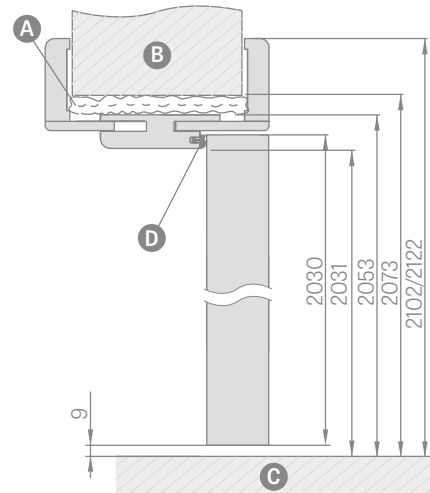

A mounting foam B wall C floor D rubber seal

- Connecting the adjustable frame to an angle of 90 degrees is possible only with the list cover 8 cm thick
- Adjustable frame of range more than 295 mm consists of two elements
- Prices of tunnel type of frame of widths: 60, 70, 80, 90, 100 are at the prices of adjustable frame for rebated doors
- Prices of tunnel type of frame of widths: 110, 120, 130, 140, 150, 160, 170, 180, 190 are at the prices of adjustable frame to rebated double doors.

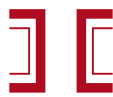

FIXED FRAME

REBATED DOOR LEAFS

FIXED FRAME SOFT TECHNOLOGY



TECHNICAL PICTURE OF FIXED FRAME

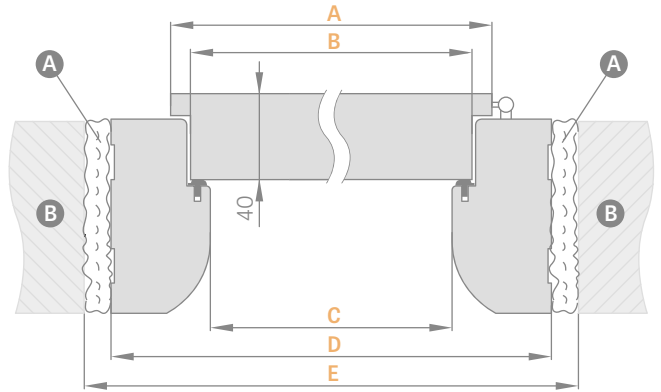

MASKING TRIM

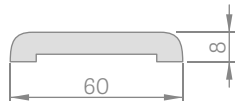

Width of door leaf	A	B	C	D	E
„60“	644	618	604	692	722
„70“	744	718	704	792	822
„80“	844	818	804	892	922
„90“	944	918	904	992	1022
„100“	1044	1018	1004	1092	1122

QUARTER ROUND

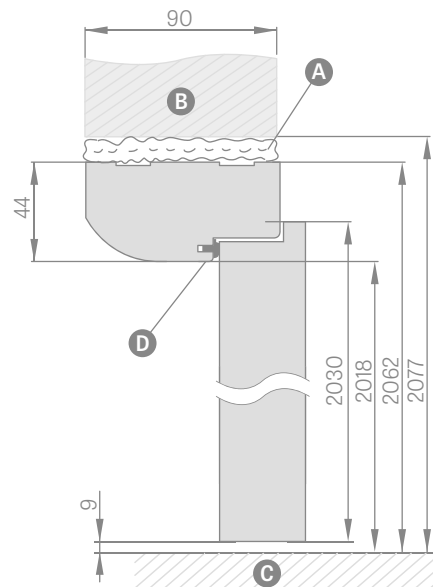
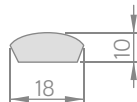

A mounting foam **B** wall **C** floor **D** rubber seal

SKIRTING BOARD length 2.40 L.M.

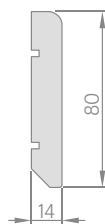

- Skirting board is made of humidity resistant MDF. It comes in: WHITE TITANIUM UV, decors: WHITE GREKO, WALNUT GREKO, BRIGHT WHITE GREKO and PREMIUM decors as well as in base layer ready to be painted.
- Assembly - it works on the glue

- Fixed non-rebated door frame - not applicable



ADJUSTABLE FRAME

REBATED DOOR LEAFS



Adjustable frame
Of range more than 280 mm

Adjustable frame of range more than 280 mm consists of two elements (not applicable to range 260-300 mm), and above 400 mm it consists of three elements and they are disproportionately placed.

* concerns board and STILE doors

ADJUSTMENT RANGE

Adj. cover list 6 cm / Adj. cover list 8 cm

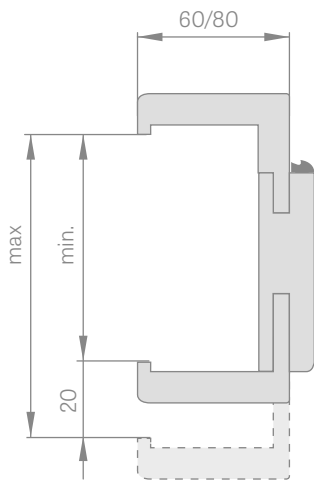

FRAME CONNECTION

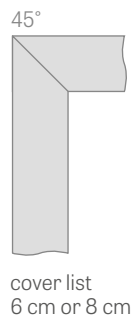
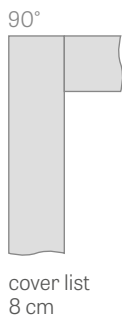

TECHNICAL PICTURE OF ADJUSTABLE FRAME

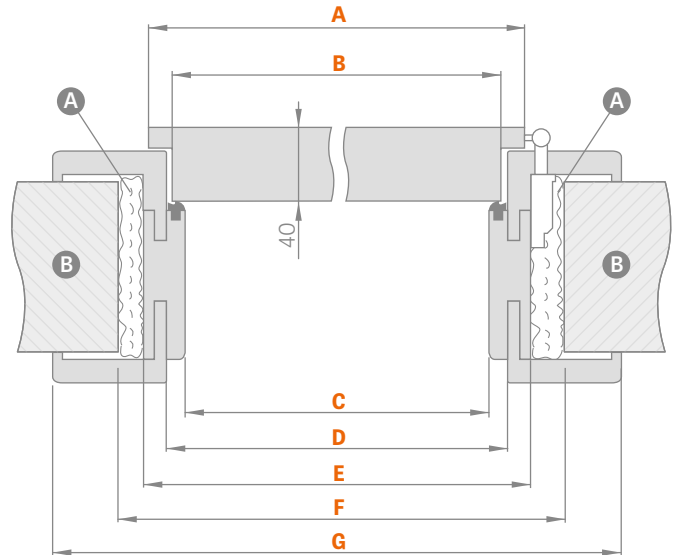

Width of door leaf	A	B	C	D	E	F	G
„60“	644	618	604	626	648	688	746*/786**
„70“	744	718	704	726	748	788	846*/886**
„80“	844	818	804	826	848	888	946*/986**
„90“	944	918	904	926	948	988	1046*/1086**
„100“	1044	1018	1004	1026	1048	1088	1146*/1186**

* adj. cover list 6 cm / ** adj. cover list 8 cm

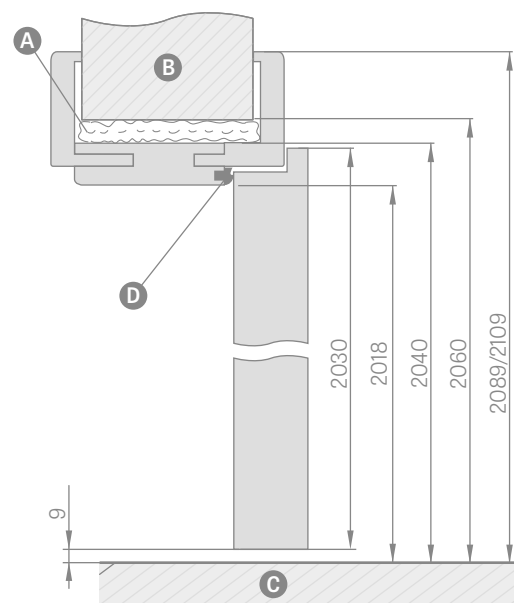

Ⓐ mounting foam Ⓑ wall Ⓒ floor Ⓓ rubber seal

	Adjustment range min.-max (mm)
1 element	80-100
	100-120
	120-140
	140-160
	160-180
	180-200
	200-220
	220-240
	240-260
	260-280
2 elements	260-300
	280-300
	300-320
	320-340
	340-360
	360-380
3 elements	380-400
	400-420

- Connecting the adjustable frame to an angle of 90 degrees is possible only with the list cover 8 cm thick
- It is possible to make frames up to range 500-520 mm
- Prices of tunnel type of frame of widths: 60, 70, 80, 90, 100 are at the prices of adjustable frame for rebated doors
- Prices of tunnel type of frame (for rebated and non-rebated leaves) of widths: 110, 120, 130, 140, 150, 160, 170, 180, 190 are at the prices of adjustable frame to rebated double doors.



ERKADO Sp. z o.o.

Gościeradów-Folwark Osiedle POM 8

TAX NO 715-194-27-90

e-mail: biuro@erkado.pl

www.erkado.pl

POLAND

INTERIOR DOORS

tel. +48 15 838 10 57

fax +48 15 838 18 84

EXTERIOR DOORS

tel. +48 15 845 33 88

fax +48 15 845 34 05

www.erkado.pl

The guarantee and assembly cards are attached to the product.

This catalogue is only of the informative usage and includes up-to-date range of available products.

The producer has the right to change the prices and the range of available goods without official notification.

The colour samples can differ in reality with those presented in this catalogue. Please consult the colours with the original samples that can be accessed at our distributors. We have the right to printing errors.

This catalogue does not constitute an offer, in the context of law and is published only for the informative purposes. Technical certificates can be accessed and downloaded from our website www.erkado.pl

The choice of proper door leafs should be based on the technical project of the given space/room, worked upon with consideration of all legal housing norms and regulations being in law. ERKADO offers several possibilities however the choice is left to the Purchaser due to the fact that only the Purchaser or person operating on Its behalf knows the purpose and exploitation conditions of the ordered product.



Scan code and download this catalogue
on to Your smartphone/tablet [pdf]

PREPARED BY: www.multikolor.com.pl

THE COLOURS PRESENTED IN THE CATALOGUE MIGHT VARY FROM REALITY